

# BRIO ULTRA HD BUSINESS WEBCAM

Complete Setup Guide | 设置指南 |  
完整設定指南 | 설치 가이드 |  
Panduan Pemasangan Lengkap

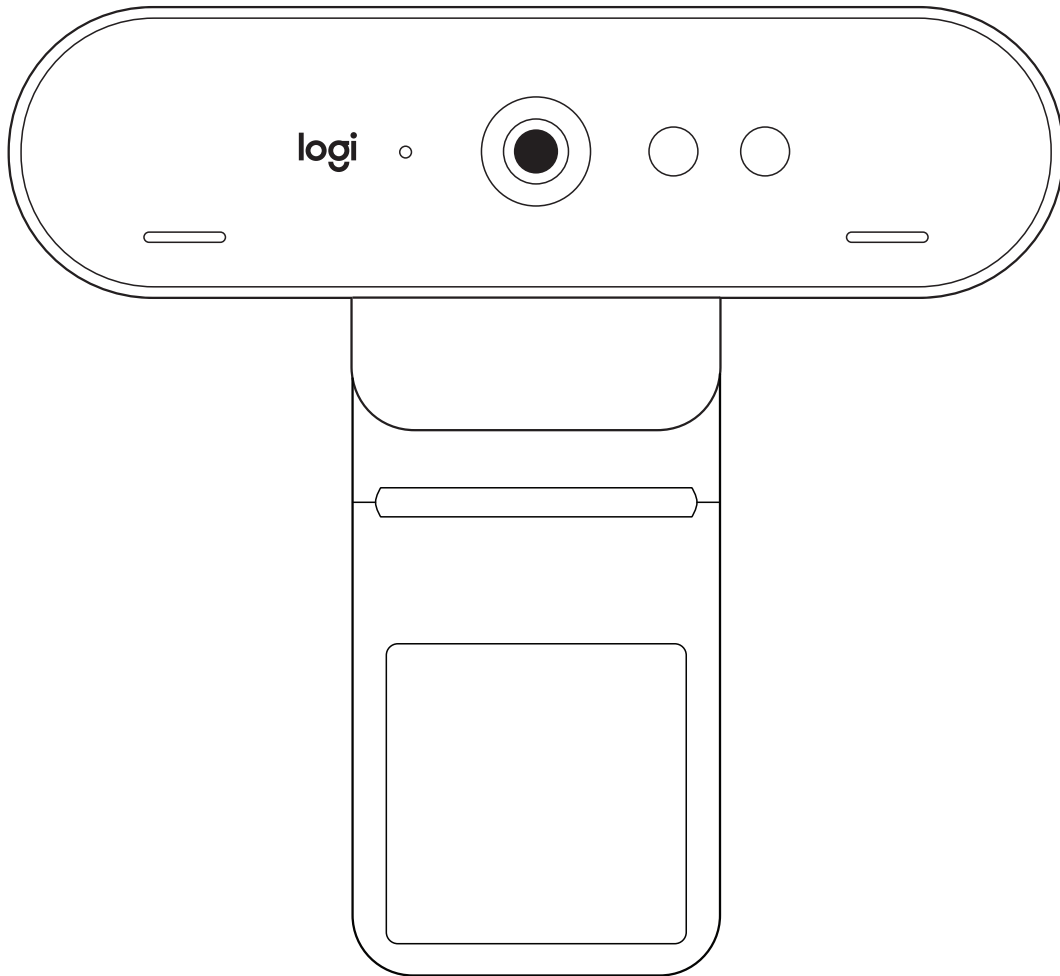

# CONTENTS

English . . . . .3

简体中文 . . . . .9

繁體中文 . . . . . 15

한국어 . . . . . 21

Indonesia . . . . . 27

# KNOW YOUR PRODUCT

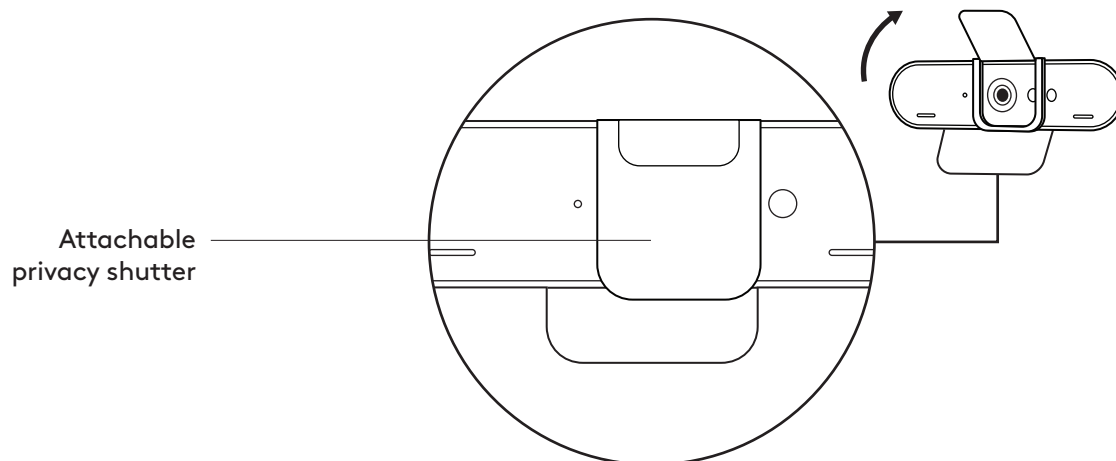
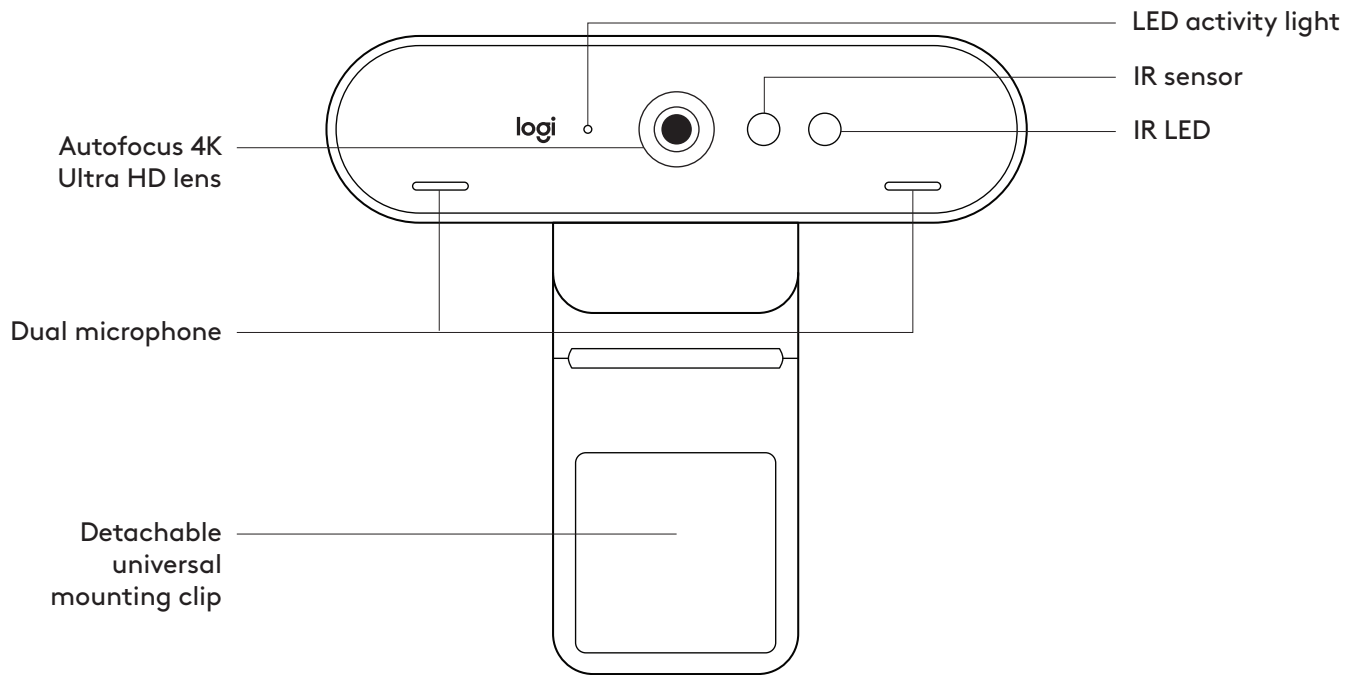

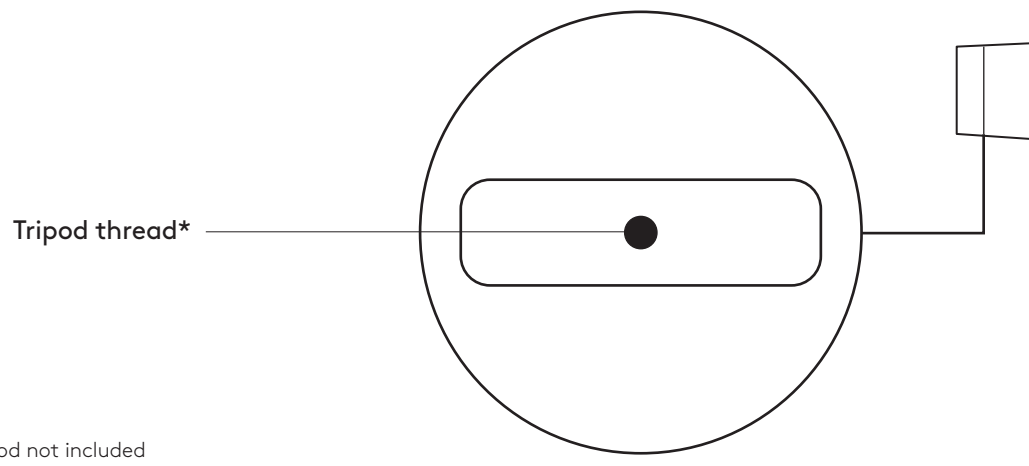

\* Tripod not included

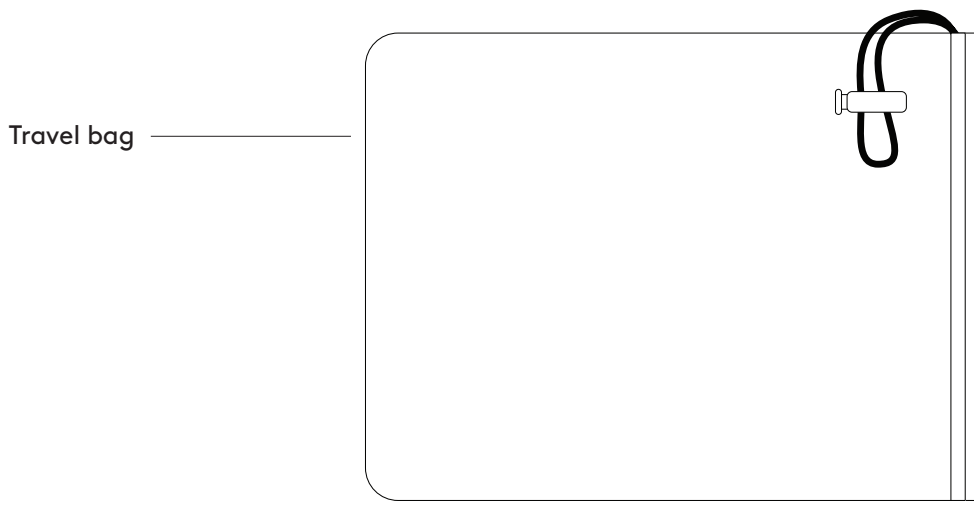
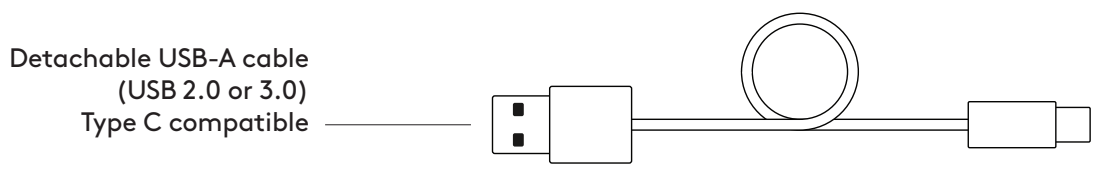

## WHAT'S IN THE BOX

- 1 Webcam with detachable universal mounting clip (on webcam)
- 2 External privacy shutter
- 3 Carrying case
- 4 7.2 ft (2.2 m) USB-A to USB-C cable (USB 2.0 or 3.0)
- 5 User documentation



## ATTACH THE PRIVACY SHUTTER

- 1 Attach the privacy shutter over the lens on the webcam as shown.

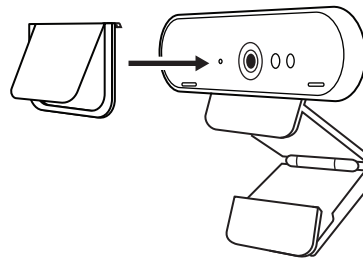

- 2 Snap it onto the front of the webcam, directly over the center.

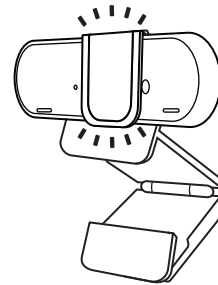

- 3 Manually adjust the privacy shutter to open or close as desired.

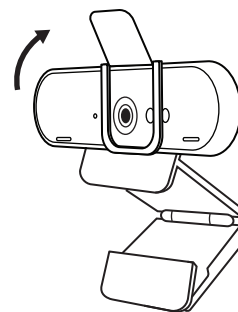

## SETTING UP THE WEBCAM

For placement on a monitor

- 1 Place your webcam on a computer, laptop or monitor at a position or angle you desire.

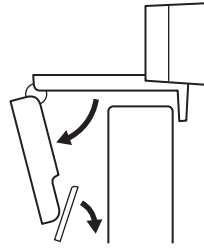

- 2 Adjust the webcam to make sure the foot on the universal mounting clip is flush with the back of your device.

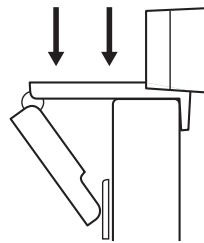

- 3 Manually adjust the webcam up/down to the best position to frame yourself.

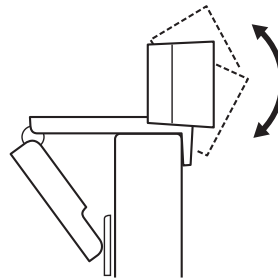

For placement on a tripod\*

- 1 Remove the detachable universal mounting clip from the webcam.

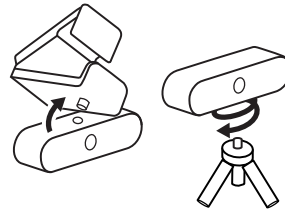

- 2 Locate the 1/4 inch tripod thread on the bottom of the webcam.

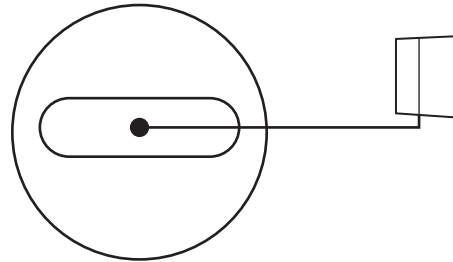

- 3 Secure the webcam on your tripod by twisting it into the 1/4 inch thread.

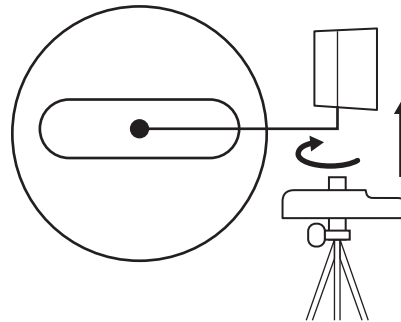

- 4 Place your webcam with the tripod anywhere you desire to the best position to frame yourself.

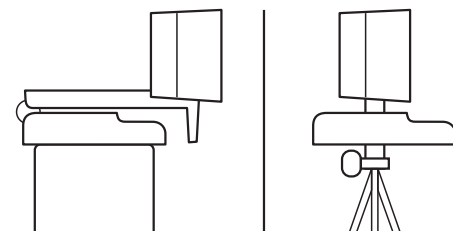

\* Tripod not included

## CONNECTING THE WEBCAM VIA USB-A

Plug the USB-C end into the webcam and the USB-A connector into the USB-A port on your computer.



## SUCCESSFUL CONNECTION

LED activity light will light up when the webcam is in use by an application.

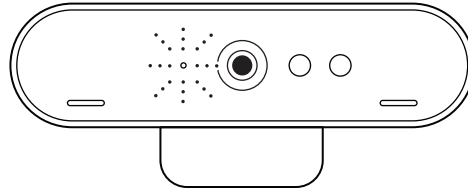

## DIMENSIONS

### WEBCAM:

Height x Width x Depth:  
1.06 in (27 mm) x 4.02 in (102 mm) x 1.04 in (27 mm)

Cable Length: 7.2 ft (2.2 m)

Weight: 2.22 oz (63 g)

### ATTACHABLE MOUNTING CLIP:

Height x Width x Depth:  
0.75 in (19 mm) x 1.42 in (36 mm) x 2.48 in (63 mm)

Weight: 1.55 oz (44 g)

[www.logitech.com/support/brio](http://www.logitech.com/support/brio)



# 了解您的产品

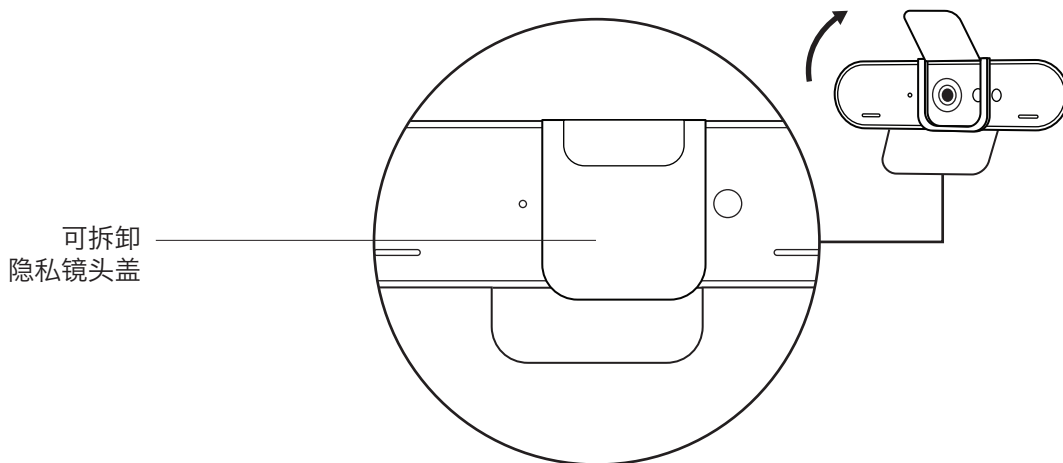
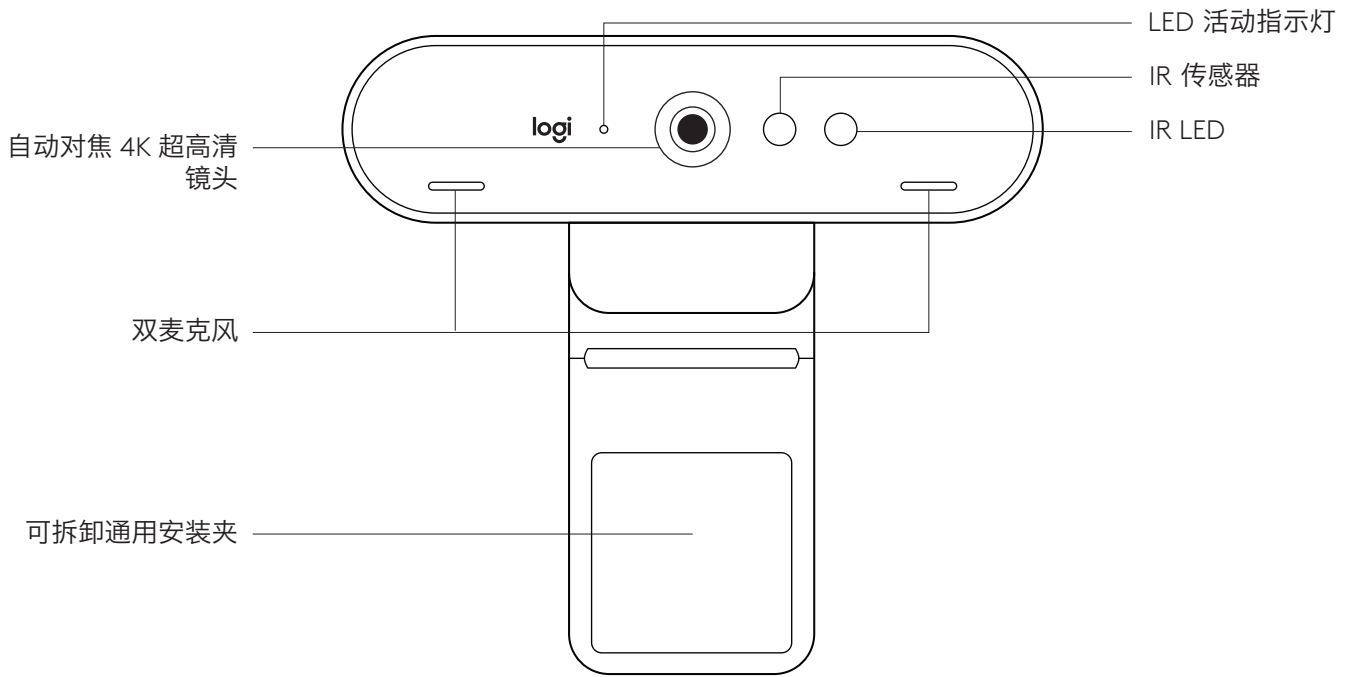

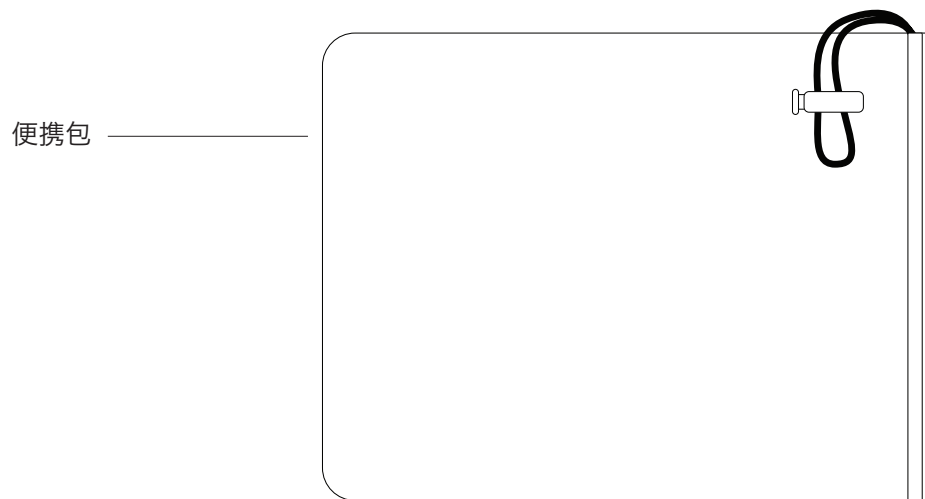
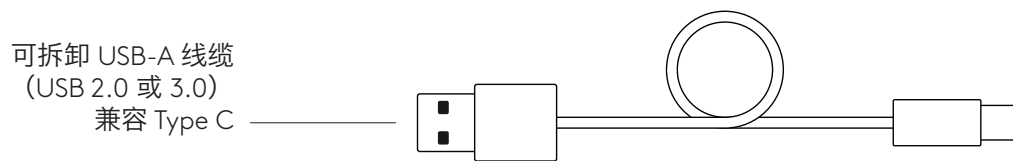
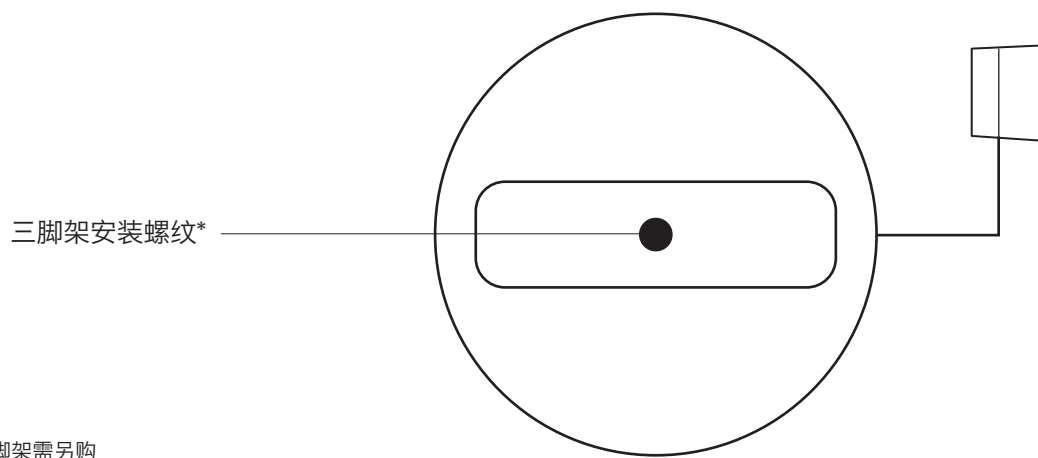

## 包装内容

- 1 网络摄像头，配可拆卸通用安装夹（随附于网络摄像头上）
- 2 外置隐私镜头盖
- 3 收纳盒
- 4 约 2.2 米 USB-A 至 USB-C 线缆（USB 2.0 或 3.0）
- 5 用户文档



## 安装隐私镜头盖

- 1 如下所示，将隐私镜头盖安装于网络摄像头镜头上。

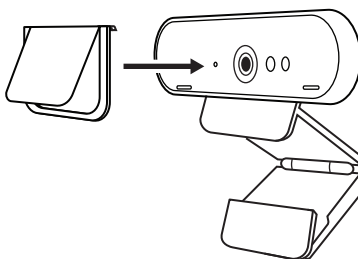

- 2 将其卡在网络摄像头的中央正上方。

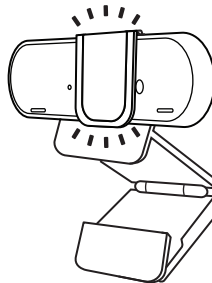

- 3 手动调整隐私镜头盖，根据需要打开或关闭。

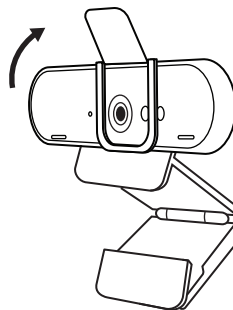

## 设置网络摄像头

放置于显示器上

1 将网络摄像头以所需的位置或角度放置在电脑、笔记本电脑或显示器上。

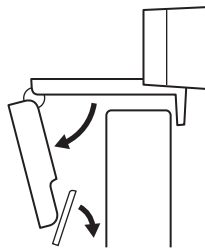

2 调节网络摄像头，确保通用安装夹支脚与显示器背面齐平。

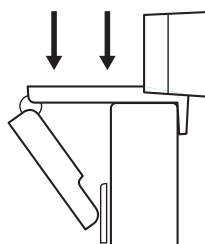

3 手动将网络摄像头上/下调节至合适的构图位置。

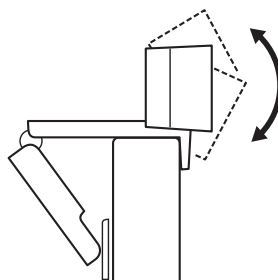

放置于三脚架上\*

1 从网络摄像头上卸下可拆卸的通用安装夹。

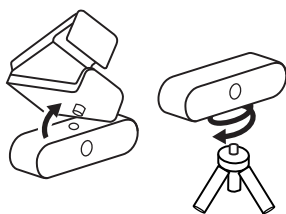

2 找到网络摄像头底部的 1/4 英寸三脚架安装螺纹。

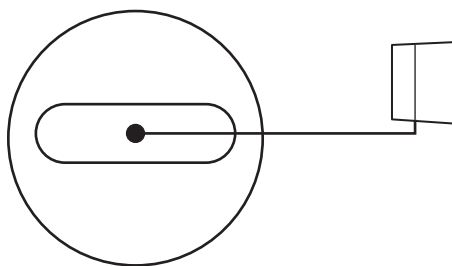

3 将三脚架拧入 1/4 英寸安装螺纹，将网络摄像头固定于三脚架上。

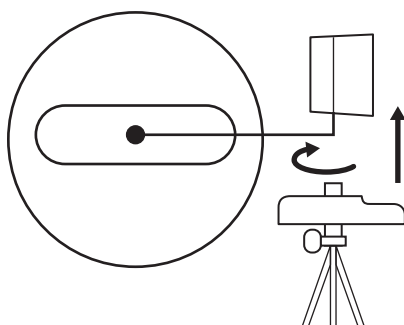

4 将网络摄像头和三脚架放置于您想要的合适位置以构图。

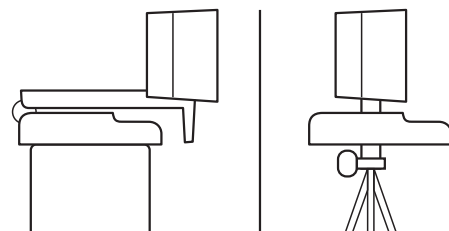

\*三脚架需另购

## 通过 USB-A 连接网络摄像头

将 USB-C 端插入网络摄像头，并将 USB-A 接头插入电脑的 USB-A 端口。

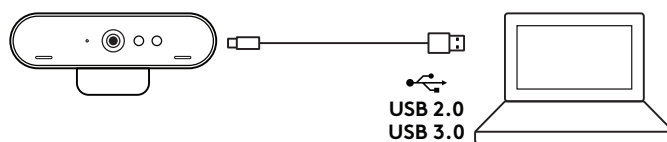

## 成功连接

当应用程序使用网络摄像头时，LED 活动指示灯将点亮。

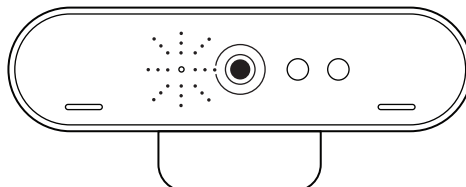

## 规格

### 网络摄像头:

高 x 宽 x 深:

约 27 毫米 x 约 102 毫米 x 约 27 毫米

线缆长度: 约 2.2 米

重量: 约 63 克

### 可拆卸通用安装夹:

高 x 宽 x 深:

约 19 毫米 x 约 36 毫米 x 约 63 毫米

重量: 约 44 克

[www.logitech.com/support/brio](http://www.logitech.com/support/brio)

# 瞭解您的產品

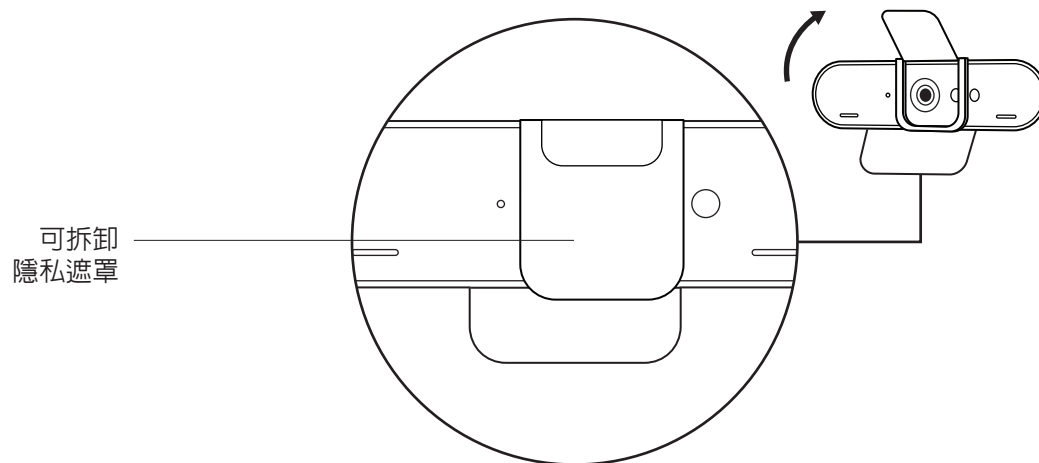
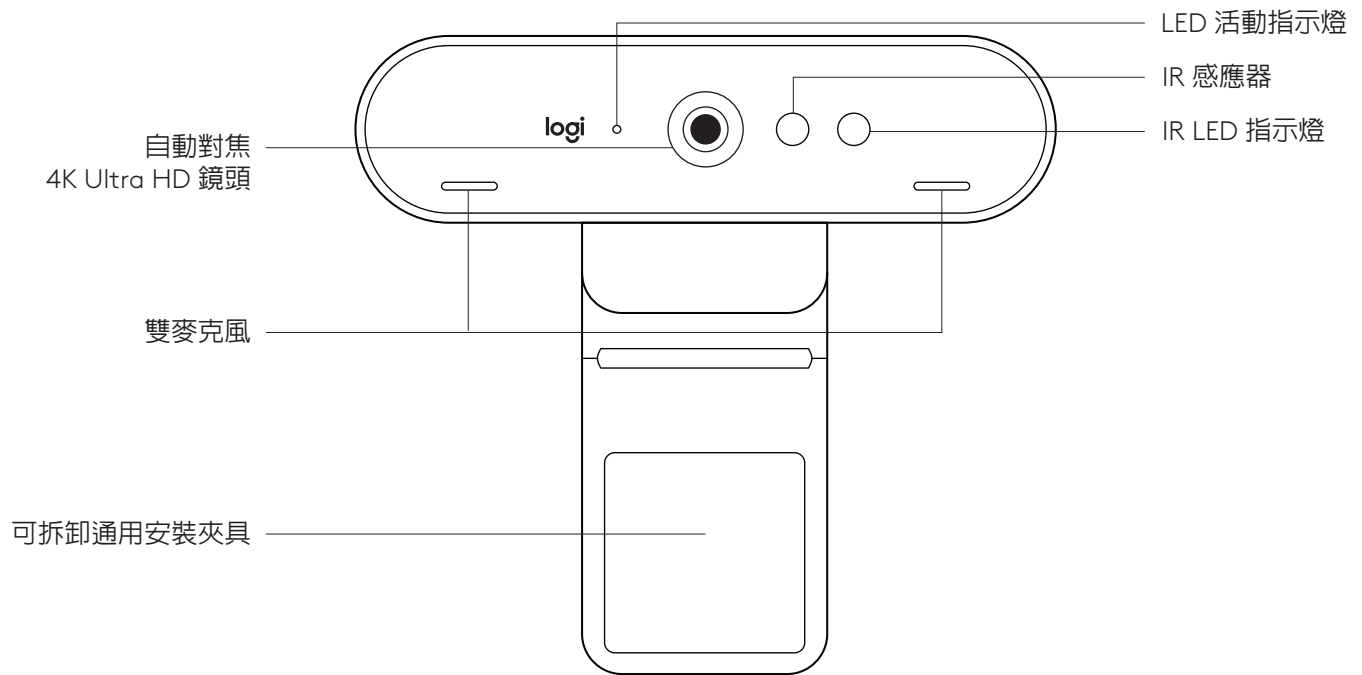

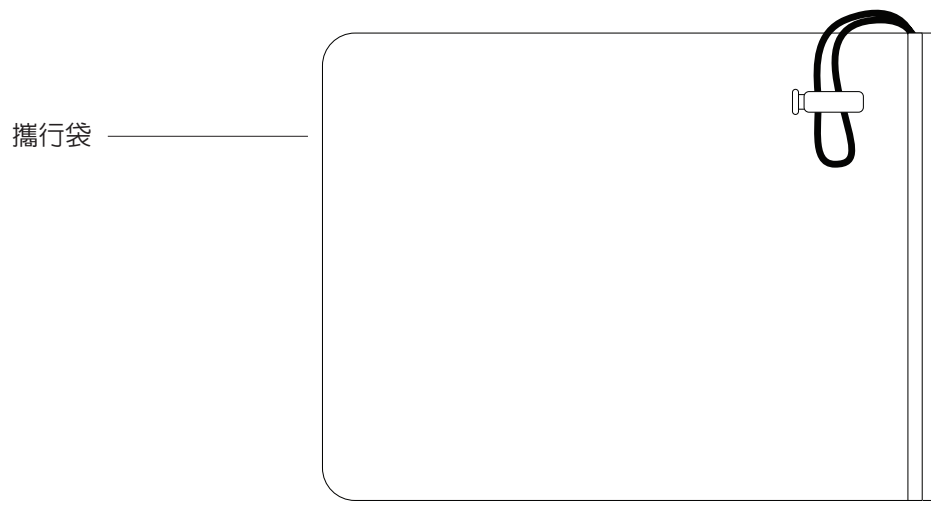
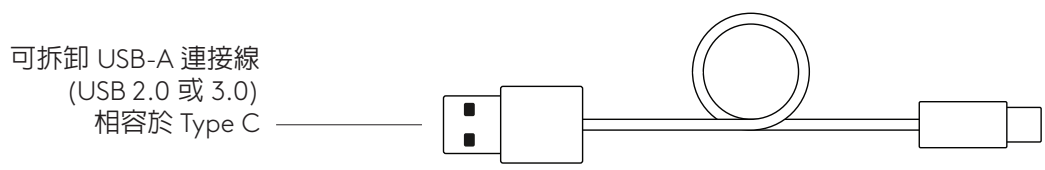
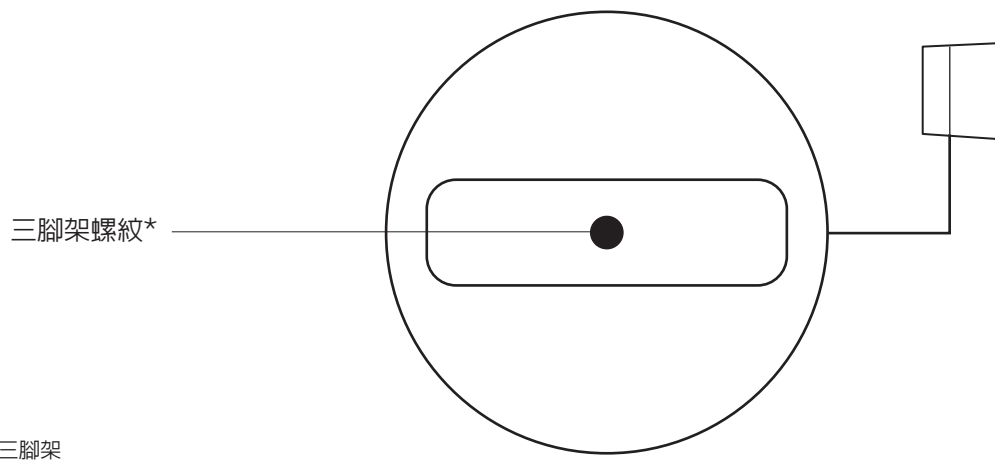



## 包裝內容

- 1 機身具有可拆卸通用安裝夾具的網路攝影機
- 2 外接隱私遮罩
- 3 攜帶盒
- 4 2.2 公尺 (7.2 英呎) USB-A 轉 USB-C 連接線 (USB 2.0 或 3.0)
- 5 使用者文件



## 裝上隱私遮罩

- 1 在攝影機鏡頭上裝上隱私遮罩，如圖所示。

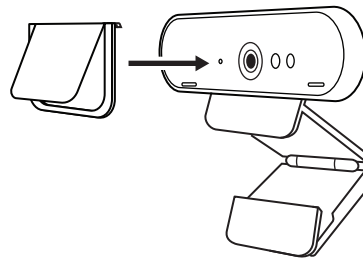

- 2 將其裝在網路攝影機前方正中間上方的位置。

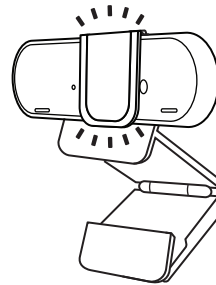

- 3 在需要時手動調整隱私遮罩開啓或關閉。

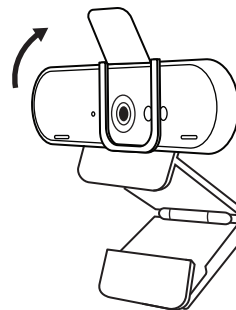

## 設定網路攝影機

放在螢幕上

- 1 將網路攝影機放到電腦、筆記型電腦或顯示器上您要的位置或角度。

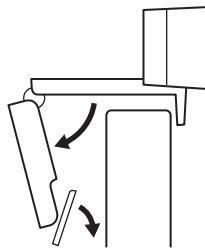

- 2 調整網路攝影機，確認通用安裝夾的腳架與您的裝置背面齊平。

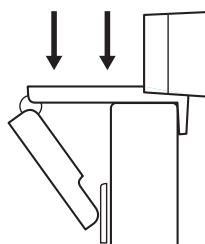

- 3 手動上/下調整網路攝影機，將其調整到對準您取景的最佳位置。

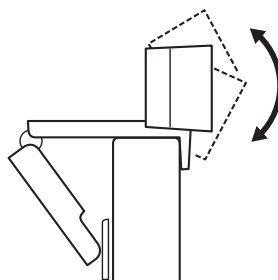

放在三腳架上\*

1 從網路攝影機上取下可拆卸通用安裝夾具。

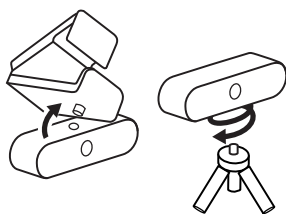

2 找到位於網路攝影機底部的 1/4 英寸三腳架安裝螺紋。

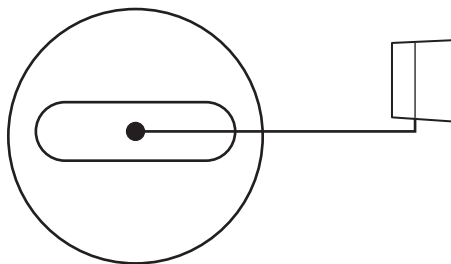

3 將三腳架轉入 1/4 英寸螺紋中，使網路攝影機固定在三腳架上。

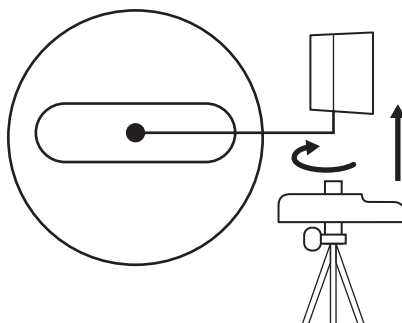

4 將網路攝影機連同三腳架放在您想要的、能夠獲得最佳自拍角度的任何位置。

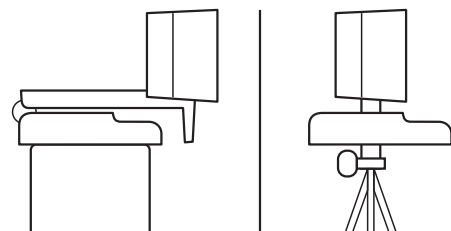

\* 未隨附三腳架

### 透過 USB-A 連接網路攝影機

將 USB-C 端插入網路攝影機，並將 USB-A 接頭插入您電腦的 USB-A 連接埠。



### 成功連接

LED 活動指示燈會在應用程式使用網路攝影機時亮起。

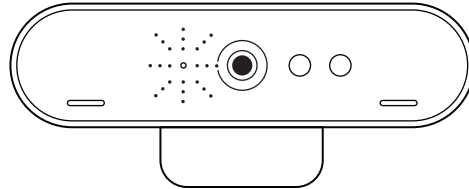

## 尺寸

### 網路攝影機：

高 x 寬 x 深：  
27 公釐 (1.06 英吋) x 102 公釐 (4.02 英吋) x 27 公釐 (1.04 英吋)  
連接線長度：2.2 公尺 (7.2 英呎)  
重量：63 公克 (2.22 盎司)

### 可拆卸安裝夾具：

高 x 寬 x 深：  
19 公釐 (0.75 英吋) x 36 公釐 (1.42 英吋) x 63 公釐 (2.48 英吋)  
重量：44 公克 (1.55 盎司)

[www.logitech.com/support/brio](http://www.logitech.com/support/brio)

# 제품 설명

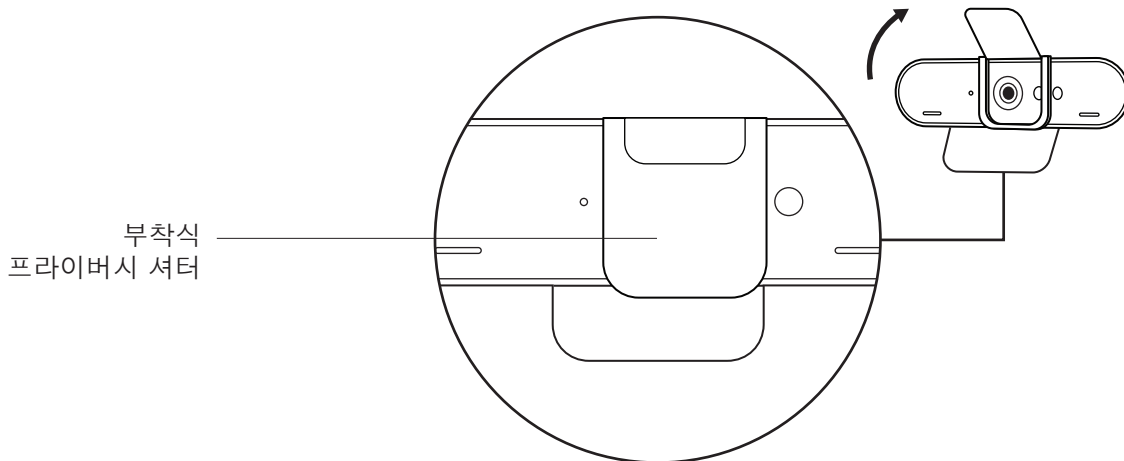
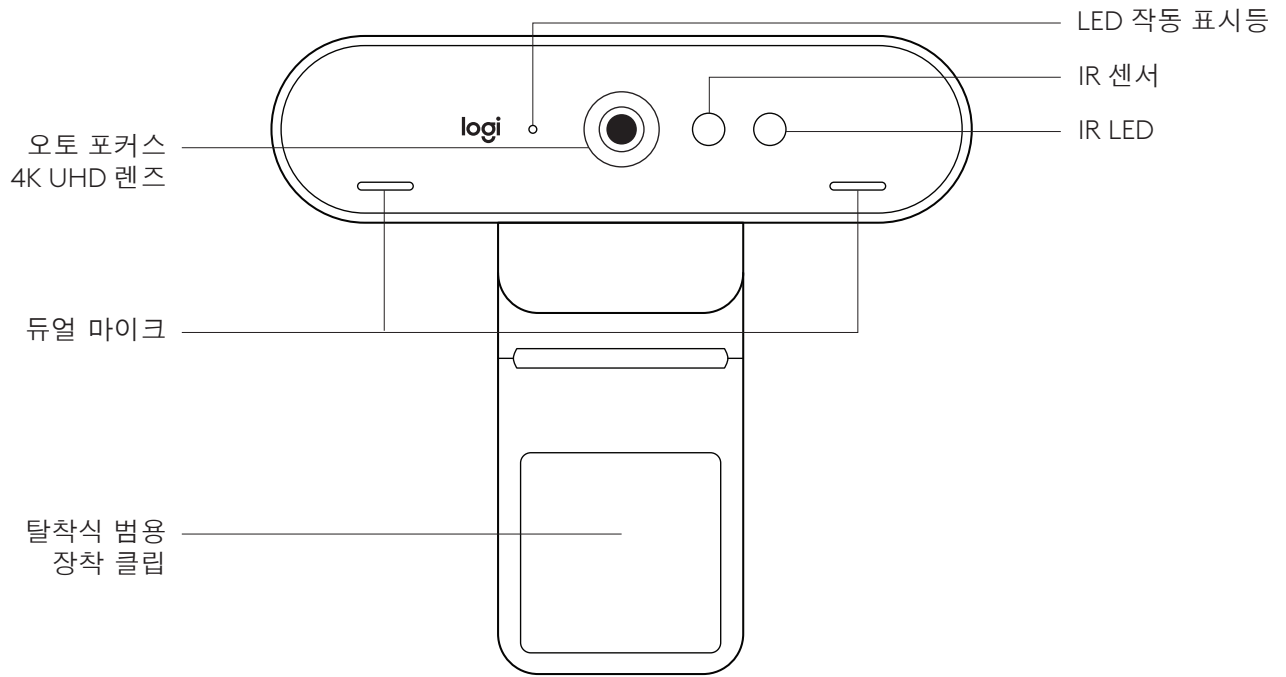

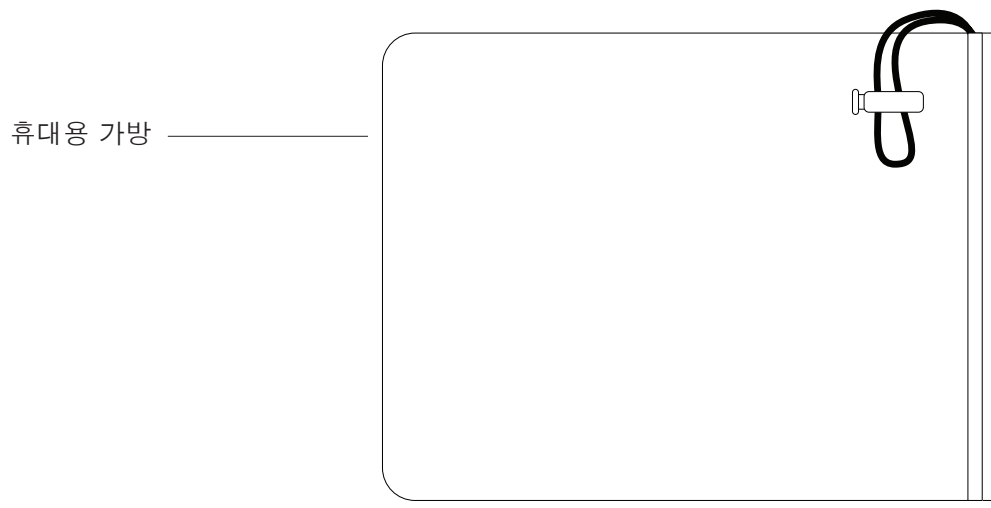
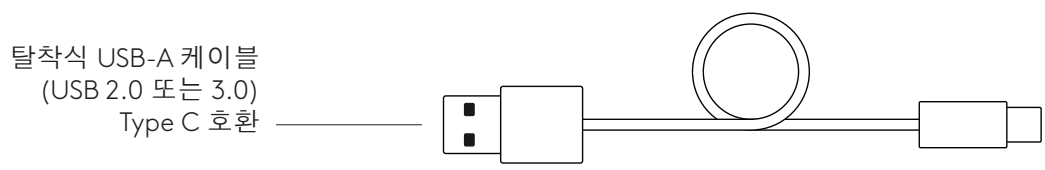
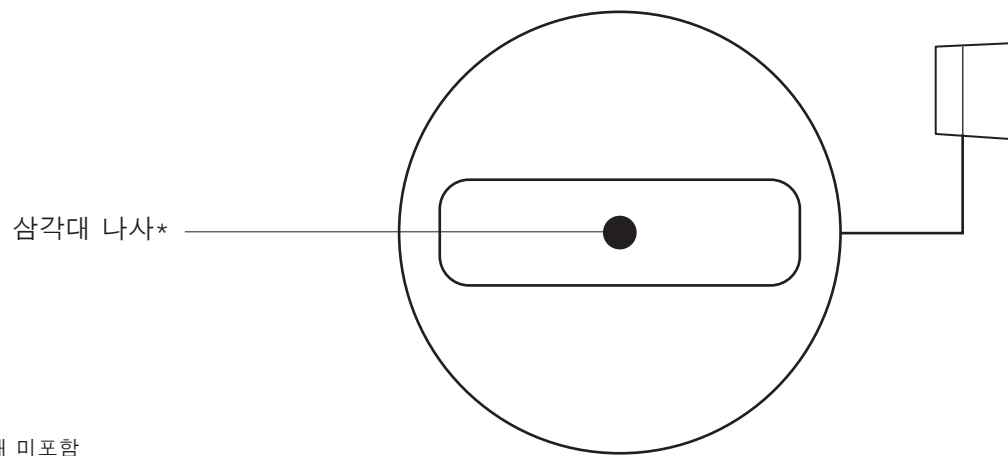

## 박스 내용물

- 1 탈착식 범용 장착 클립이 달린 웹캠 (웹캠에 부착)
- 2 외부 프라이버시 셔터
- 3 휴대용 케이스
- 4 2.2m(7.2피트) USB-A to USB-C 케이블 (USB 2.0 또는 3.0)
- 5 사용 설명서



## 프라이버시 셔터 장착

- 1 그림과 같이 렌즈 위에 프라이버시 셔터를 장착합니다.

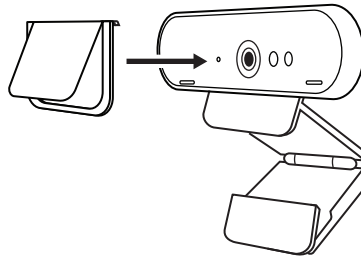

- 2 웹캠의 전면, 중앙 위에 끼웁니다.

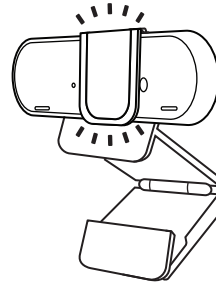

- 3 프라이버시 셔터를 수동으로 조절하여 원하는 대로 여닫습니다.

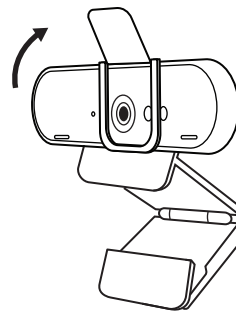

## 웹캠 설정

모니터에 배치할 경우

- 1 컴퓨터 위, 노트북, 모니터 등 원하는 위치 및 각도에 웹캠을 거치합니다.

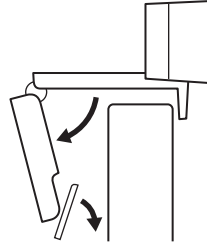

- 2 웹캠을 조절하여 거치할 장치의 후면과 범용 장착 클립의 발이 평행을 이루게 합니다.

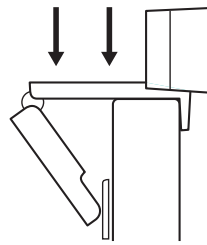

- 3 웹캠을 위아래로 조절하여 최적의 촬영 위치를 찾습니다.

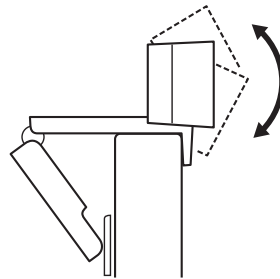



삼각대에 배치할 경우\*

1 웹캠에서 탈착식 범용 장착 클립을 제거합니다.

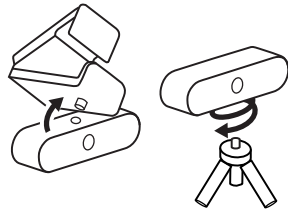

2 웹캠 하단에서 1/4인치 삼각대 나사를 찾습니다.

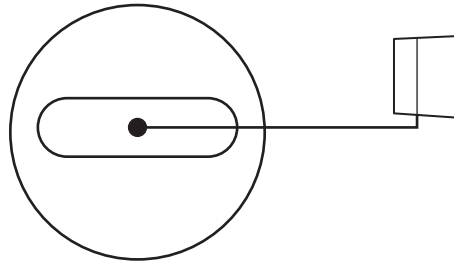

3 웹캠을 1/4인치 나사에 끼워 삼각대에 고정합니다.

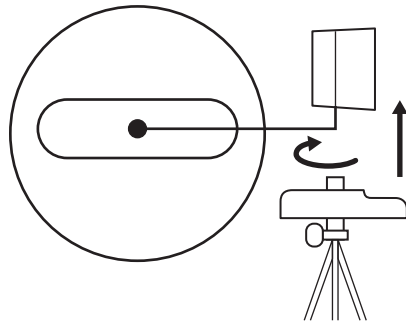

4 삼각대에 장착된 웹캠을 배치하여 최적의 촬영 위치를 찾습니다.

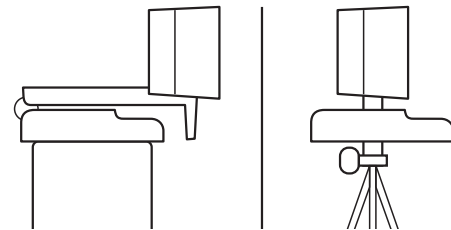

\* 삼각대 미포함

## USB-A로 웹캠 연결

USB-C의 끝을 웹캠에 연결하고 USB-A 커넥터를 컴퓨터 USB-A 포트에 연결합니다.



## 연결 성공

애플리케이션에서 웹캠을 사용하면 LED 작동 표시등에 불이 들어옵니다.

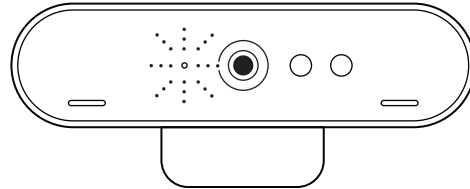

## 규격

### 웹캠:

높이 x 너비 x 높이:  
27mm(1.06인치)x102mm(4.02인치)x27mm(1.04인치)  
케이블 길이: 2.2m(7.2피트)  
무게: 63g(2.22oz)

### 부착식 장착 클립:

높이 x 너비 x 높이:  
19mm(0.75인치)x36mm(1.42인치)x63mm(2.48인치)  
무게: 44g(1.55oz)

[www.logitech.com/support/brio](http://www.logitech.com/support/brio)

## MENGENAL PRODUK

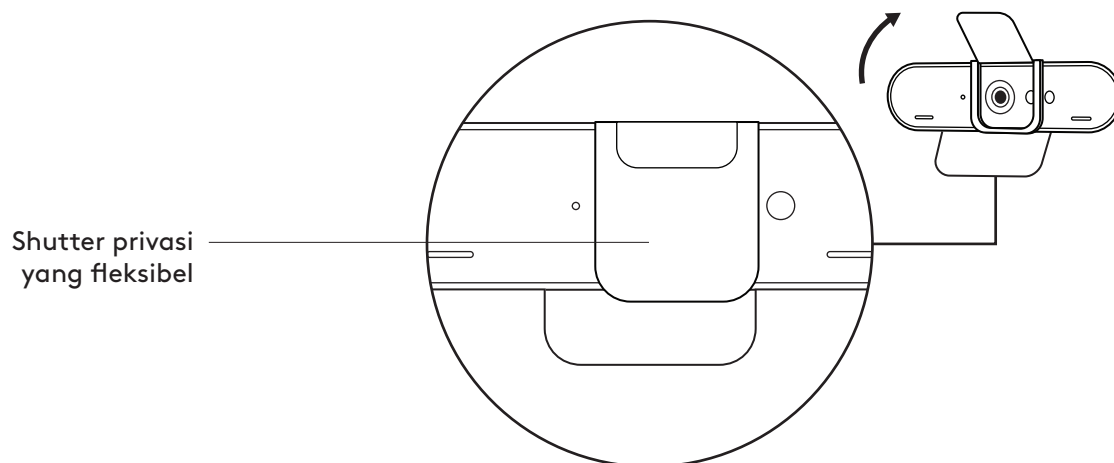
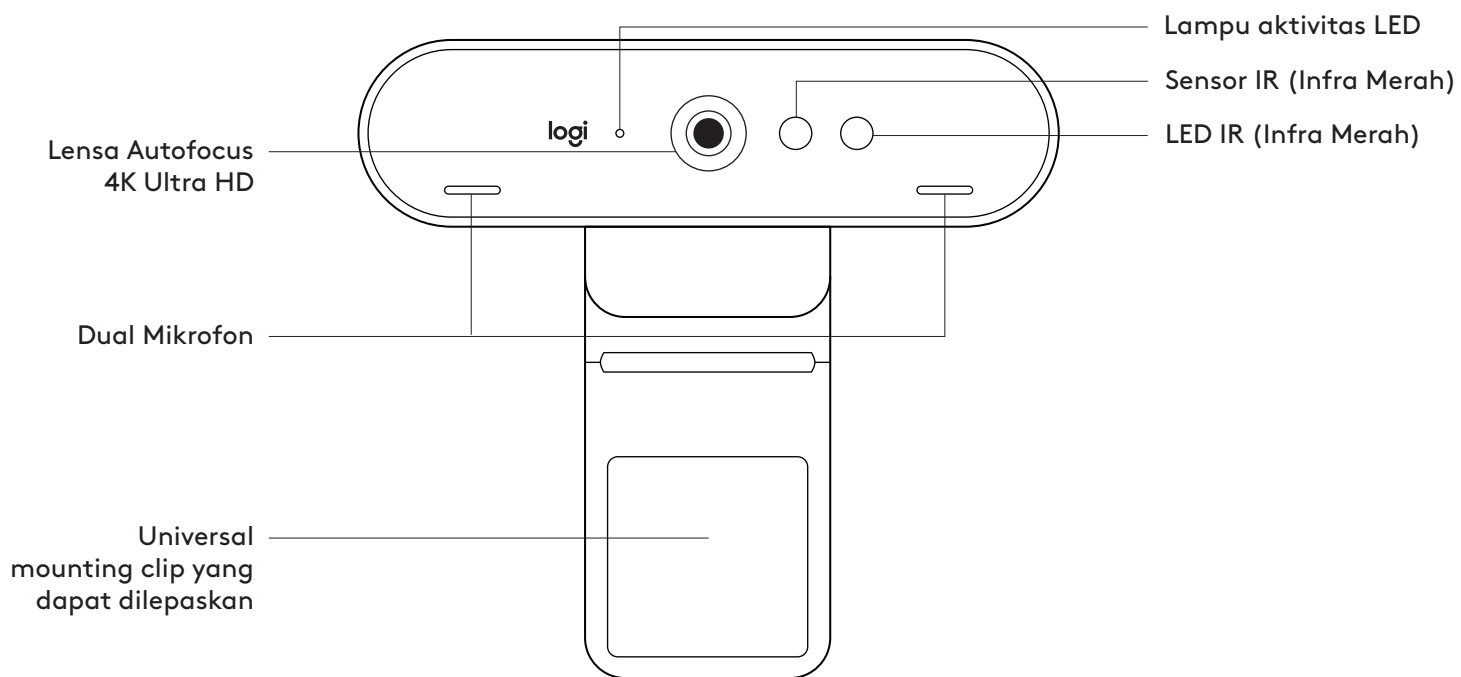

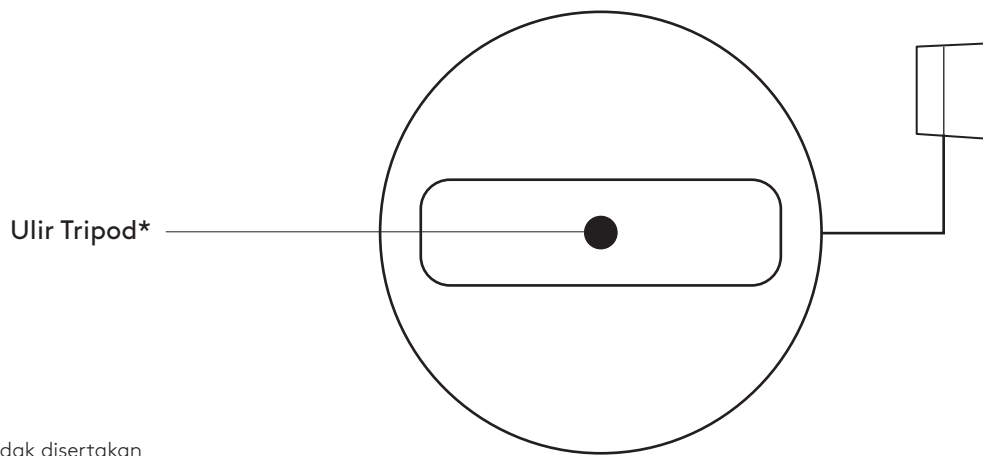

\* Tripod tidak disertakan

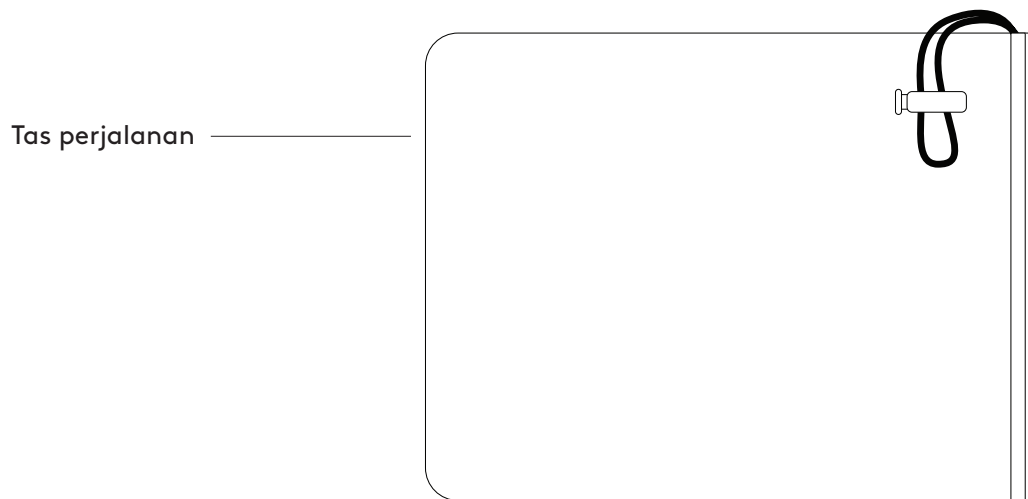
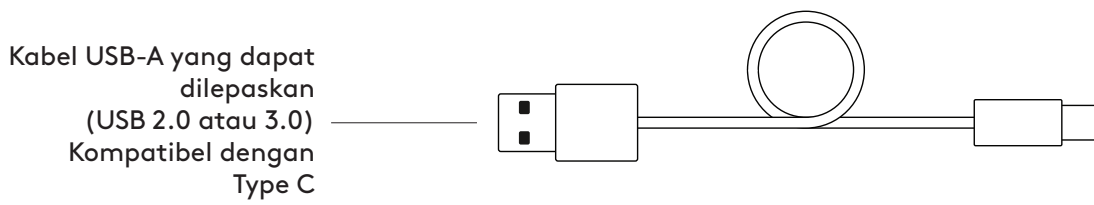

## ISI KEMASAN

- 1 Webcam dengan universal mounting clip yang dapat dilepaskan (pada webcam)
- 2 Shutter privasi eksternal
- 3 Tas webcam
- 4 Kabel USB-A ke USB-C (USB.2.0 atau 3.0) 7,2 kaki (2,2 m)
- 5 Dokumentasi pengguna



## MEMASANG SHUTTER PRIVASI

- 1 Pasangkan shutter privasi di depan lensa pada webcam seperti yang ditunjukkan.

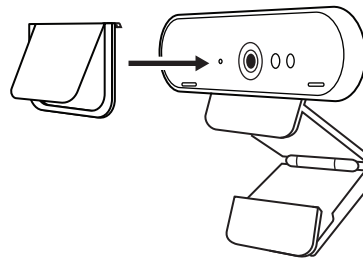

- 2 Pasangkan di bagian depan webcam, tepat di tengah-tengah.

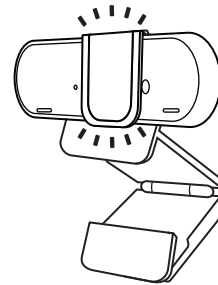

- 3 Secara manual sesuaikan shutter privasi untuk membuka atau menutup sesuai yang diinginkan.

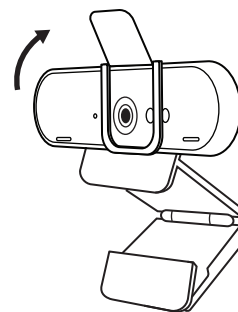

## MEMASANG WEBCAM

Untuk penempatan di atas layar

- 1 Letakkan webcam Anda di komputer, laptop, atau layar pada posisi atau sudut yang Anda inginkan.

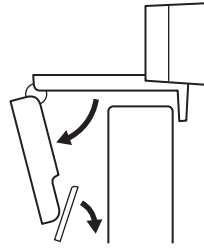

- 2 Sesuaikan webcam untuk memastikan kaki universal mounting clip terpasang erat dengan bagian belakang perangkat Anda.

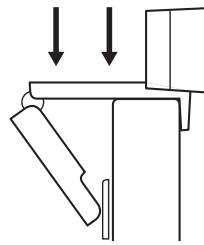

- 3 Gerakkan webcam ke atas/ke bawah ke posisi terbaik agar bisa menangkap diri Anda.

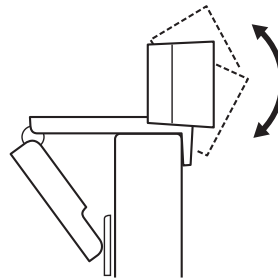

Untuk penempatan di atas tripod\*

- 1 Lepaskan universal mounting clip yang dapat dilepaskan dari webcam

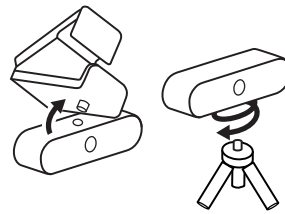

- 2 Cari ulir tripod 1/4 inci di bagian bawah webcam.

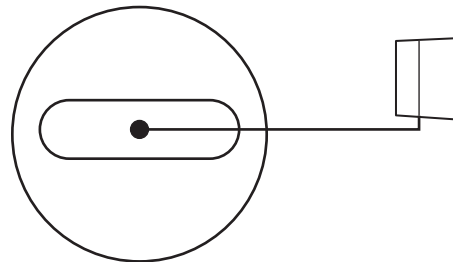

- 3 Pasangkan webcam di tripod Anda dengan memutarinya pada ulir 1/4 inci.

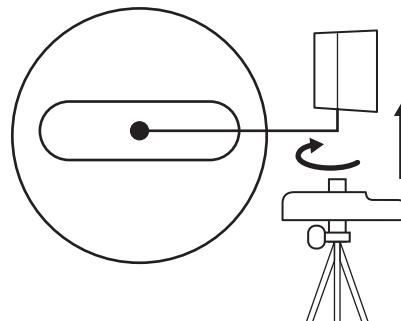

- 4 Letakkan webcam yang telah terpasang di tripod di mana pun yang Anda inginkan agar mendapatkan posisi terbaik untuk menyorot diri Anda.

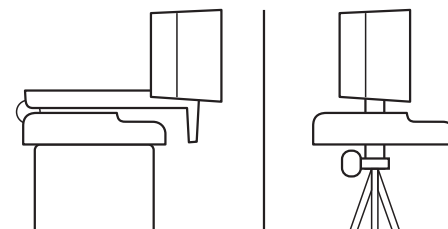

\* Tripod tidak disertakan

## MENGHUBUNGKAN WEBCAM VIA USB-A

Pasangkan ujung USB-C ke webcam dan konektor USB-A ke port USB-A di komputer Anda.



## KONEKSI BERHASIL

Lampu aktivitas LED akan menyala ketika webcam digunakan oleh sebuah aplikasi.

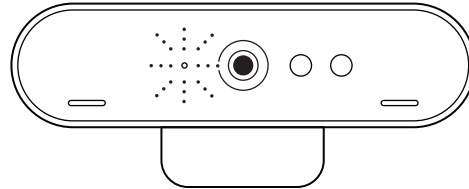

## DIMENSI

### WEBCAM:

Tinggi x Lebar x Tebal:

1,06 inci (27 mm) x 4,02 inci (102 mm) x 1,04 inci (27 mm)

Panjang Kabel: 7,2 kaki (2,2 m)

Berat: 2,22 oz (63 g)

### MOUNTING CLIP YANG FLEKSIBEL:

Tinggi x Lebar x Tebal:

0,75 inci (19 mm) x 1,42 inci (36 mm) x 2,48 inci (63 mm)

Berat: 1,55 oz (44 g)

[www.logitech.com/support/brio](http://www.logitech.com/support/brio)