

C920c HD WEBCAM

C920c 高清网络摄像头

Complete Setup Guide
设置指南

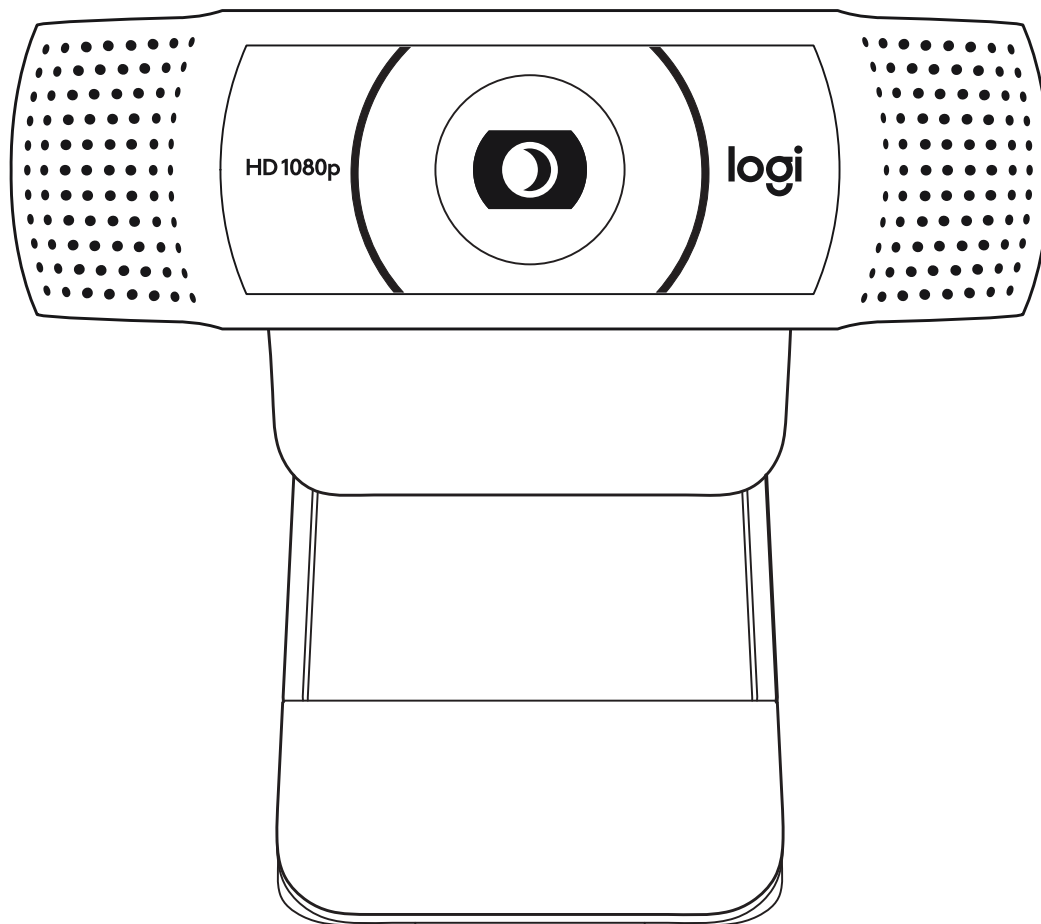

logitech 罗技®

CONTENTS

English3

简体中文7

KNOW YOUR PRODUCT

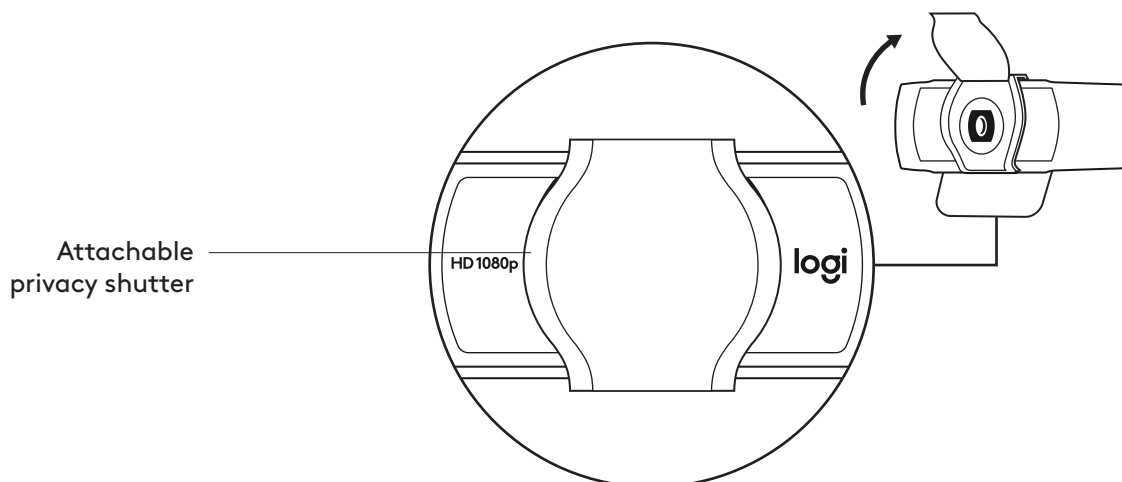
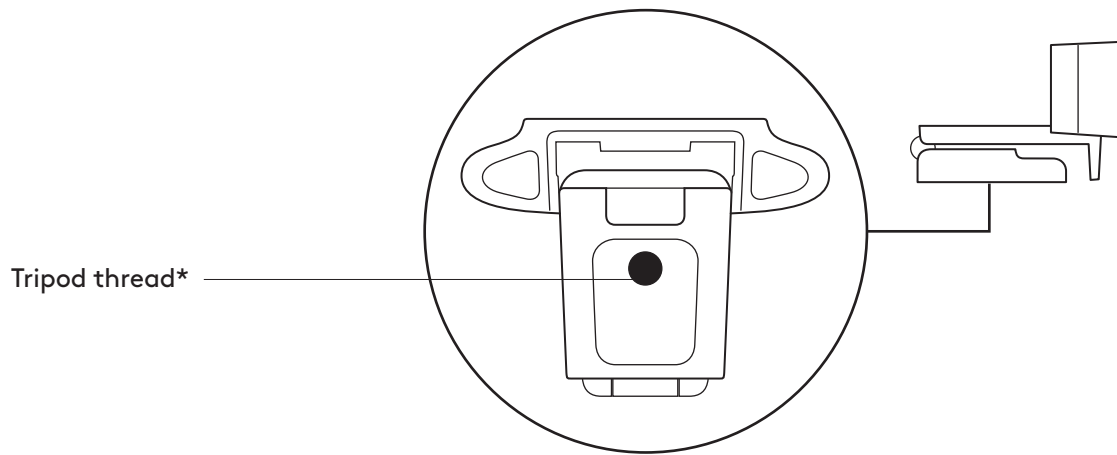
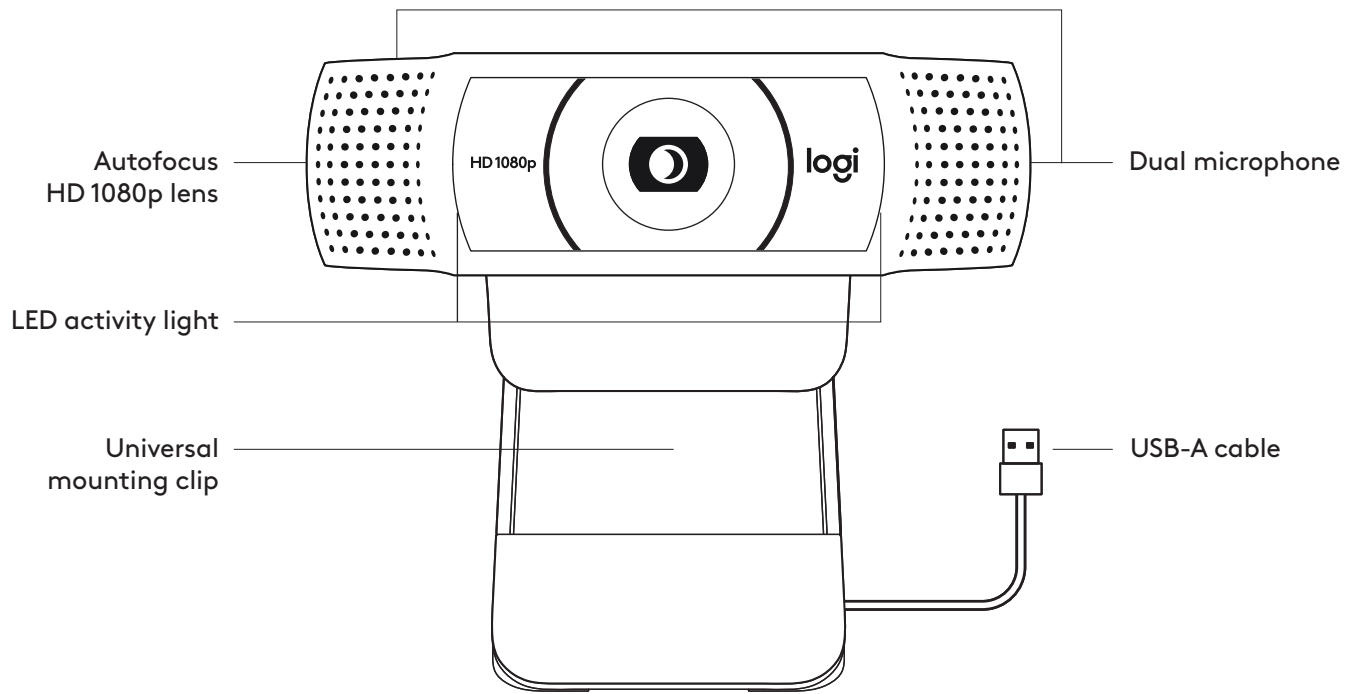

* Tripod not included

WHAT'S IN THE BOX

- 1 Webcam with 5 ft (1.5 m) attached USB-A cable
- 2 Privacy shutter
- 3 User documentation

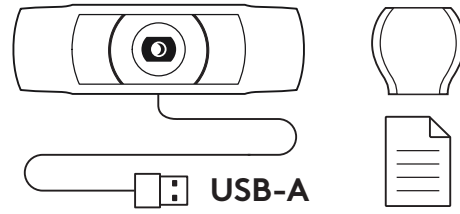

ATTACH THE PRIVACY SHUTTER

- 1 Attach external privacy shutter by locating the lens on the webcam.

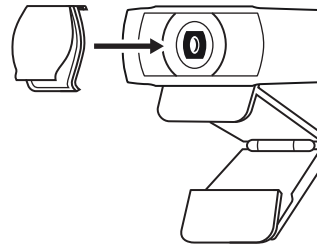

- 2 Snap it onto the front of the webcam, directly over the center.

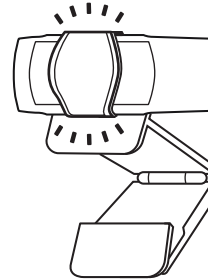

- 3 Manually adjust the privacy shutter to open or close as desired.

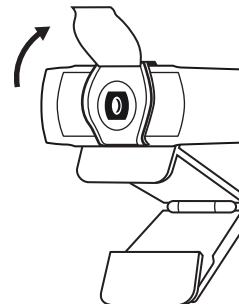

SETTING UP THE WEBCAM

For placement on a monitor

- 1 Place your webcam on a computer, laptop or monitor at a position or angle you desire.

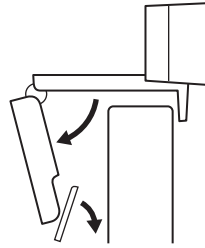

- 2 Adjust the webcam to make sure the foot on the universal mounting clip is flush with the back of your device.

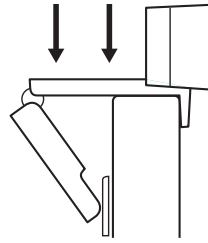

- 3 Manually adjust the webcam up/down to the best position to frame yourself.

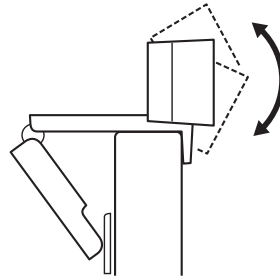

For placement on a tripod*

- 1 Locate the 1/4 inch tripod thread on the bottom of the universal mounting clip.

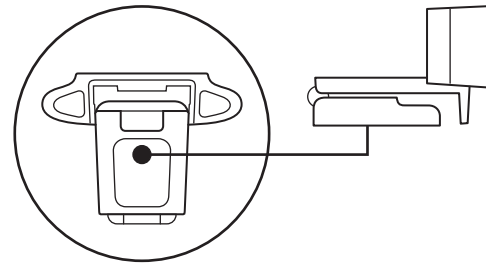

- 2 Secure the webcam on your tripod by twisting it into the 1/4 inch thread.

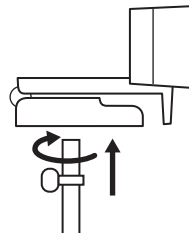

- 3 Place your webcam with the tripod in the best position to frame yourself.

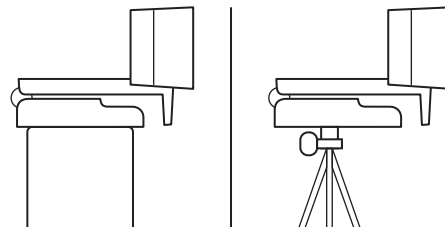

* Tripod not included

CONNECTING THE WEBCAM VIA USB-A

Plug the USB-A connector into the USB-A port on your computer.

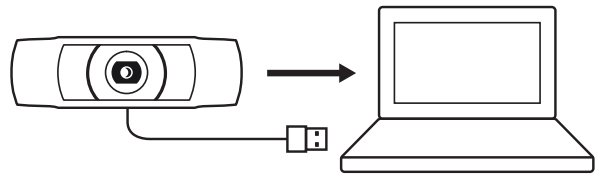

SUCCESSFUL CONNECTION

LED activity light will light up when the webcam is in use by an application.

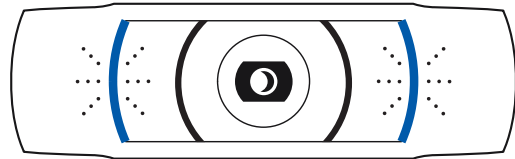

DIMENSIONS

INCLUDING FIXED MOUNTING CLIP:

Height x Width x Depth:

1.70 in (43.3 mm) x 3.70 in (94 mm) x 2.80 in (71 mm)

Cable Length: 5 ft (1.5 m)

Weight: 5.71 oz (162 g)

www.logitech.com/support/C920e

了解您的产品

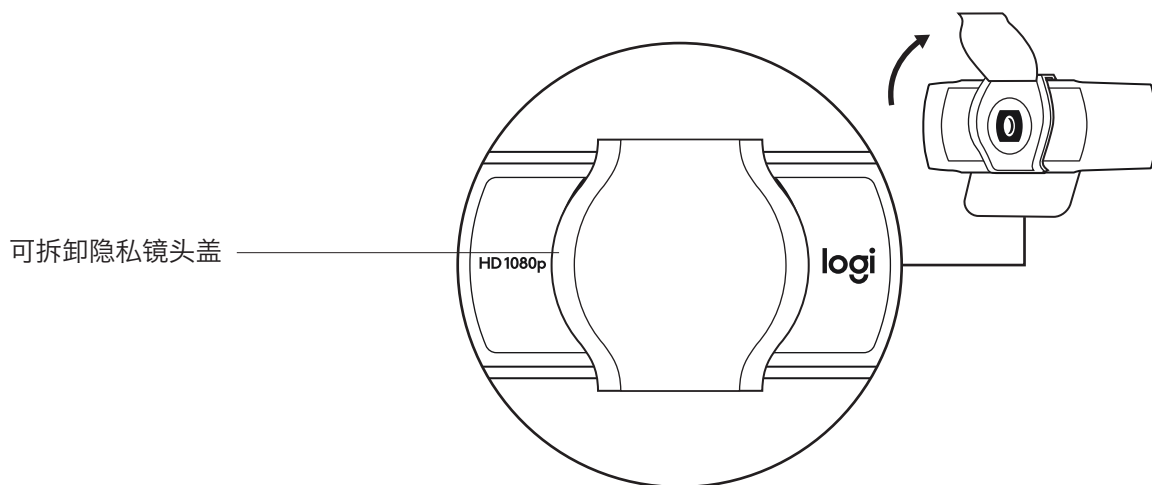
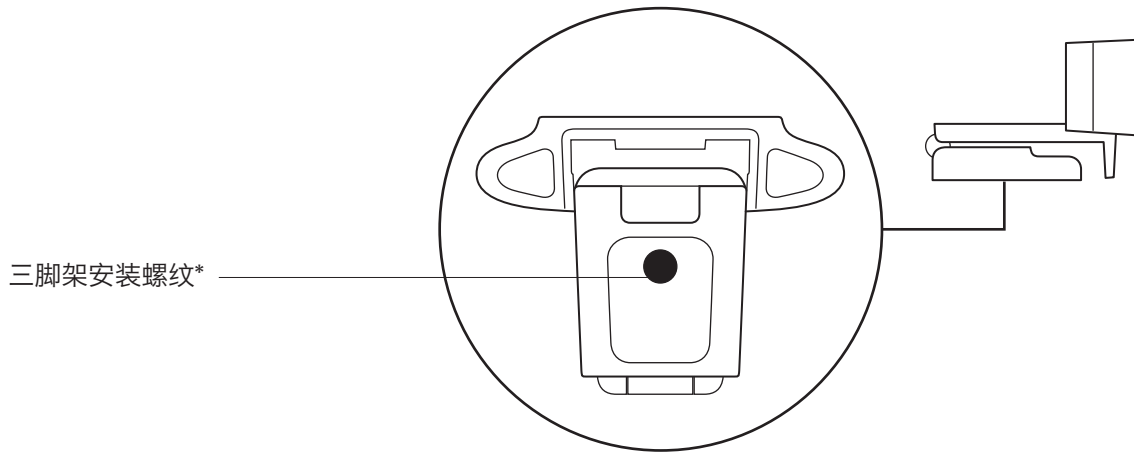
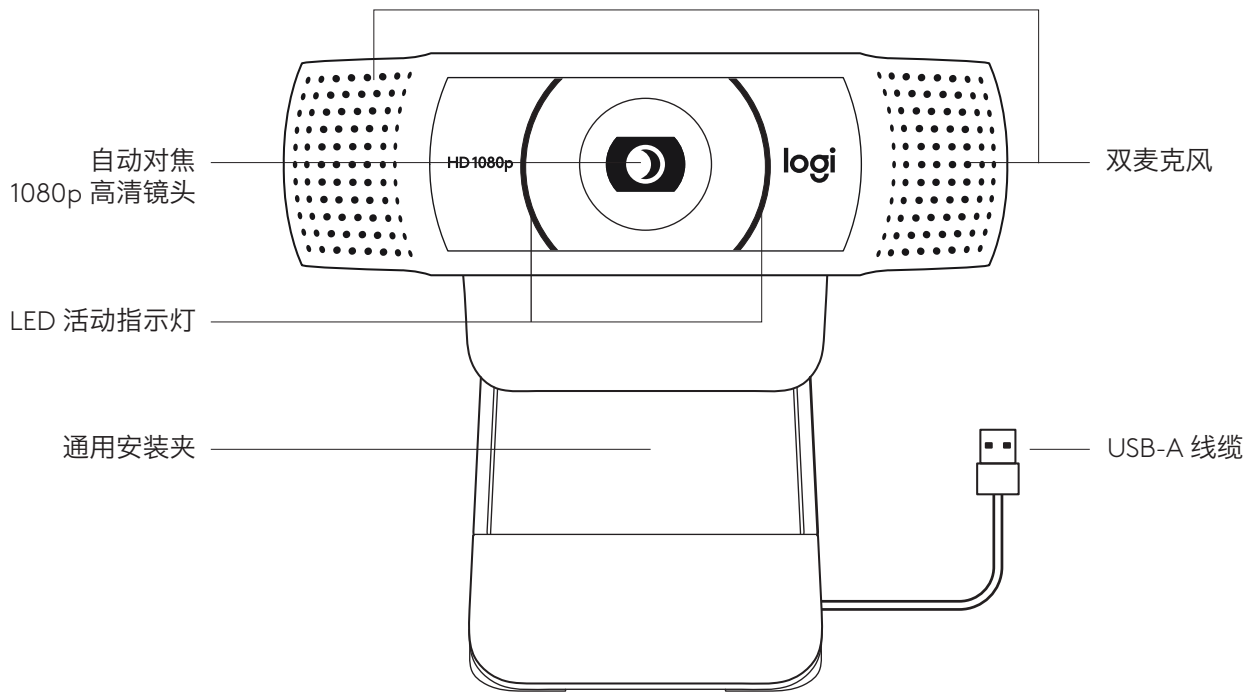

* 三脚架需另购

包装内容

- 1 网络摄像头，附约 1.5 米 USB-A 线缆
- 2 隐私镜头盖
- 3 用户文档

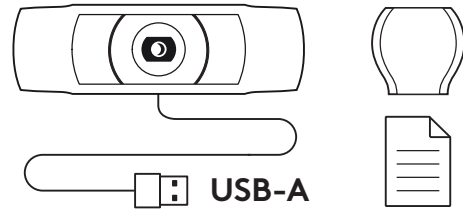

安装隐私镜头盖

- 1 将外置隐私镜头盖安装于网络摄像头镜头上。

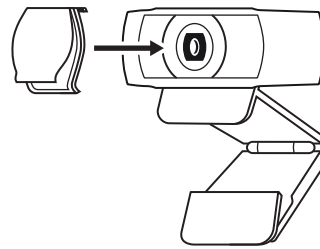

- 2 将其卡在网络摄像头的中央正上方。

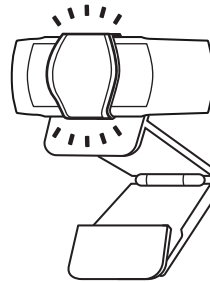

- 3 手动调整隐私镜头盖，根据需要打开或关闭。

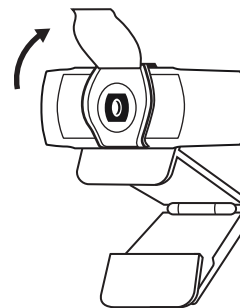

设置网络摄像头

放置于显示器上

1 将网络摄像头以所需的位置或角度放置在电脑、笔记本电脑或显示器上。

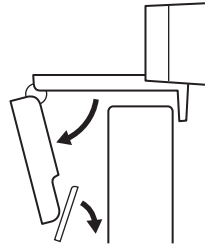

2 调节网络摄像头，确保通用安装夹支脚与显示器背面齐平。

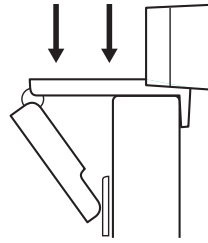

3 手动将网络摄像头上/下调节至合适的构图位置。

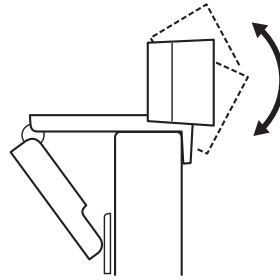

放置于三脚架上*

1 找到通用安装夹底部的 1/4 英寸三脚架安装螺纹。

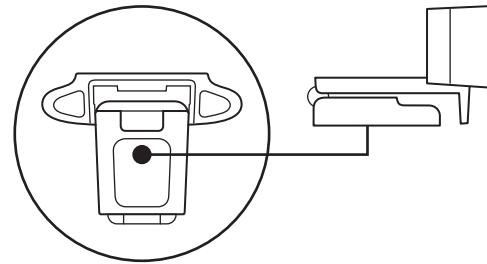

2 将三脚架拧入 1/4 英寸安装螺纹，将网络摄像头固定于三脚架上。

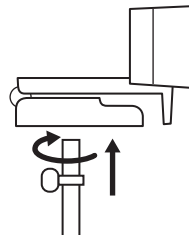

3 将网络摄像头和三脚架放置于合适的构图位置。

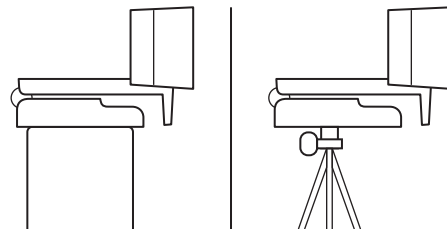

* 三脚架需另购

通过 USB-A 连接网络摄像头

将 USB-A 接头插入电脑的 USB-A 端口。

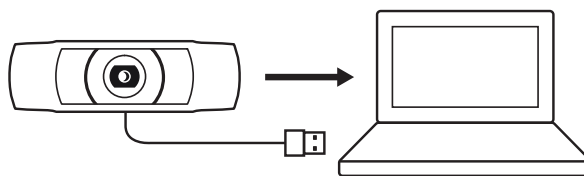

成功连接

当应用程序使用网络摄像头时，LED 活动指示灯将点亮。

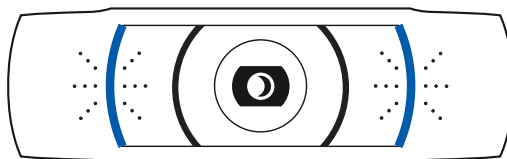

规格

包括固定的安装夹：

高 x 宽 x 深：

约43.3 毫米 x 约94 毫米 x 约71 毫米

线缆长度：约1.5 米

重量：约162 克

www.logitech.com/support/C920c