

LOGITECH ZONE 900 REPLACEABLE EARPAD COVERS

罗技 ZONE 900 可替换耳垫

Complete Setup Guide | 设置指南 |
完整設定指南 | 설치 가이드 |
Panduan Pemasangan Lengkap

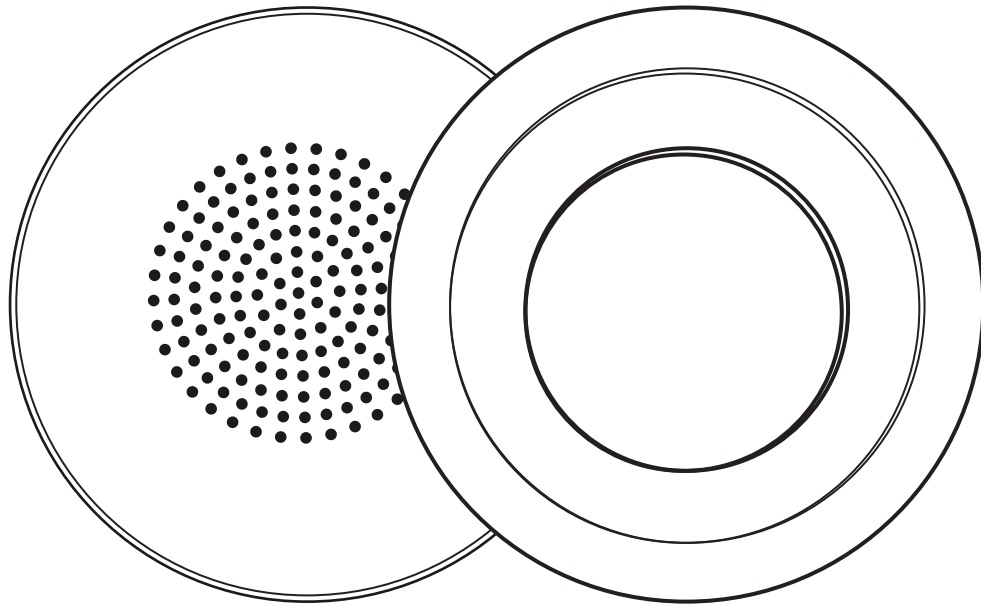

CONTENTS

English3

简体中文7

繁體中文 11

한국어 15

Indonesia 19

KNOW YOUR PRODUCT

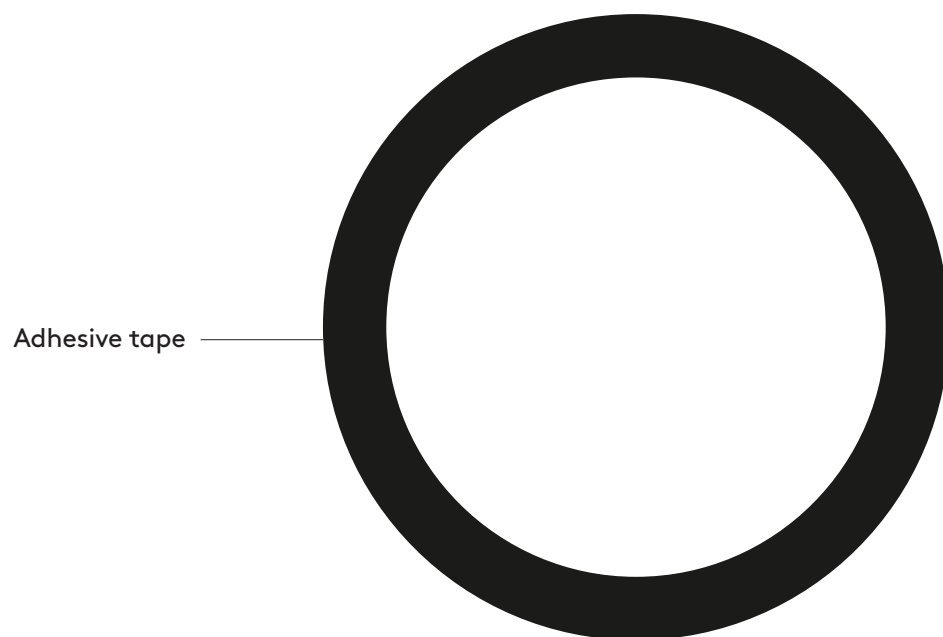
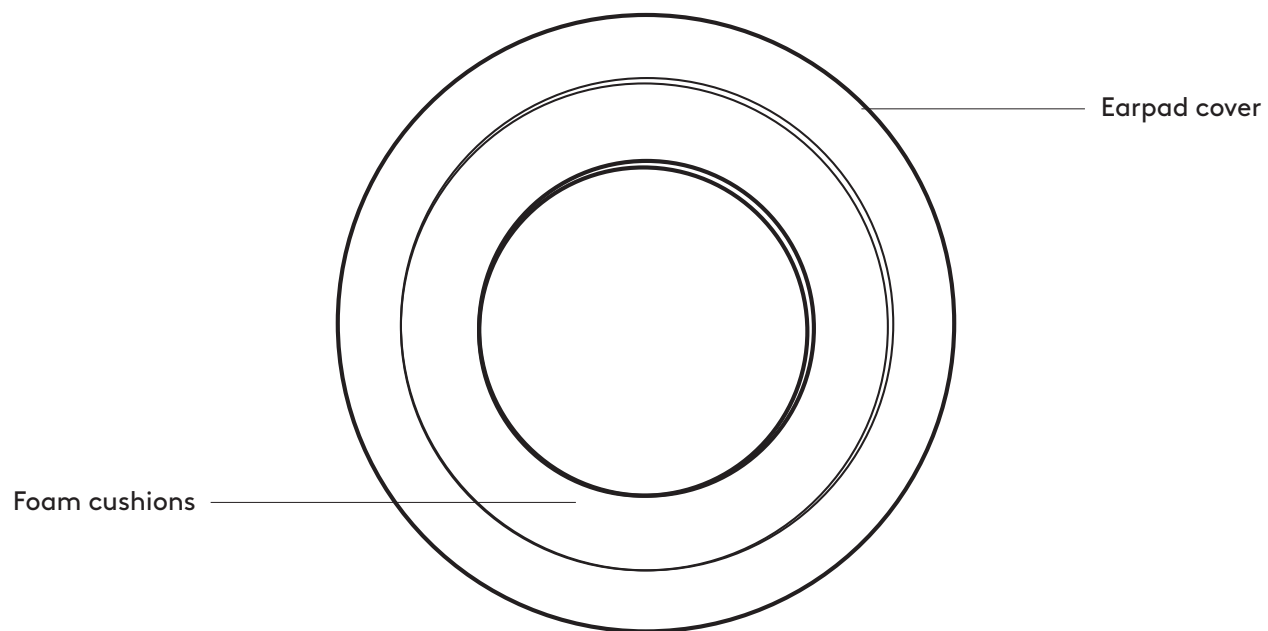

WHAT'S IN THE BOX

1. 1 pair (2 pcs) of replaceable earpad covers
2. 1 pair (2 pcs) of foam cushions
3. 1 pair (2 pcs) of adhesive tapes

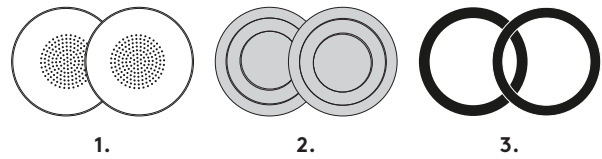

REPLACING EARPAD COVERS

1. Take the existing earpad cover off by carefully pinching the cover.

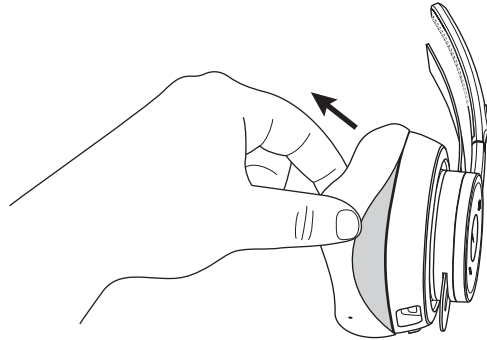

2. Remove the earpad cover slowly until it is completely off.

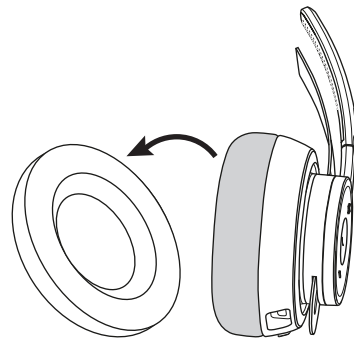

Make sure not to pinch the foam cushion which can be damaged easily.

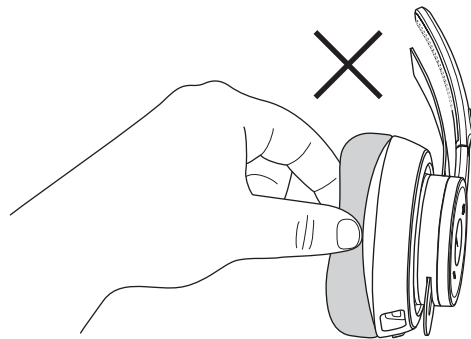

3. If foam cushion is damaged, please follow the steps below.
- Peel the foam cushion off and replace with a new one.

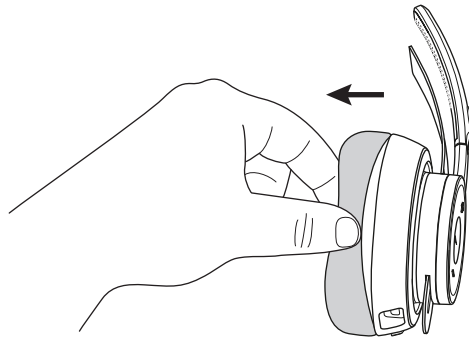

- Place the tape on the top of the ear cup first.

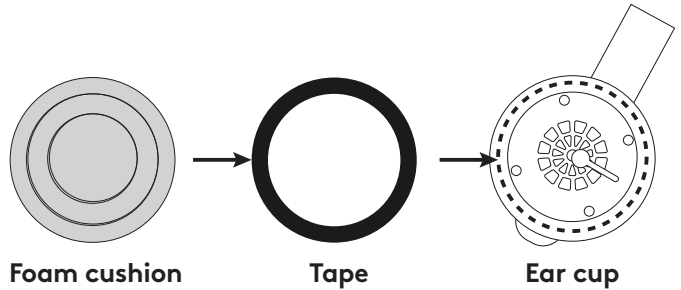

- Then attach the foam cushion to the tape.

4. Grasp the new earpad cover, making sure that the small holes on the side align with the top and bottom of the ear cup. It should align with the USB C port at the bottom.

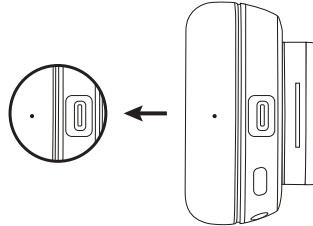

5. Starting from the top, slot the edge of the earpad cover inside the gap. Put the edge of the cover into the gap around the earcan.

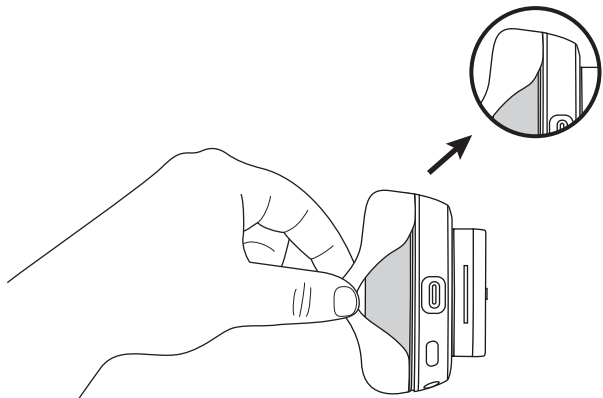

6. After completing, gently pat the earcup several times to push the air out.

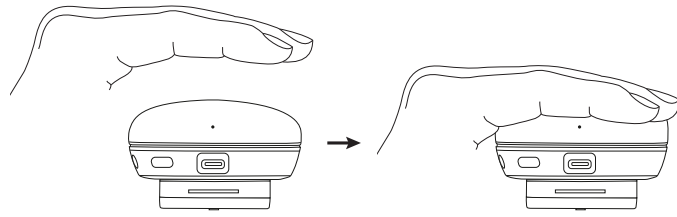

DIMENSIONS

EARPAD COVERS:

Height x Width x Depth: 70.7 mm x 70.7 mm x 16.4 mm

www.logitech.com/support/zone900

了解您的产品

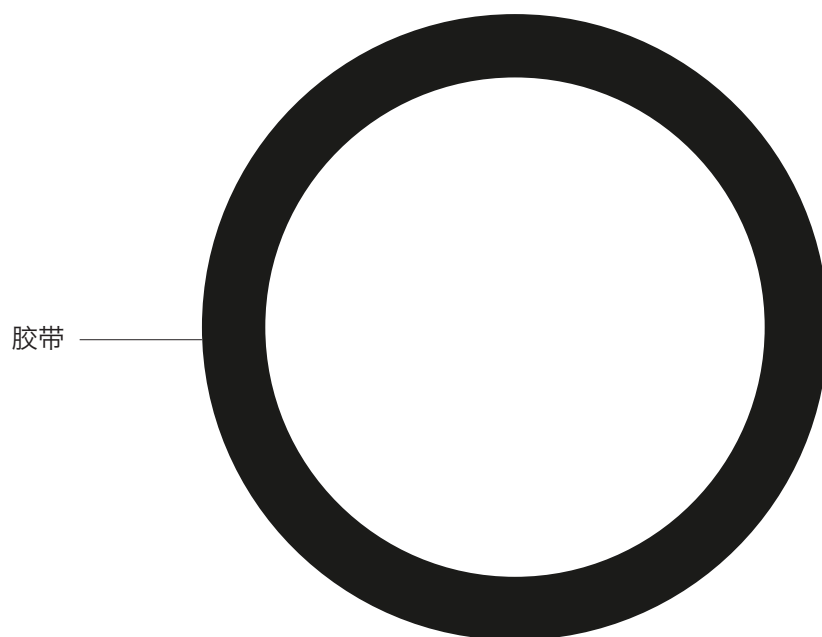
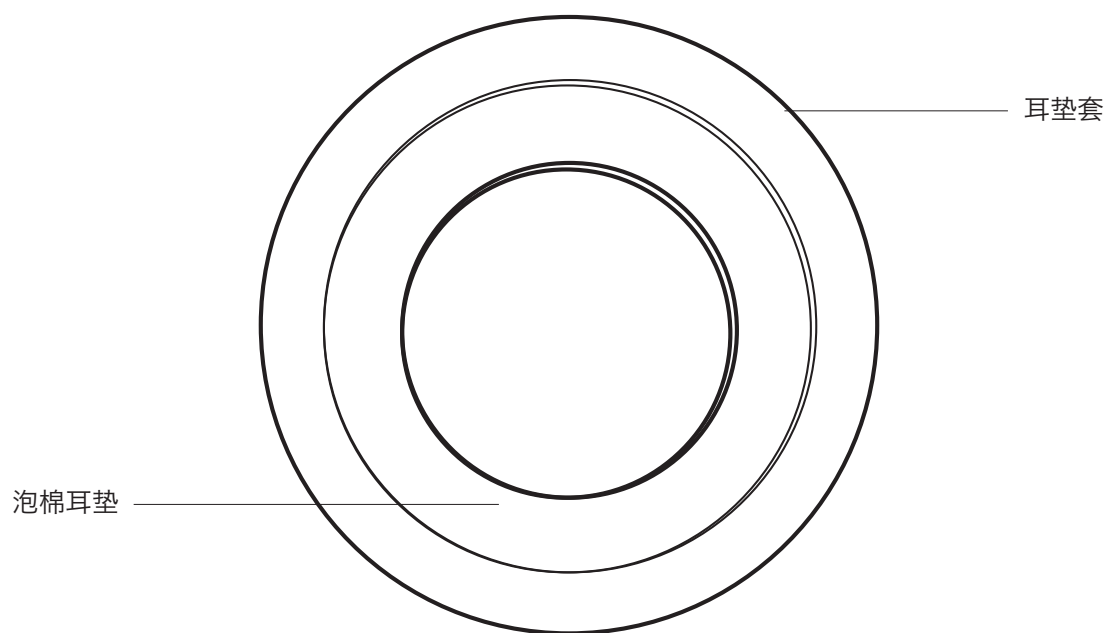

包装内容

1. 1对 (2只) 替换耳垫套
2. 1对 (2只) 泡棉耳垫
3. 1对 (2个) 胶带

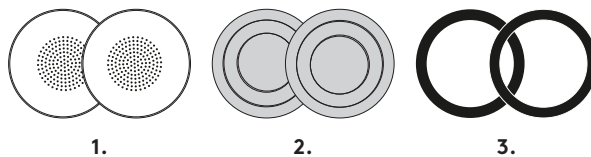

替换耳垫套

1. 轻轻捏住耳垫套向外拉拽。

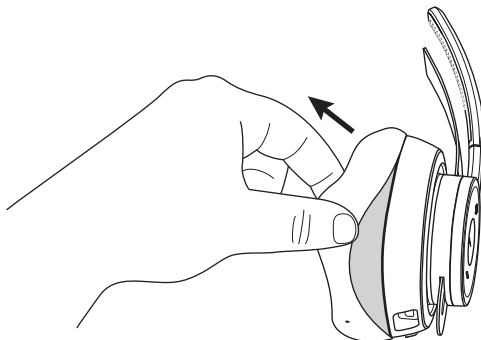

2. 慢慢取下耳垫套，直至完全取下。

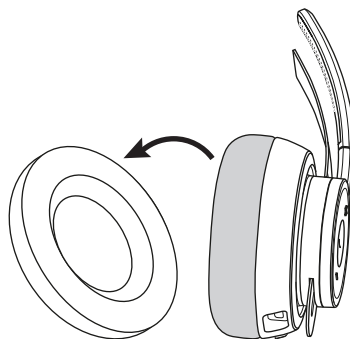

请确保不要挤压容易损坏的泡棉耳垫。

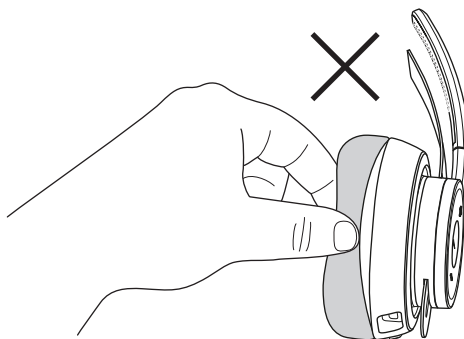

3. 如果泡棉耳垫损坏，请执行以下步骤。
a. 取下泡棉耳垫并更换。

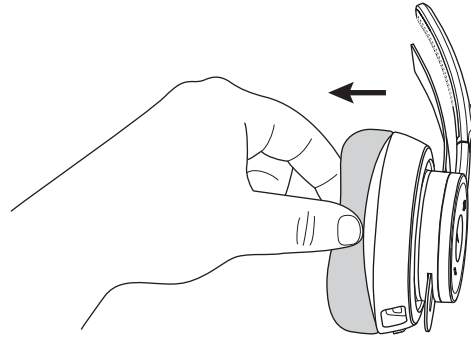

- b. 首先将胶带贴在耳罩上。

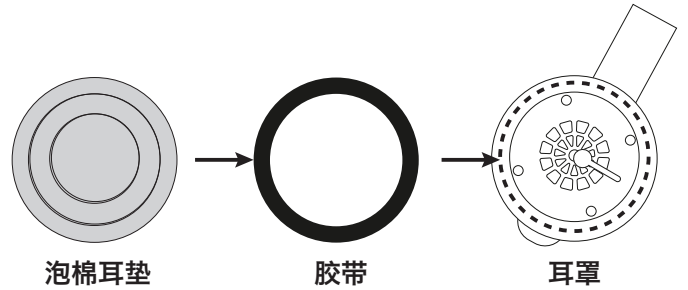

- c. 然后将泡棉耳垫粘到胶带上。

4. 拿起新的耳垫套，确保侧面的小孔与耳罩的顶部和底部对齐。应与底部的 USB C 端口对齐。

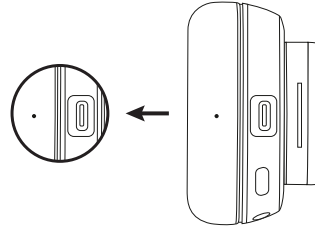

5. 从顶部开始，将耳垫套的边缘嵌入间隙中。将耳垫套的边缘嵌入耳罩周围的空隙中。

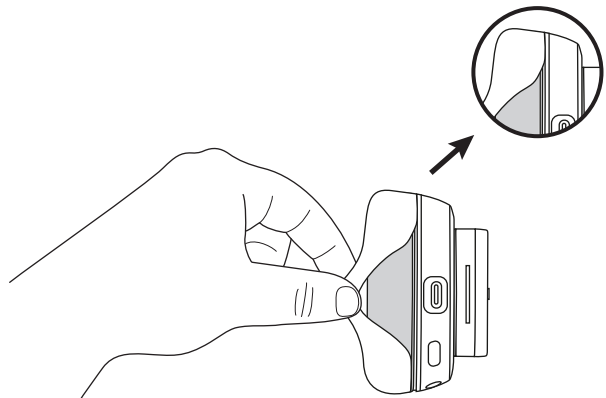

6. 完成后，轻拍几次耳罩，将空气排出。

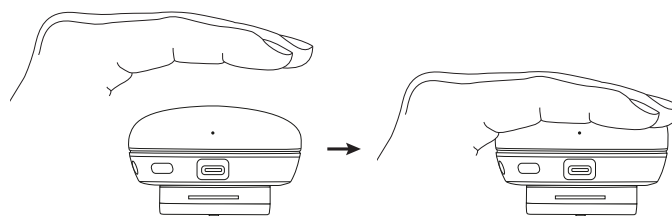

规格

耳垫套:

高 x 宽 x 深: 约 70.7 毫米 x 约 70.7 毫米 x 约 16.4 毫米

www.logitech.com/support/zone900

瞭解您的產品

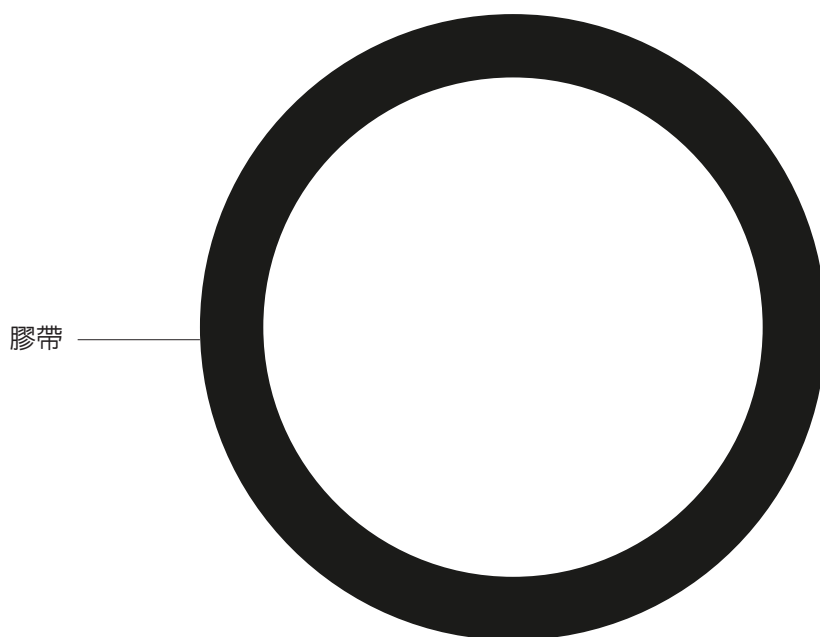
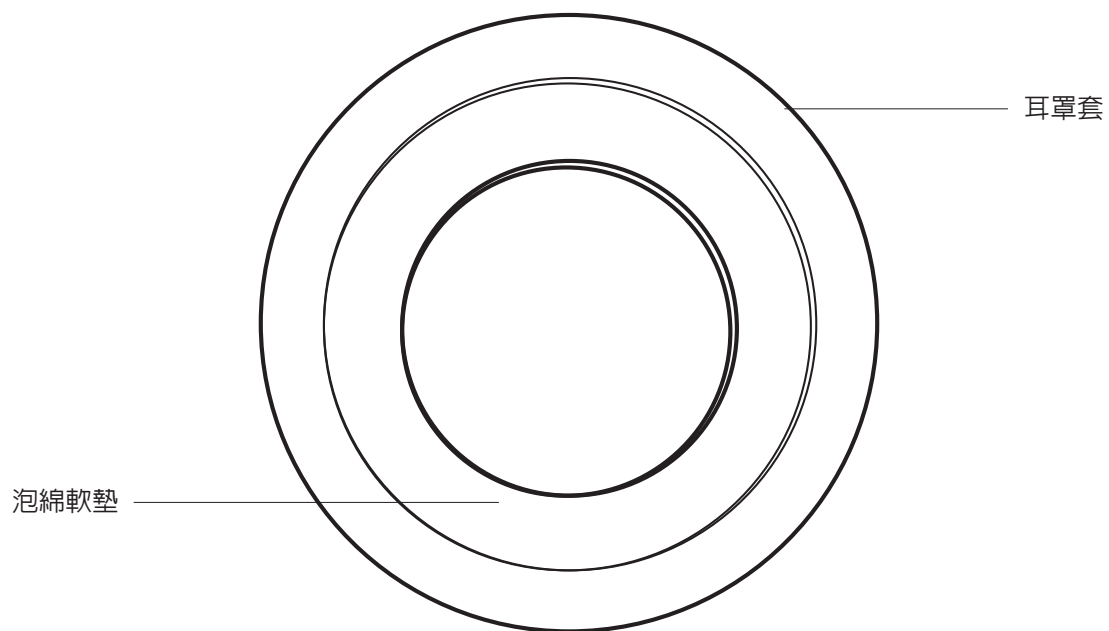

包裝內容

1. 1對 (2個) 可更換耳罩套
2. 1對 (2個) 泡綿耳墊
3. 1對 (2條) 膠帶

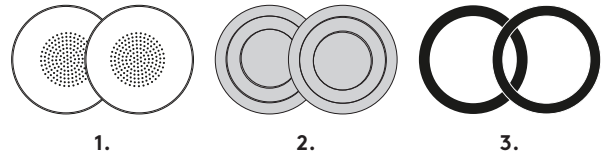

更換耳罩套

1. 小心捏住現有的耳罩套，將其取下。

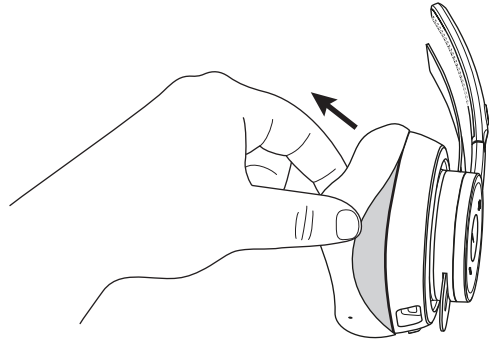

2. 慢慢取出耳罩套，直到其完全脫離。

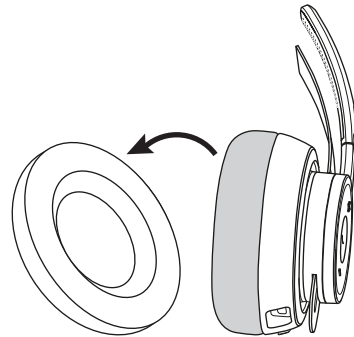

確認不要捏住容易受損的泡綿軟墊。

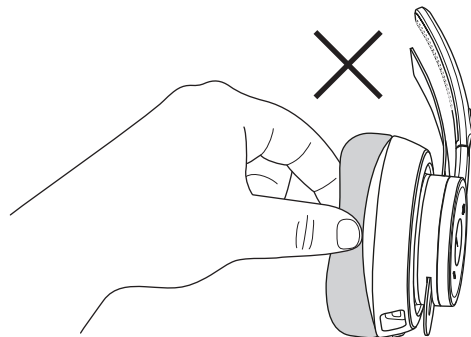

3. 如果泡綿軟墊受損，請依照下列步驟。

a. 剝下泡綿軟墊，以新的替換。

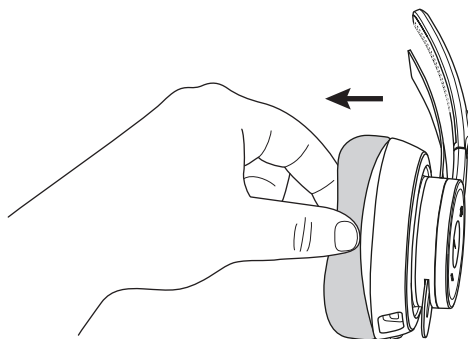

b. 先將膠帶放在耳罩上方。

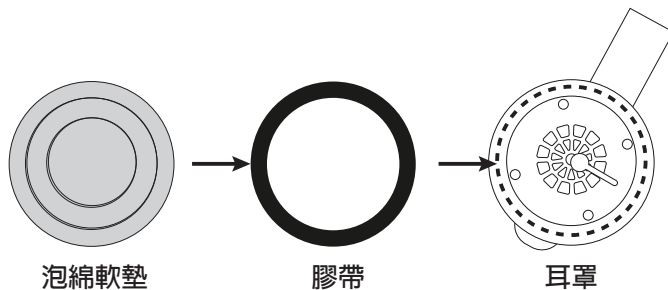

c. 然後將泡綿軟墊貼到膠帶上。

4. 握住新的耳罩套，確認側邊的小孔對齊耳罩的上緣和下緣。其應對齊底部的 USB-C 連接埠。

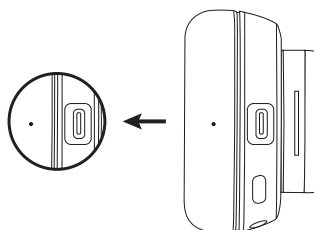

5. 由上而下，將耳罩套的邊緣插入溝槽中。將耳罩套的邊緣放入耳罩周圍的溝槽中。

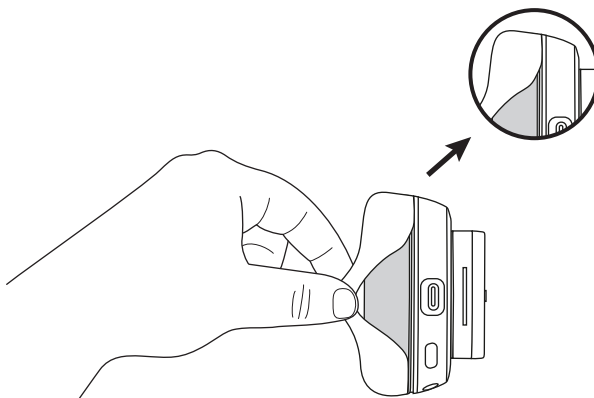

6. 完成後，輕拍幾下耳罩以將空氣排出。

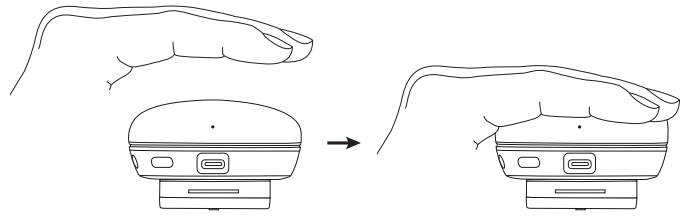

尺寸

耳罩套：

高 x 寬 x 深：70.7 公釐 x 70.7 公釐 x 16.4 公釐

www.logitech.com/support/zone900

제품 설명

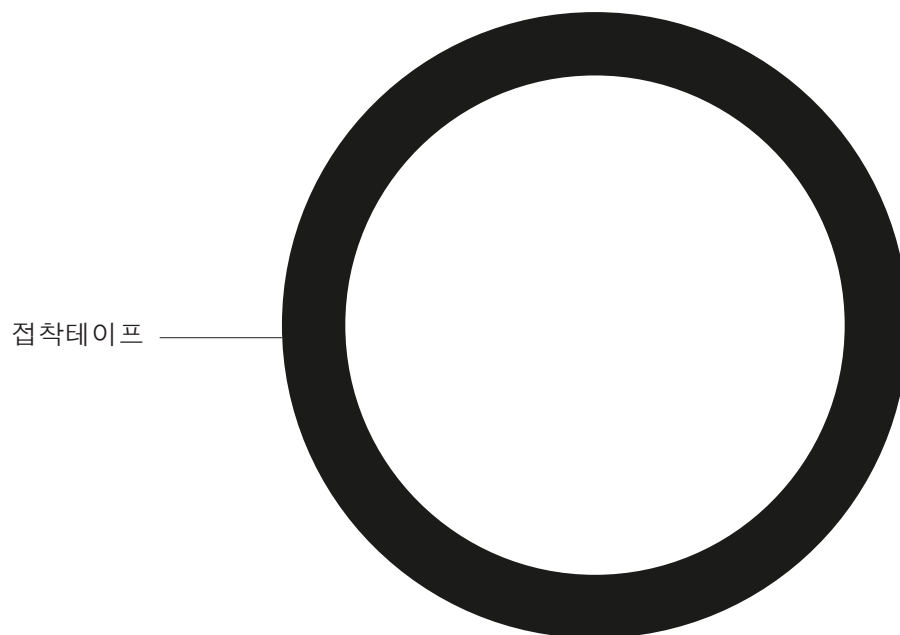
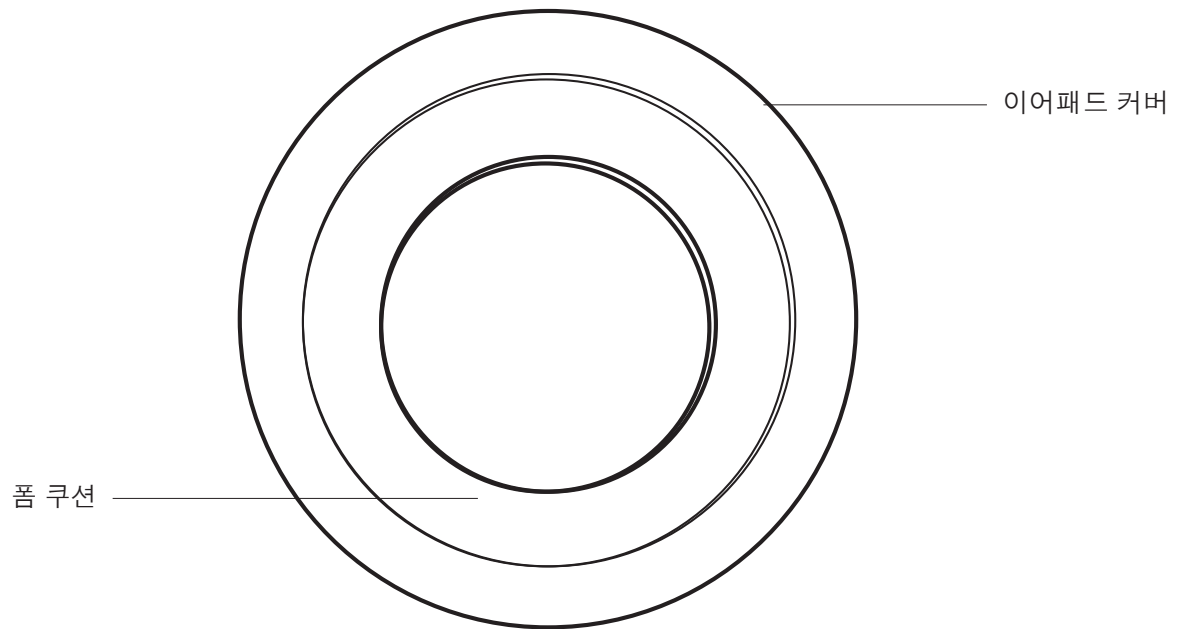

박스 내용물

1. 1쌍(2개)의 교체용 이어패드 커버
2. 폼 쿠션 1쌍(2개)
3. 접착테이프 1쌍(2개)

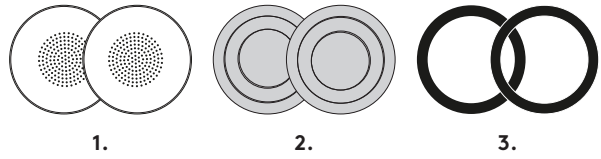

이어패드 커버 교체

1. 커버를 살짝 집어 기존의 이어패드 커버를 벗겨냅니다.

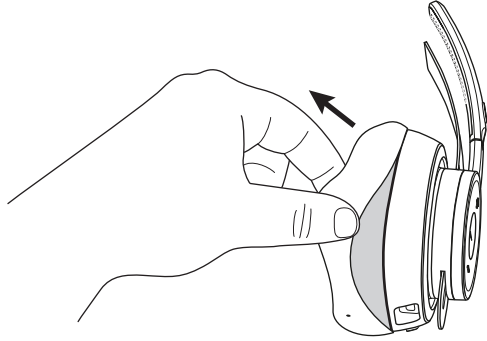

2. 이어패드 커버가 완전히 벗겨질 때까지 천천히 잡아당깁니다.

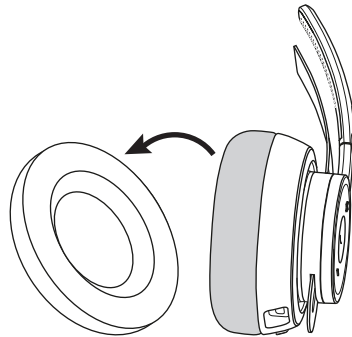

폼 쿠션은 쉽게 손상될 수 있으니 그 부분을 잡지 않도록 주의하십시오.

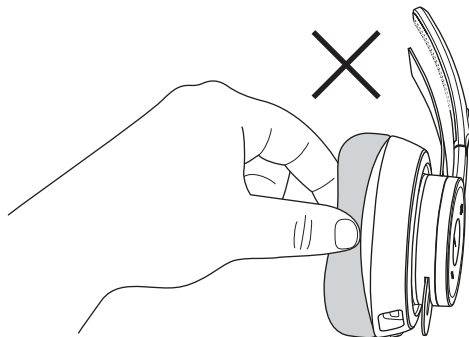

3. 폼 쿠션이 손상된 경우, 다음 단계를 따르십시오.
 a. 폼 쿠션을 벗긴 뒤 새것으로 교체합니다.

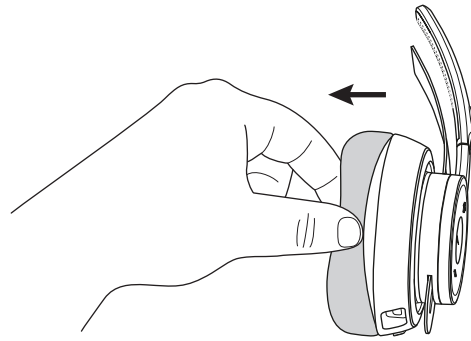

- b. 먼저 이어 컵 위에 테이프를 붙입니다.

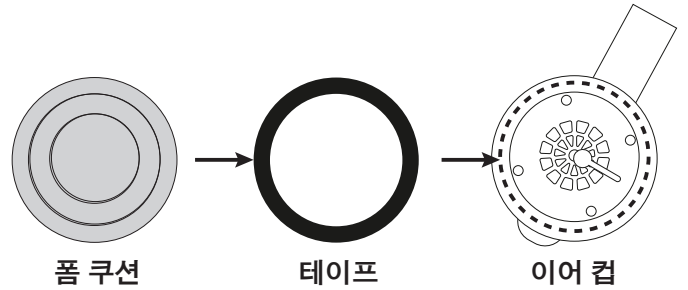

- c. 그다음 테이프에 폼 쿠션을 붙입니다.

4. 새 이어패드 커버를 잡고 이어 컵 상단 및 하단에 측면에 있는 작은 구멍이 일치하는지 확인합니다. 하단에 있는 USB C 포트와 맞아야 합니다.

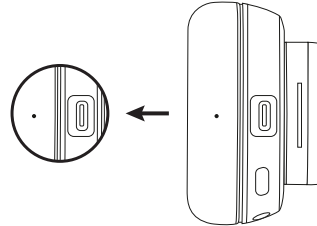

5. 상단부터 이어패드 커버의 가장자리를 틈 안으로 밀어 넣습니다. 귀 덮개 주변의 틈으로 커버의 가장자리를 넣습니다.

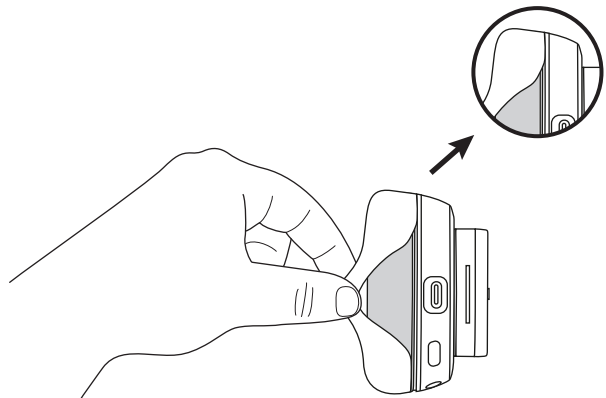

6. 완료한 뒤에는 이어컵을 몇 번 두드려 공기를 빼냅니다.

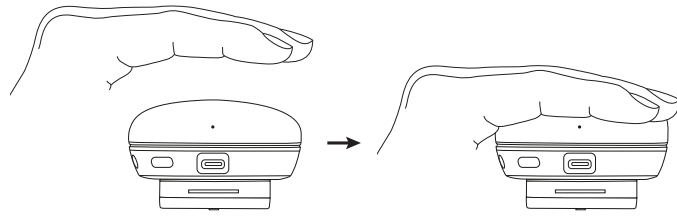

규격

이어패드 커버:

높이 x 너비 x 깊이: 70.7mm x 70.7mm x 16.4mm

www.logitech.com/support/zone900

MENGENAL PRODUK

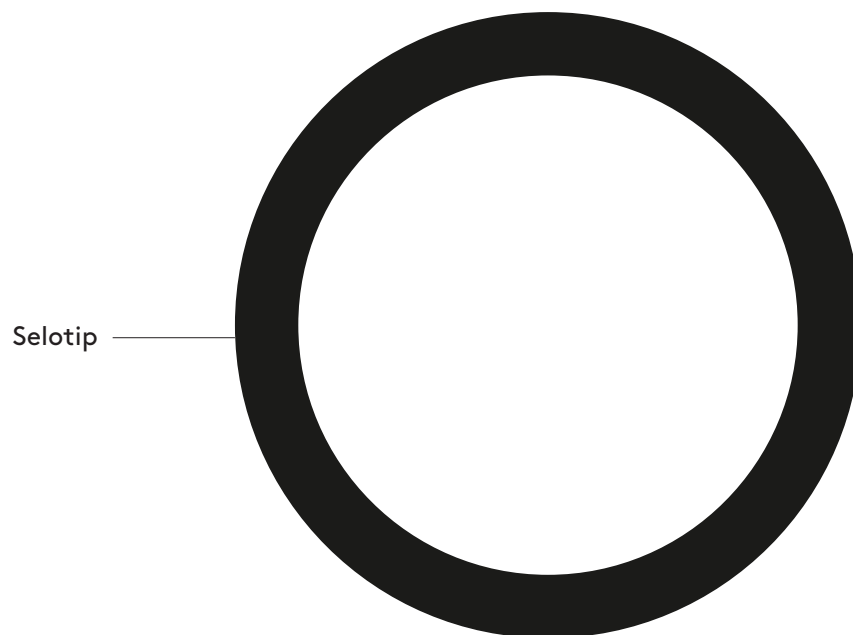
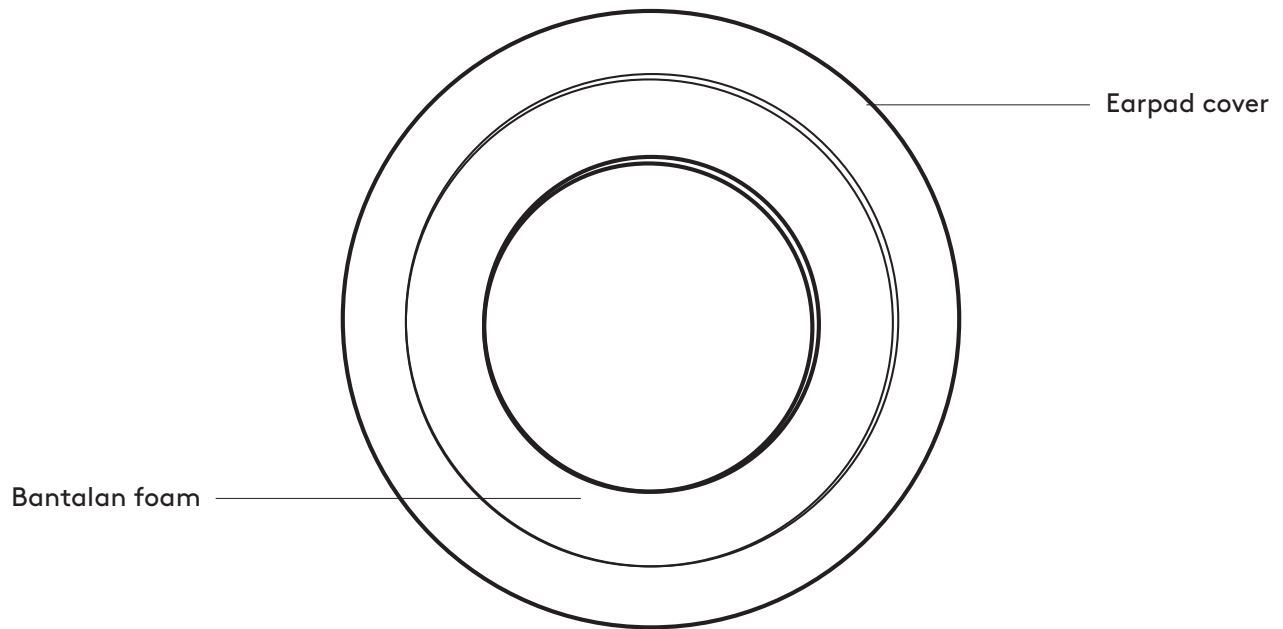

ISI KEMASAN

1. 1 pasang (2 pcs) earpad cover yang bisa diganti
2. 1 pasang (2 pcs) bantalan busa
3. 1 pasang (2 pcs) selotip

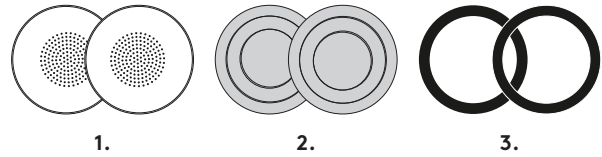

MENGGANTI EARPAD COVER

1. Lepaskan earpad cover dengan berhati-hati mencubit cover-nya.

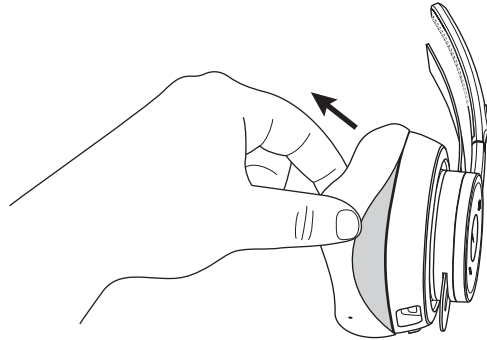

2. Tarik earpad cover perlahan-lahan sampai benar-benar lepas.

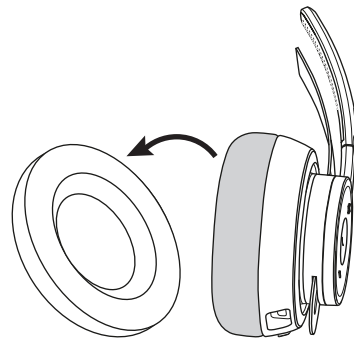

Pastikan untuk tidak menarik bantalan busa yang mudah rusak.

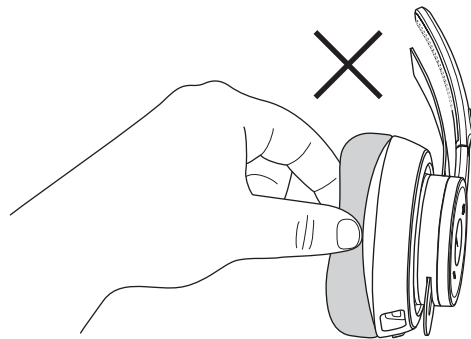

3. Jika bantalan busa rusak, maka ikuti langkah-langkah berikut.
- Lepaskan bantalan busa dan ganti dengan yang baru.

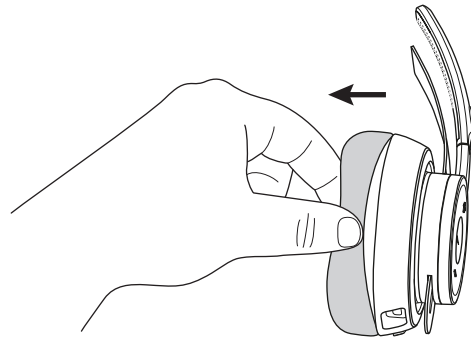

- Pertama-tama pasang selotip di bagian atas ear cup.

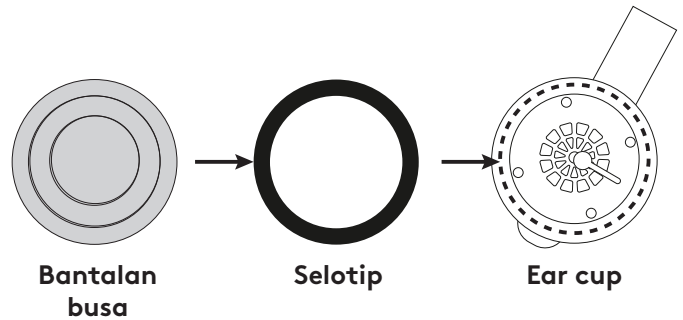

- Kemudian tempelkan bantalan busa ke selotip.

4. Pegang earpad cover baru, pastikan lubang kecil di kedua sisinya sejajar dengan bagian atas dan bawah ear cup. Ia seharusnya sejajar dengan port USB C di bagian bawah.

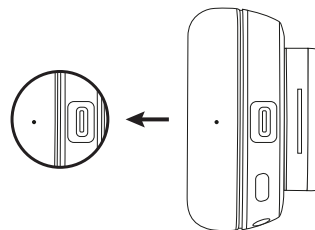

5. Mulai dari atas, masukkan bagian pinggir earpad cover ke dalam celah. Masukkan seluruh bagian pinggir cover ke dalam celah di seputar earcan.

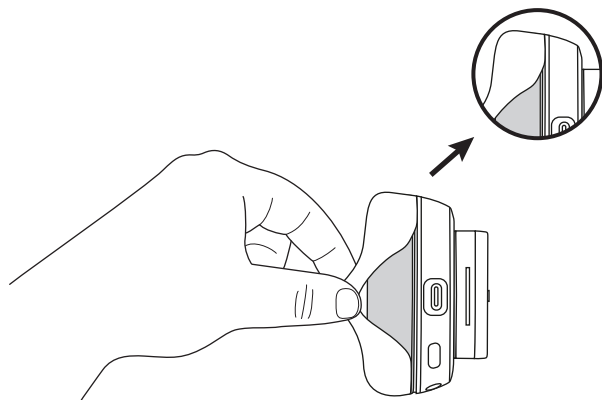

6. Setelah selesai, tepuk earcup beberapa kali dengan lembut untuk mengeluarkan udara dari dalam.

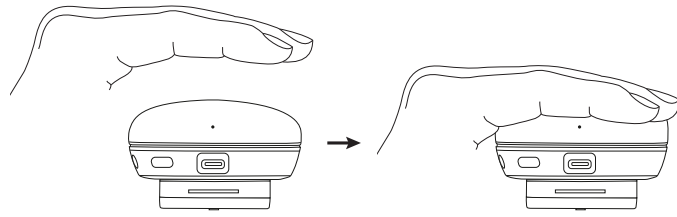

DIMENSI

EARPAD COVER:

Tinggi x Lebar x Tebal: 70,7 mm x 70,7 mm x 16,4 mm

www.logitech.com/support/zone900