

G435 SE

SETUP GUIDE | GUIDE D'INSTALLATION





ENGLISH 3
FRANÇAIS 13
ESPAÑOL 23
PORTUGUÊS 33

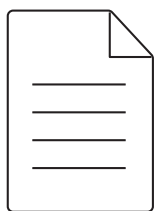
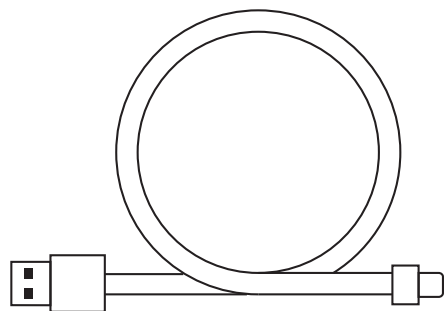
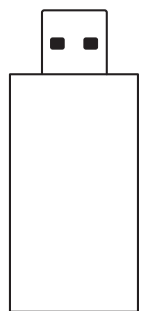
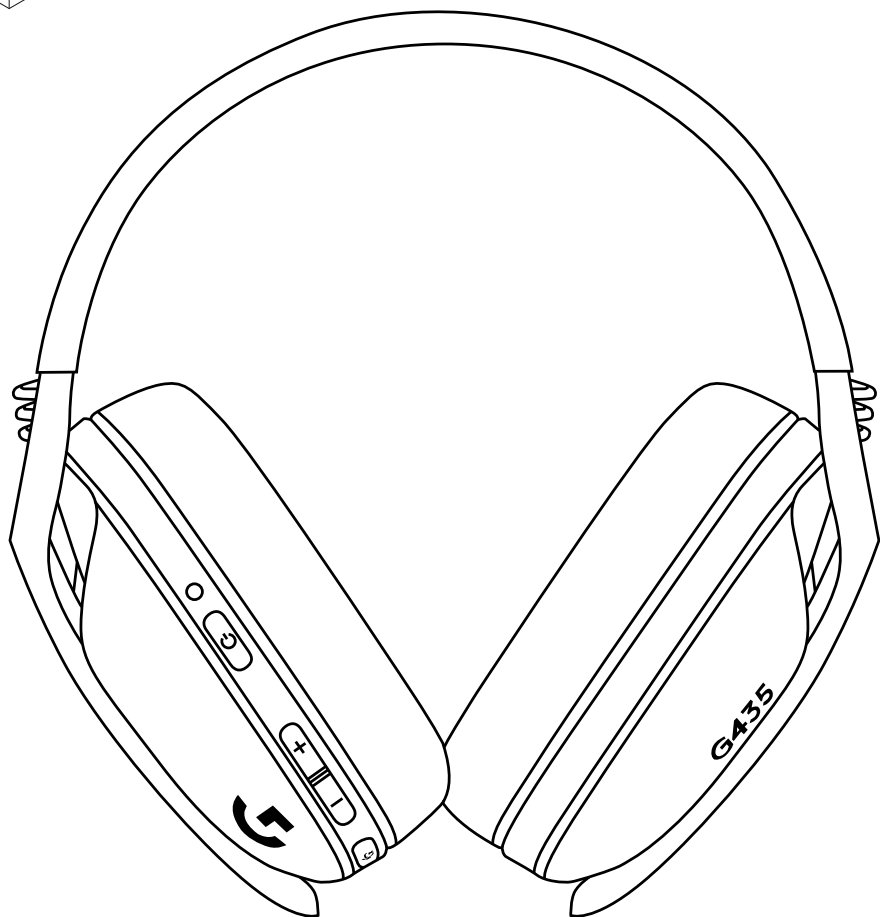

CLEANING THE LOGITECH G435 SE

In the event your Logitech G435 SE needs cleaning we have some recommendations:

Before You Clean

- Do not wash your ear pads in a washing machine
- Do not dry your ear pads in a tumble dryer
- Don't put cleaning liquids directly on your ear pads and headband.
- Don't use bleach, acetone/nail polish remover, strong solvents, or abrasives as it might affect the polyester fabric surface condition and cause discoloration.
- When using cleaning sprays, spray on the cloth and wipe — do not spray the product directly.

Wiping and Cleaning Your G435 SE

- To wipe or clean the headset, use regular tap water to lightly moisten a clean, soft, lint-free cloth and gently wipe down the headband and ear pads.
- For heavier stains, you might additionally use a small amount of soap on the lightly moisten, clean, soft cloth and gently rub stained areas. Rinse thoroughly the surface by using the same moisten cloth. Repeat until all traces of soap are gone.
- You can also use fragrance-free disinfecting wipes, fragrance-free anti-bacterial wet wipes.
- Let it dry at room temperature.

Logitech encourages users to properly sanitize their products in accordance with guidelines put out by the World Health Organization and the Centers for Disease Control guidelines.

CONNECTING YOUR HEADSET USING LIGHTSPEED

Connect to your PC, Mac, PlayStation 5 or 4 with LIGHTSPEED Wireless Technology

- Insert receiver into the USB port of your device.

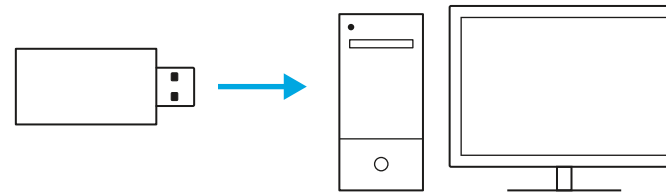

- Press the Power button for minimum 1.5 sec.
- The LED turns cyan once connected.

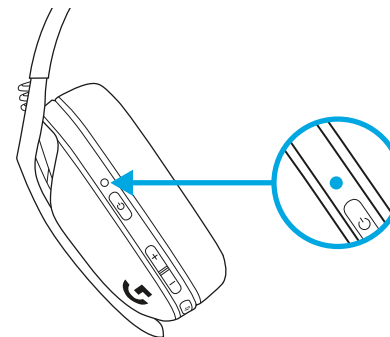
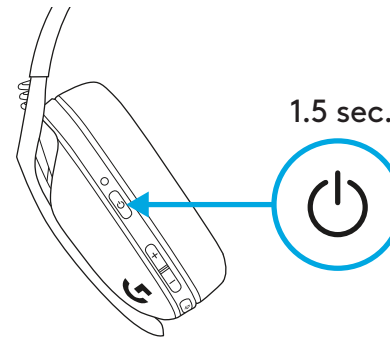

HOW TO CONNECT YOUR G435 SE USING *BLUETOOTH*

- Press Power+Mute buttons for 3 seconds or longer.

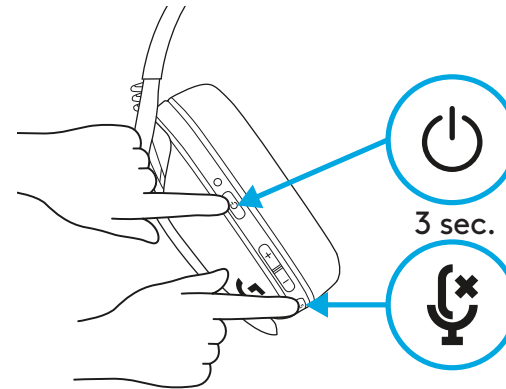

- LED will flash **blue** as it enters pairing mode.

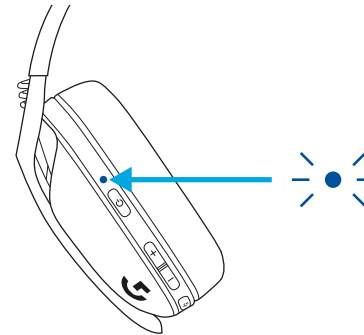

- Look for G435 SE under the *bluetooth* list of your device and connect.
- Note: G435 SE can connect to a single *Bluetooth* device at a time.

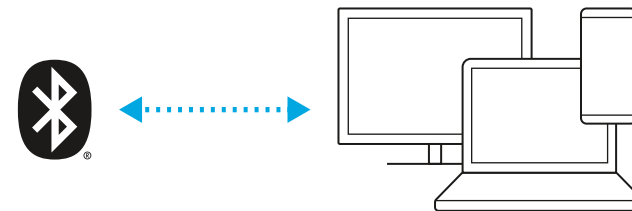

HOW TO SWITCH THE CONNECTION MODE BETWEEN LIGHTSPEED AND *BLUETOOTH* ON G435 SE

- Press the Mute button for 3 seconds or longer.

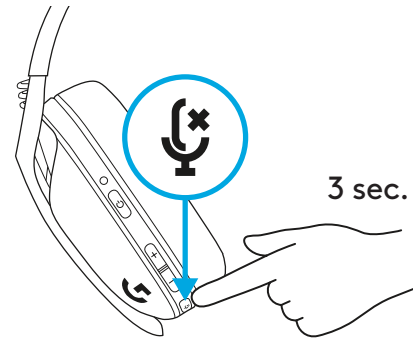

- Switch to LIGHTSPEED, LED will light cyan for 5 seconds.

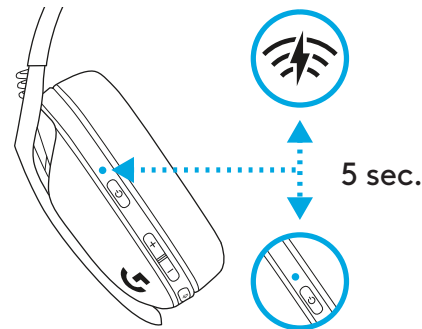

- Switch to *Bluetooth*, LED will light blue for 5 seconds.

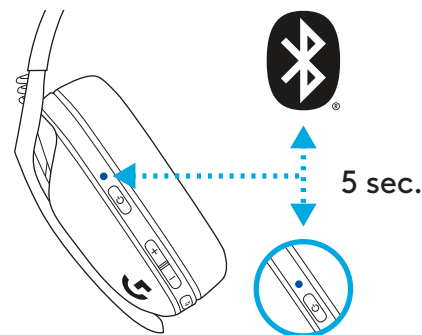

HOW TO POWER ON AND OFF YOUR G435 SE

Power ON

- Press the Power button for 1.5 seconds when the headset is OFF.

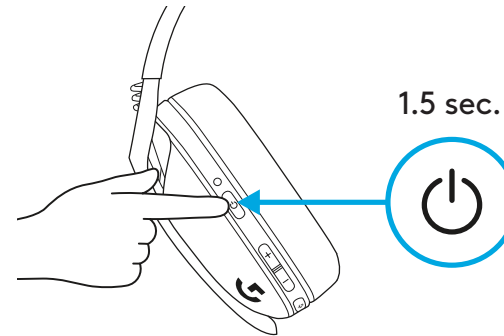

Power OFF

- Press the Power button for 3 seconds when the headset is ON.

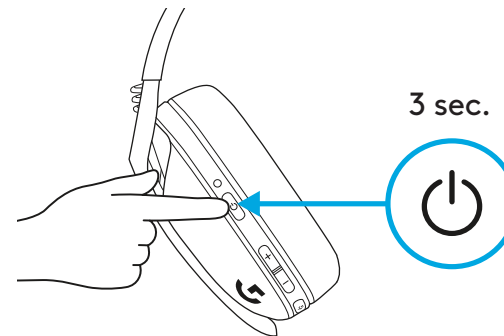

Auto Shutoff

- G435 SE automatically shuts off after 30 minutes of inactivity.

CHECK YOUR BATTERY LEVEL OF YOUR G435 SE

- Single press the Power button, when headset is ON

- LED will show **green** for 5 seconds, which means Battery is between 31% to 100%.

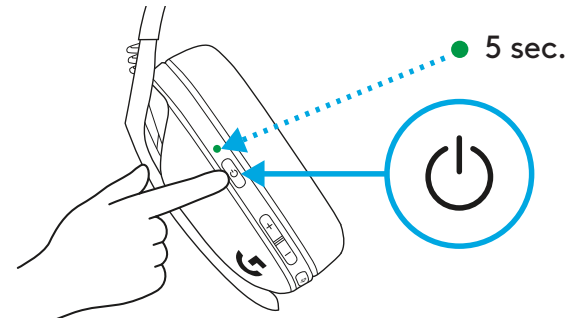

- LED will show **red** for 5 seconds, which means Battery is between 15% to 30%.

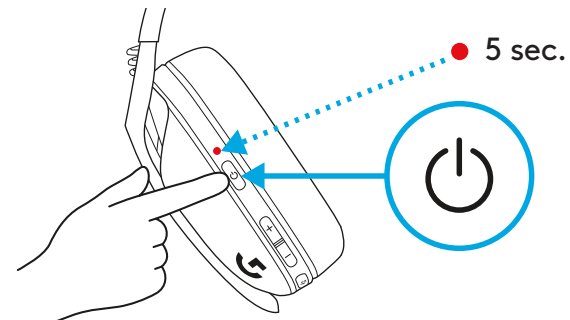

- LED will flash **red** for 5 seconds, which means Battery level is <15%.

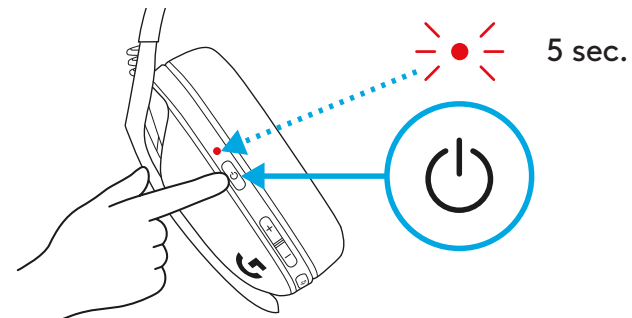

SET THE SIDETONE ON YOUR G435 SE

Sidetone lets you hear your voice while communicating with other people. It mirrors the experience of talking on a phone and allows you to adjust your speaking volume to a proper level.

- Enable Sidetone

- Double press the Mute button and the LED will flash twice in **orange**.

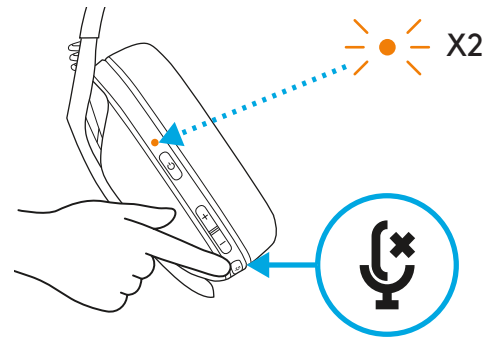

- Disable Sidetone

- Double press the Mute button and the LED will flash once in **orange**.

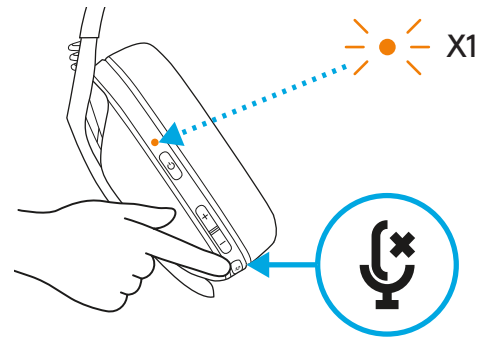

- Adjust Sidetone

- UP = Single press Mute button + Volume UP.

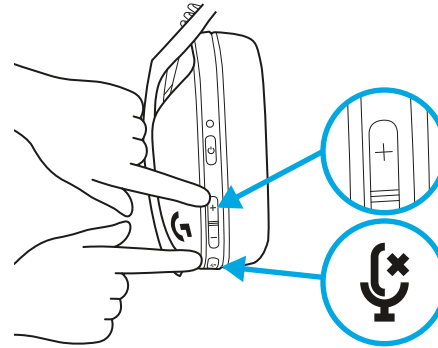

- DOWN = Single press Mute button + Volume DOWN.

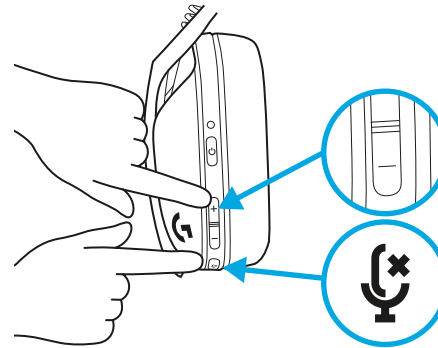

SPARE PARTS

- Earpads
- Wireless USB Receiver
- Charging Cable

RECYCLING

We encourage you to resell or donate working products. Otherwise, batteries, electronic and electrical equipment should not be disposed of with household waste. Wherever possible, they should be segregated and brought to an appropriate collection point to enable recycling and avoid potential impacts on the environment and human health. For more information, contact your local authorities or place of purchase, or visit www.logitech.com/recycling

QUESTIONS?

logitechG.com/support/G435SE

BATTERY REMOVAL

1

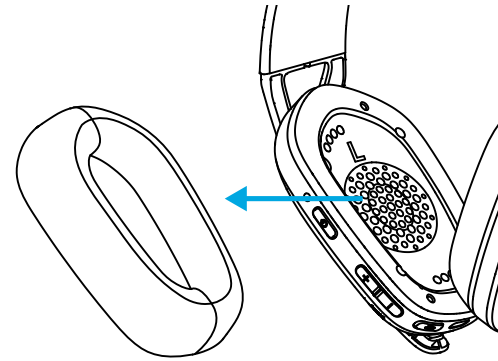

2

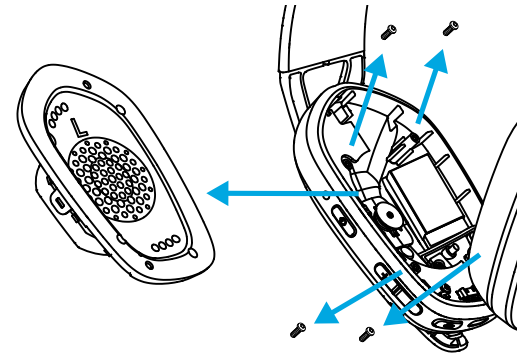

3

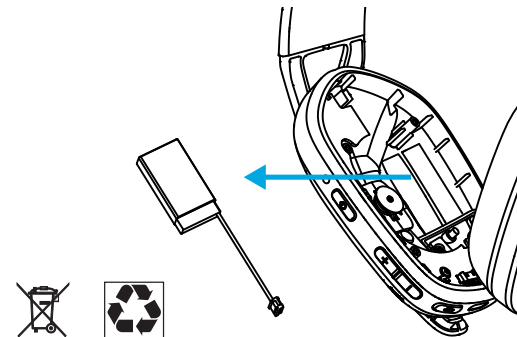

NETTOYAGE DU DISPOSITIF LOGITECH G435 SE

Si votre dispositif Logitech G435 SE a besoin d'être nettoyé, nous avons quelques recommandations:

Avant le nettoyage

- Ne lavez pas vos oreillettes dans une machine à laver
- Ne séchez pas vos oreillettes dans un sèche-linge
- Ne versez pas de produit nettoyant directement sur vos oreillettes ou votre bandeau.
- N'utilisez pas d'eau de Javel, d'acétone ou de dissolvant pour vernis à ongles, de solvants puissants ou d'abrasifs car cela pourrait affecter l'état de la surface du tissu en polyester de l'oreillette et provoquer une décoloration.
- Si vous utilisez des pulvérisateurs de nettoyage, pulvérisez la solution sur le chiffon et nettoyez. Ne pulvérisez pas directement le produit.

Essuyage et nettoyage de votre dispositif G435 SE

- Pour essuyer ou nettoyer le casque, imbitez légèrement d'eau du robinet un chiffon doux non pelucheux, et nettoyez le bandeau et les oreillettes.
- Pour les taches plus tenaces, vous pouvez également utiliser une petite quantité de savon sur le chiffon légèrement humidifié, propre et doux, et frotter doucement les zones tachées. Rincez soigneusement la surface en utilisant le même chiffon humidifié. Répétez l'opération jusqu'à ce que toutes les traces de savon aient disparu.
- Vous pouvez également utiliser des lingettes désinfectantes sans parfum ou des lingettes humides antibactériennes sans parfum.
- Laissez sécher à température ambiante.

Logitech encourage les utilisateurs à désinfecter correctement leurs produits conformément aux directives publiées par l'Organisation mondiale de la santé et aux directives des Centres pour le contrôle et la prévention des maladies.

CONNEXION DE VOTRE CASQUE VIA LIGHTSPEED

Connectez-vous à votre PC, Mac, PlayStation 5 ou 4 avec la technologie sans fil LIGHTSPEED

– Insérez le récepteur dans le port USB de votre dispositif.

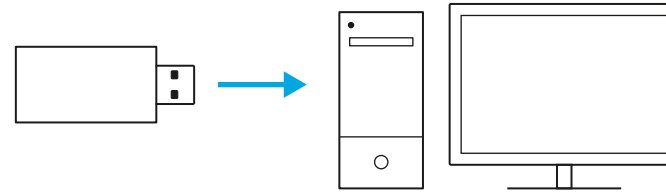

– Maintenez le bouton Marche/Arrêt enfoncé pendant au moins 1.5 seconde.

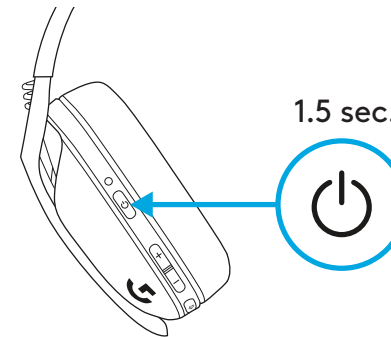

– Une fois la connexion effectuée, le témoin lumineux devient cyan.

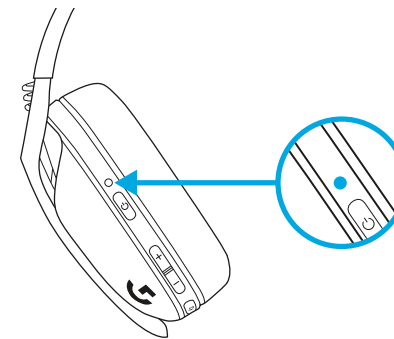

COMMENT CONNECTER LE DISPOSITIF G435 SE À L'AIDE DU *BLUETOOTH*

- Appuyez pendant au moins 3 secondes sur le bouton Marche/Arrêt et Sourdine.

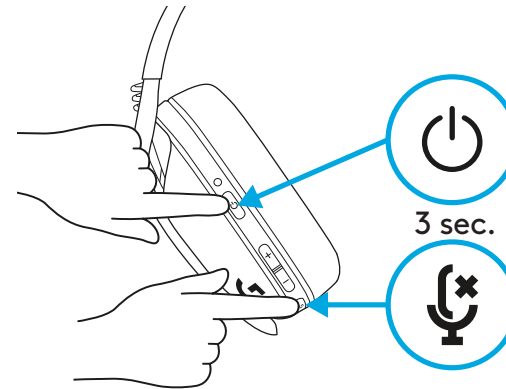

- Le témoin lumineux clignotera en **bleu** en entrant en mode de couplage.

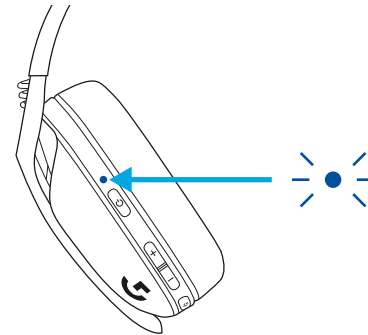

- Recherchez G435 SE dans la liste *Bluetooth* de votre dispositif et connectez-vous.
- Remarque: G435 SE peut se connecter à un seul dispositif *Bluetooth* à la fois.

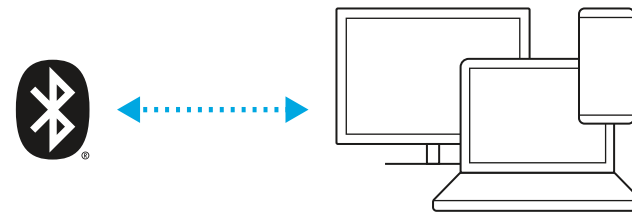

COMMENT BASCULER ENTRE LES MODES DE CONNEXION LIGHTSPEED ET *BLUETOOTH* SUR G435 SE

- Appuyez pendant au moins 3 secondes sur le bouton Sourdine.

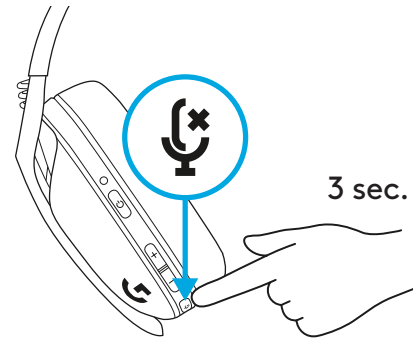

- En passant sur LIGHTSPEED, le voyant lumineux s'allumera en **cyan** pendant 5 secondes.

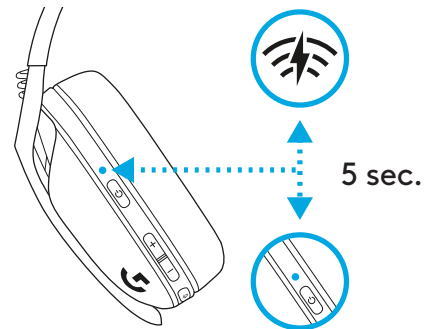

- En passant sur *Bluetooth*, le témoin lumineux s'allumera en **bleu** pendant 5 secondes.

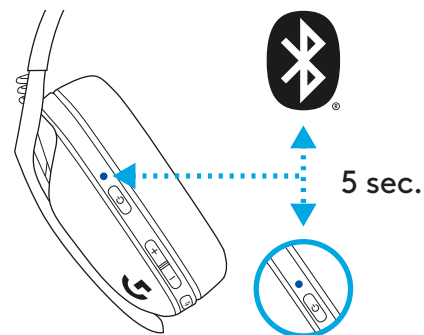

COMMENT METTRE VOTRE DISPOSITIF G435 SE SOUS TENSION OU HORS TENSION

Mise sous tension

- Appuyez sur le bouton Marche/Arrêt pendant 1,5 seconde lorsque le casque est hors tension.

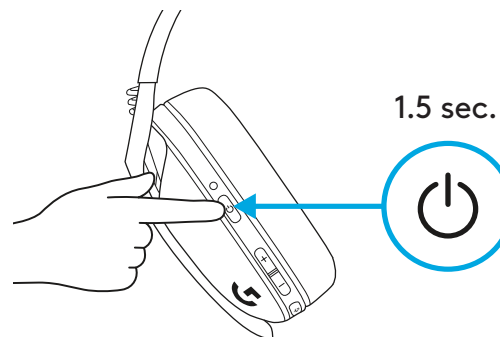

Mise hors tension

- Appuyez sur le bouton Marche/Arrêt pendant 3 secondes lorsque le casque est sous tension.

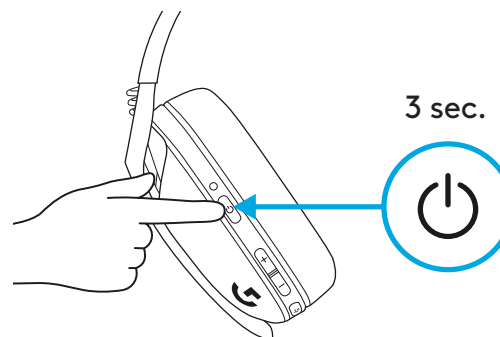

Mise hors tension automatique

- G435 SE se coupe automatiquement après 30 minutes d'inactivité.

COMMENT BASCULER ENTRE ACTIVER/ DÉSACTIVER LA SOURDINE ET VOLUME MAXI SUR VOTRE DISPOSITIF G435 SE

ACTIVER/DÉSACTIVER la sourdine du micro

- Appuyez brièvement sur le bouton Sourdine.

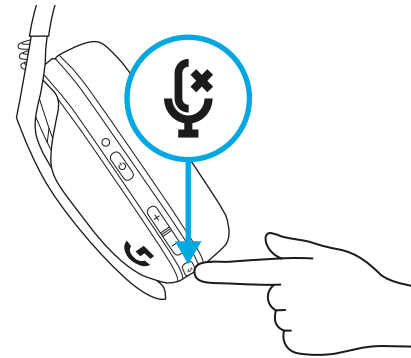

Définir sur le volume maximum

- Définir sur 100 dB
 - Appuyez pendant au moins 3 secondes sur le bouton Sourdine et Volume+.
 - Le témoin lumineux clignotera en orange 3 fois.

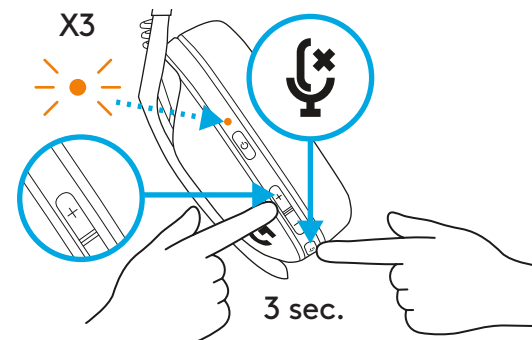

- Définir sur 85 dB
 - Appuyez pendant au moins 3 secondes sur le bouton Sourdine et Volume-.
 - Le témoin lumineux s'allume en orange pendant 5 secondes.

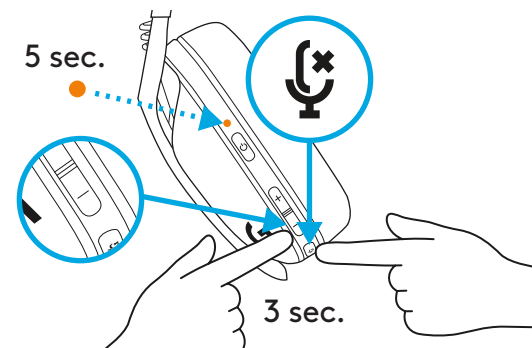

CONTRÔLER LE NIVEAU DE VOTRE BATTERIE SUR LE DISPOSITIF G435 SE

- Appuyez une fois sur le bouton Marche/Arrêt lorsque le casque est sous tension.
- Le témoin lumineux s'allume en **vert** pendant 5 secondes, ce qui signifie que la batterie est chargée de 31% à 100%.

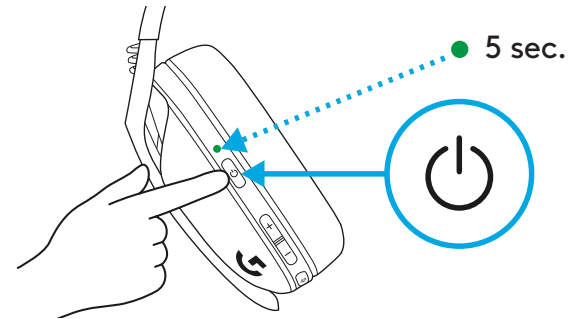

- Le témoin lumineux s'allume en **rouge** pendant 5 secondes, ce qui signifie que la batterie est chargée de 15% à 30%.

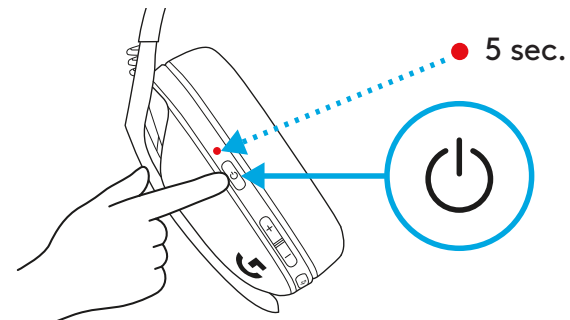

- Le témoin lumineux clignote en **rouge** pendant 5 secondes, ce qui signifie que le niveau de batterie est inférieur à 15%.

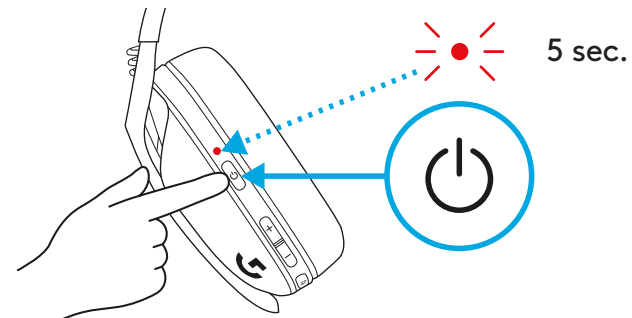

DÉFINIR L'EFFET LOCAL SUR VOTRE DISPOSITIF G435 SE

L'effet local vous permet d'entendre votre voix pendant vos communications avec d'autres. Tout comme pendant une communication téléphonique, vous pouvez régler le volume de votre voix à un niveau adéquat.

– Activer l'effet local

- Appuyez deux fois sur le bouton Sourdine et le témoin lumineux clignotera deux fois en orange.

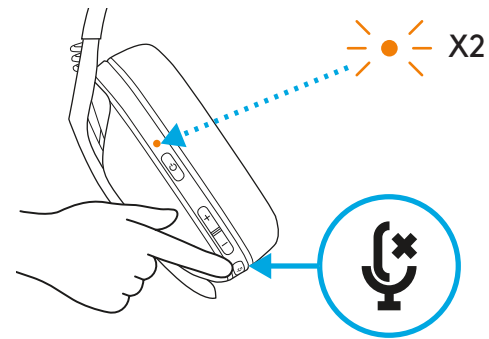

– Désactiver l'effet local

- Appuyez deux fois sur le bouton Sourdine et le témoin lumineux clignotera une fois en orange.

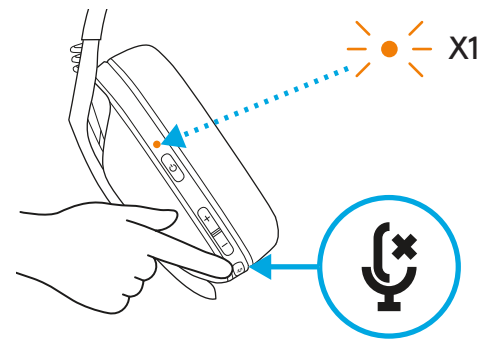

– Réglage de l'effet local

- PLUS = Appuyez une fois sur le bouton Sourdine et Volume+.

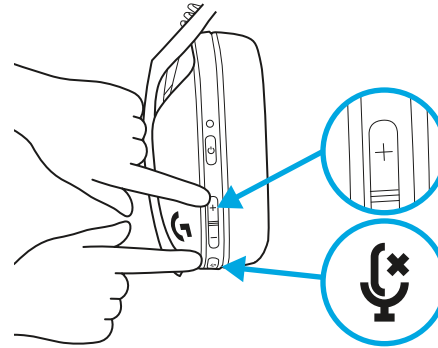

- MOINS = Appuyez une fois sur le bouton Sourdine et Volume-.

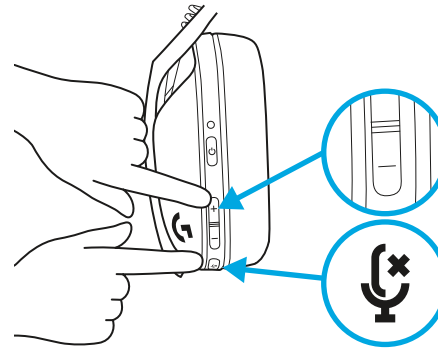

PIÈCES DE RECHANGE

- Oreillettes
- Récepteur USB sans fil
- Câble de charge

RECYCLAGE

Nous vous encourageons à revendre ou à donner les produits fonctionnels. Les piles ainsi que l'équipement électronique et électrique ne doivent pas être jetés avec les déchets ménagers. Dans la mesure du possible, ils doivent être triés et déposés dans un centre de collecte adéquat pour permettre leur recyclage et éviter tout impact potentiel sur l'environnement et la santé humaine. Pour en savoir plus, contactez les autorités locales ou le point de vente, ou rendez-vous sur le site www.logitech.com/recycling

DES QUESTIONS?

logitechG.com/support/G435SE

INSTRUCTIONS DE RETRAIT

1

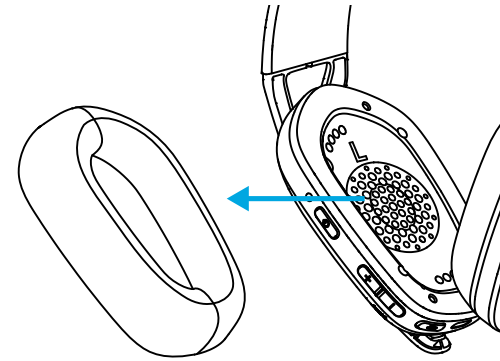

2

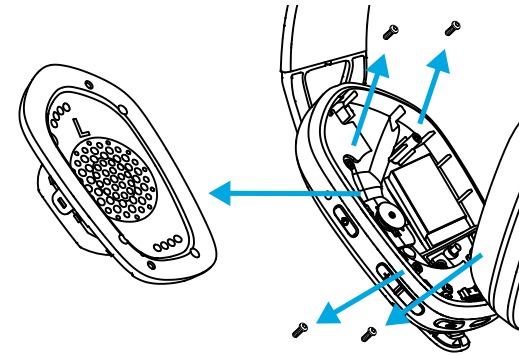

3

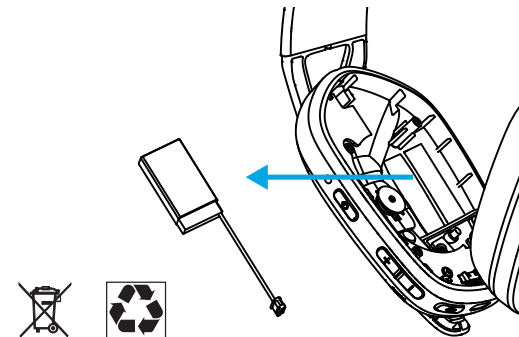

LIMPIAR LOGITECH G435 SE

En caso de que los Logitech G435 necesiten limpieza, tenemos algunas recomendaciones:

Antes de limpiar

- No uses la lavadora para lavar las almohadillas.
- No uses la secadora para secar las almohadillas.
- No eches líquidos limpiadores directamente sobre las almohadillas ni la diadema.
- No utilices lejía, acetona/quitaesmalte, disolventes potentes ni productos abrasivos, ya que podrían decolorar y estropear el tejido superficial de poliéster.
- Si usas aerosoles de limpieza, rocía la bayeta o toallita, no los uses directamente sobre el producto.

Limpia los G435 SE

- Para limpiar los audífonos, utiliza agua del grifo para humedecer un paño suave que no suelte pelusa y frota suavemente la diadema y las almohadillas.
- Si hay manchas más tenaces, puedes añadir un poco de jabón al paño húmedo y frotar las áreas afectadas. Usa el mismo paño humedecido para aclarar la alfombrilla. Repite el aclarado hasta eliminar todo el jabón.
- También puedes usar toallitas desinfectantes antibacterianas no perfumadas.
- Deja secar a temperatura ambiente.

Logitech anima a los usuarios a desinfectar adecuadamente sus productos de acuerdo con las directrices establecidas por la Organización Mundial de la Salud y los Centros para el Control de Enfermedades.

CONECTAR LOS AUDÍFONOS POR LIGHTSPEED

Conecta a tu PC, Mac, PlayStation 5 o 4 con tecnología inalámbrica LIGHTSPEED

– Inserta el receptor en el puerto USB de tu dispositivo.

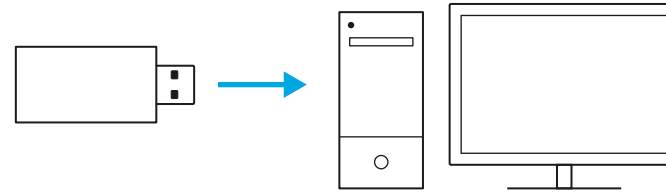

– Mantén presionado el botón de encendido un mínimo de 1,5 segundos.

– El LED se vuelve **cian** una vez conectado.

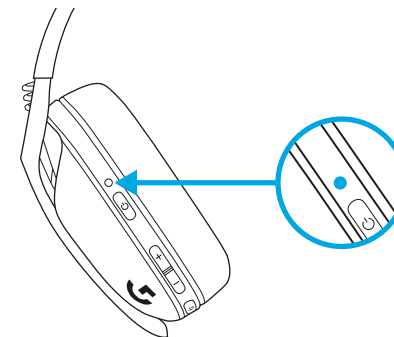
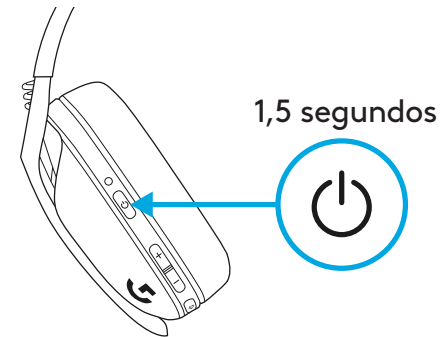

CÓMO CONECTAR LOS G435 SE POR *BLUETOOTH*

- Presiona 3 segundos o más los botones de encendido + silencio.

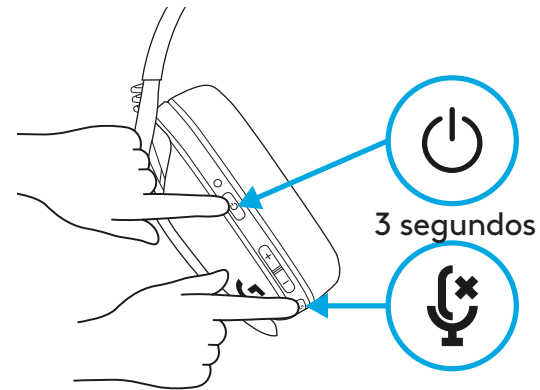

- El LED emitirá destellos **azules** al entrar en modo de emparejamiento.

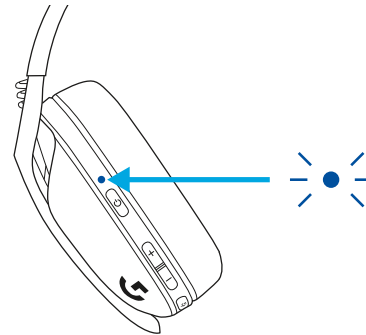

- Busca G435 SE en la lista *bluetooth* de tu dispositivo y conecta.
- Nota: Los audífonos G435 SE pueden conectarse a un único dispositivo *bluetooth* a la vez.

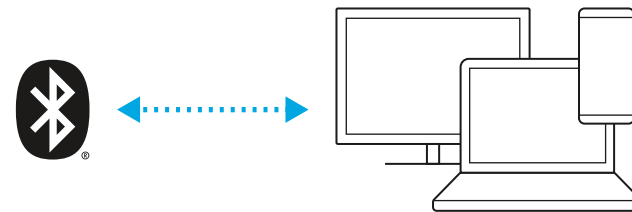

CÓMO CAMBIAR EL MODO DE CONEXIÓN ENTRE LIGHTSPEED Y *BLUETOOTH* EN LOS G435 SE

- Presiona 3 segundos o más el botón de silencio.

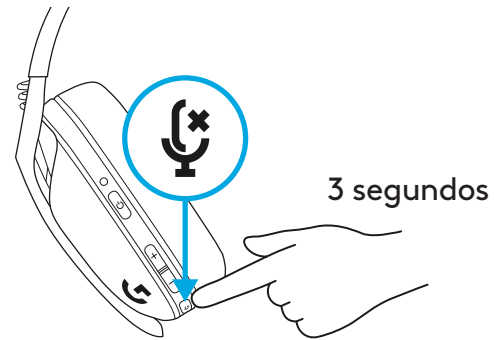

- Cambia a LIGHTSPEED, el LED se iluminará en **cian** por 5 segundos.

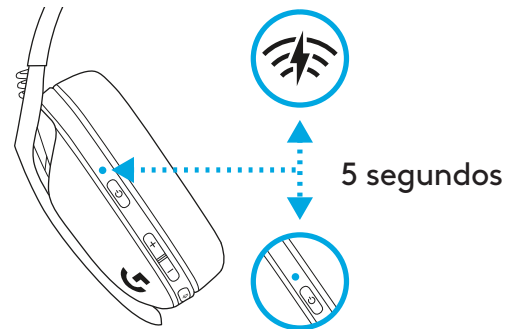

- Cambia a *Bluetooth*, el LED se iluminará en **azul** por 5 segundos.

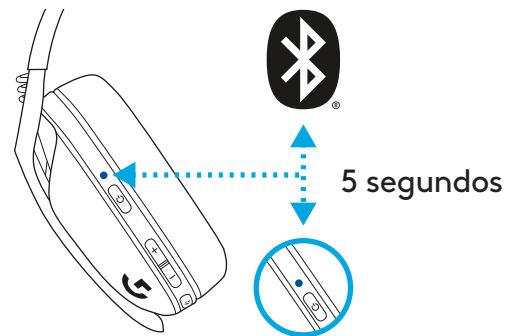

CÓMO ENCENDER Y APAGAR LOS G435 SE

ENCENDIDO

- Presiona el botón de encendido por 1,5 segundos cuando los audífonos estén apagados.

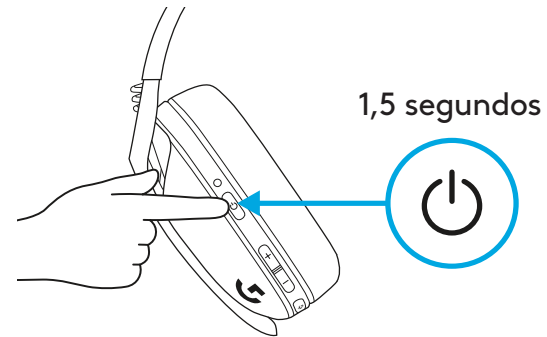

APAGADO

- Presiona el botón de encendido por 3 segundos cuando los audífonos estén encendidos.

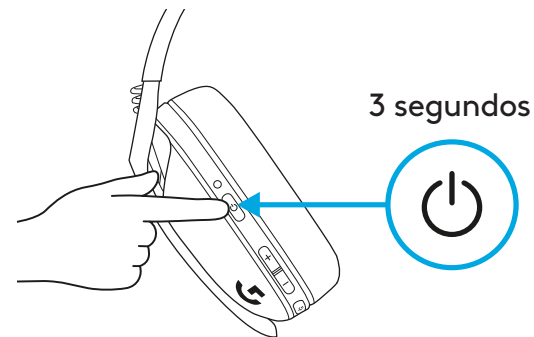

Apagado automático

- Los G435 SE se apagan automáticamente después de 30 minutos de inactividad.

CÓMO ALTERNAR SILENCIAR/REACTIVAR SONIDO Y VOLUMEN MÁXIMO EN LOS G435 SE

SILENCIAR/REACTIVAR micrófono

- Pulsación breve del botón de silencio.

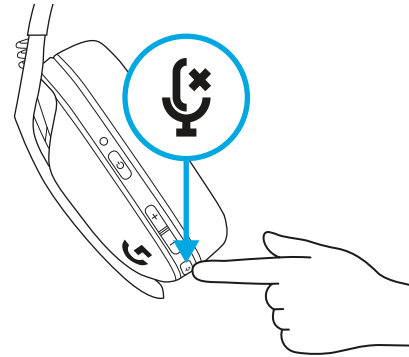

Establecer volumen máximo

- Establecer a 100 dB
 - Presiona 3 segundos o más el botón de silencio + SUBIR volumen.
 - El LED emitirá destellos **naranja** 3 veces.

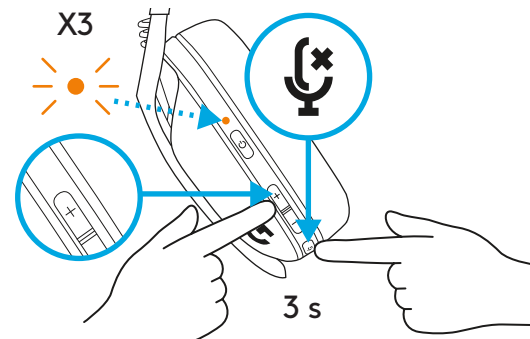

- Establecer a 85 dB
 - Presiona 3 segundos o más el botón de silencio + BAJAR volumen.
 - El LED se volverá **naranja** por 5 segundos.

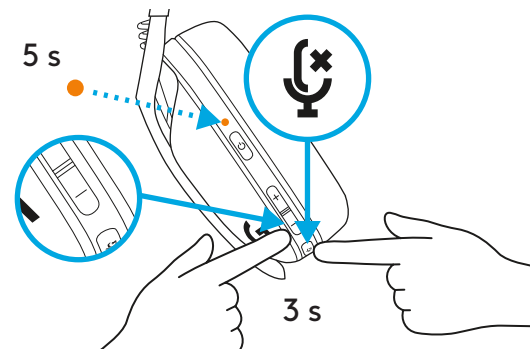

COMPROBAR EL NIVEL DE BATERÍA DE LOS G435 SE

- Una sola pulsación del botón de encendido, con los audífonos encendidos

- El LED aparecerá **verde** por 5 segundos, lo que significa que la batería está entre el 31% y el 100%.

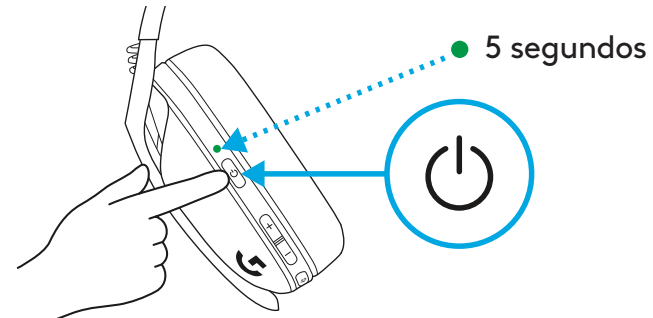

- El LED aparecerá **rojo** por 5 segundos, lo que significa que la batería está entre el 15% y el 30%.

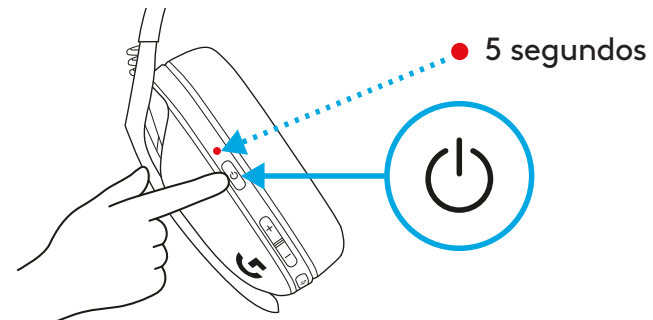

- El LED emitirá destellos **rojos** por 5 segundos, lo que significa que el nivel de batería es <15%.

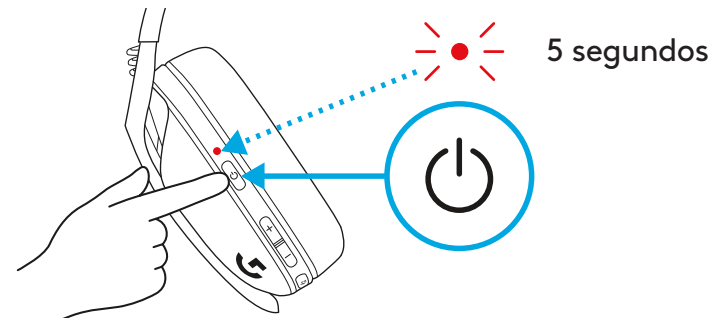

CONFIGURAR EL TONO LATERAL DE LOS G435 SE

El tono lateral te permite oír tu voz mientras te comunicas con otras personas. Refleja la experiencia de hablar por teléfono y te permite ajustar tu volumen de habla a un nivel adecuado.

- Activar el tono lateral
 - Presiona dos veces el botón de silencio y el LED emitirá dos destellos en **naranja**.

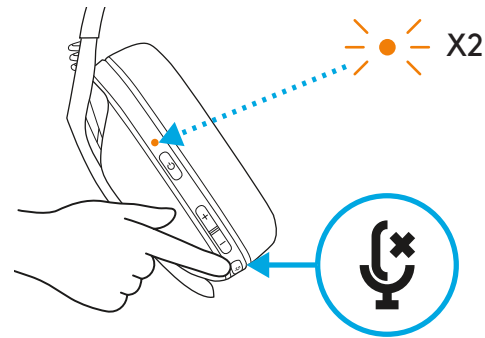

- Desactivar el tono lateral
 - Presiona dos veces el botón de silencio y el LED emitirá un destello en **naranja**.

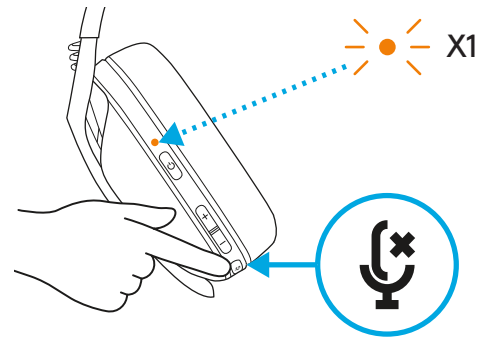

- Ajustar el tono lateral
 - SUBIR = Una sola pulsación del botón de silencio + SUBIR volumen.

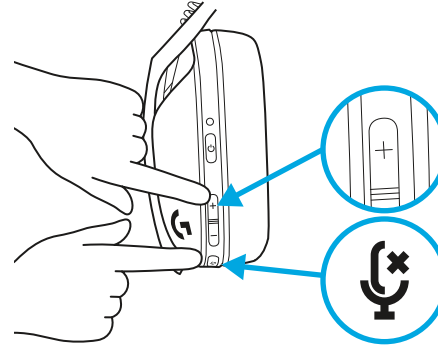

- BAJAR = Una sola pulsación del botón de silencio + BAJAR volumen.

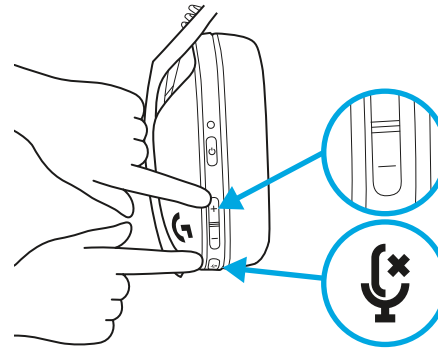

PIEZAS DE REPUESTO

- Almohadillas
- Receptor USB inalámbrico
- Cable de carga

RECICLAJE

Aconsejamos encarecidamente la reventa o donación de productos que aún funcionen. En caso de desecharlos, las baterías y los equipos eléctricos y electrónicos no se deben arrojar junto con la basura doméstica. Siempre que sea posible, deben separarse y llevarse a un punto de recogida pertinente para permitir el reciclaje y evitar posibles impactos en el medio ambiente y la salud humana. Para obtener más información, póngase en contacto con las autoridades locales o el lugar de compra, o visite www.logitech.com/recycling

¿PREGUNTAS?

logitechG.com/support/G435SE

EXTRACCIÓN DE LA BATERÍA

1

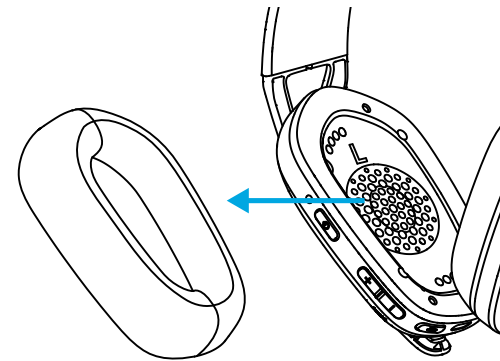

2

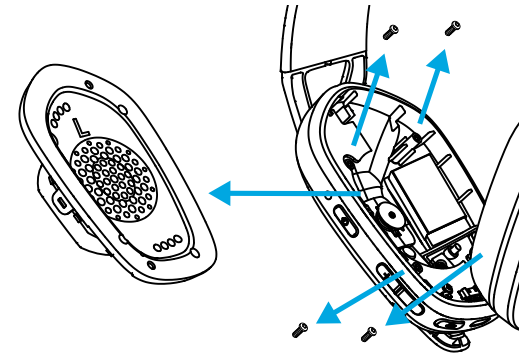

3

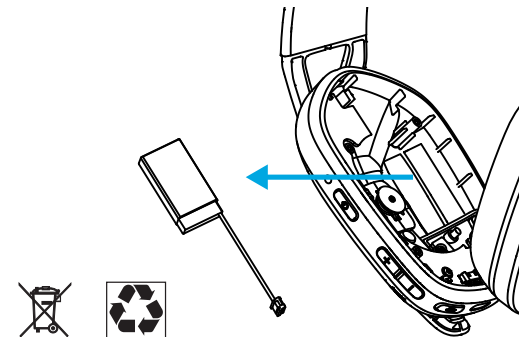

LIMPANDO O LOGITECH G435 SE

Caso seu dispositivo Logitech G435 SE precise de limpeza, temos algumas recomendações.

Antes de começar

- Não lave o fone acolchoado na máquina de lavar
- Não seque seus fones acolchoados em uma máquina de secar roupa
- Não coloque líquidos de limpeza diretamente no fone acolchoado e arco de cabeça.
- Não use alvejante, acetona/removedor de esmalte, solventes fortes ou abrasivos, pois isso pode afetar a condição da superfície do tecido de poliéster e causar descoloração.
- Ao usar sprays de limpeza, borrife o pano e faça a limpeza, não borrife diretamente o produto.

Limpeza do seu G435 SE

- Para limpar o headset, use água comum da torneira para umedecer levemente um pano limpo, macio e sem fiapos e limpe suavemente o arco de cabeça e o fone acolchoado.
- Para manchas mais difíceis, você pode usar adicionalmente uma pequena quantidade de sabão no pano macio umedecido levemente e esfregar suavemente as áreas manchadas. Enxágue bem a superfície usando o mesmo pano umedecido. Repita até que todos os vestígios de sabão tenham desaparecido.
- Você também pode usar toalhinhas desinfetantes sem fragrância e toalhinha úmidas antibacterianas sem fragrância.
- Deixe secar em temperatura ambiente.

A Logitech incentiva os usuários a higienizar adequadamente seus produtos de acordo com as diretrizes da Organização Mundial da Saúde e do Centro de Controle de Doenças.

CONECTANDO SEU HEADSET USANDO O LIGHTSPEED

Conecte ao seu PC, Mac, PlayStation 5 ou 4 com a tecnologia sem fio LIGHTSPEED

– Insira o receptor na porta USB do seu dispositivo.

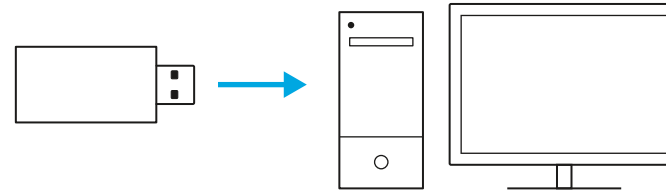

- Pressione o botão liga/desliga por no mínimo 1.5 segundo.
- O LED se torna **ciano** uma vez conectado.

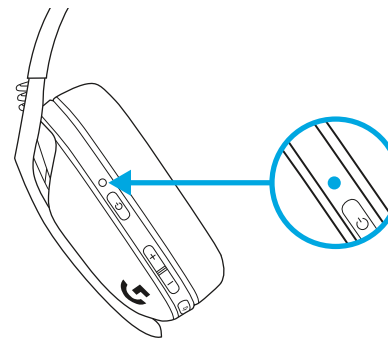
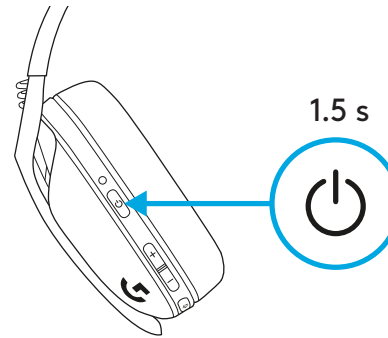

PARA CONECTAR SEU G435 SE USANDO BLUETOOTH:

- Pressione os botões Energia+Sem áudio por 3 segundos ou mais.

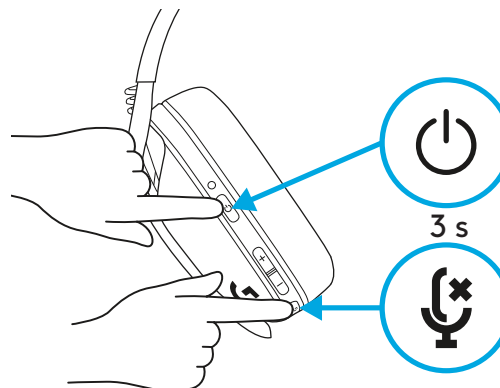

- O LED piscará em azul ao entrar em modo de emparelhamento.

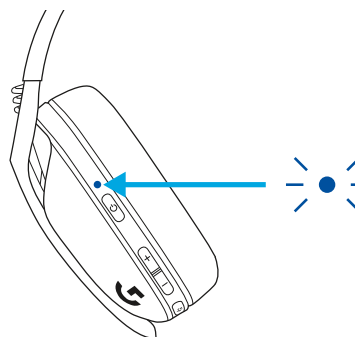

- Procure G435 SE sob a lista *bluetooth* de seu dispositivo e conecte-se.
- Observação: G435 SE pode se conectar a um único dispositivo *Bluetooth* de cada vez.

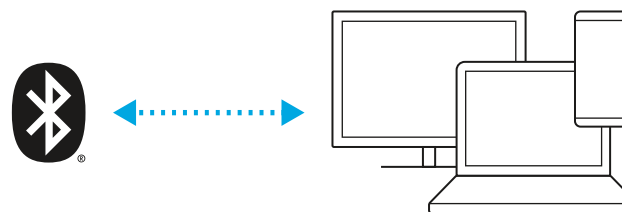

COMO MUDAR O MODO DE CONEXÃO ENTRE LIGHTSPEED E *BLUETOOTH* NO G435 SE

- Pressione o botão Sem áudio por 3 segundos ou mais.

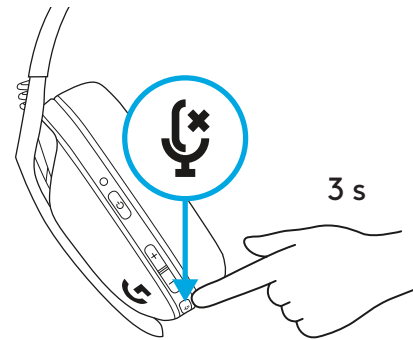

- Alterne para LIGHTSPEED, o LED acenderá em **ciano** durante 5 segundos.

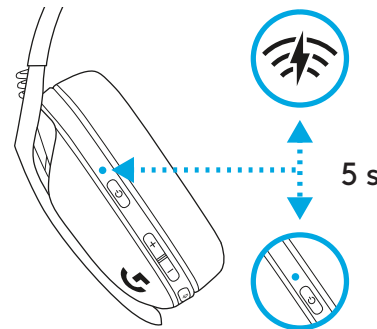

- Alterne para *Bluetooth*, o LED acenderá **azul** durante 5 segundos.

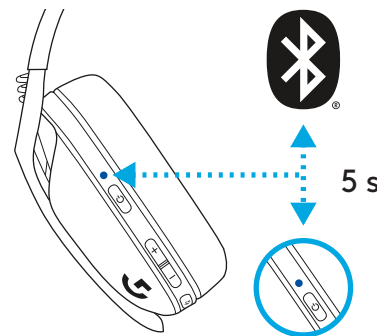

COMO LIGAR E DESLIGAR SEU G435 SE

LIGAR

- Pressione o botão Liga/desliga por 1,5 segundos quando o fone de ouvido estiver DESLIGADO.

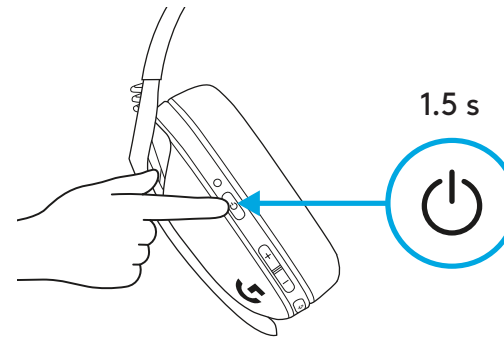

Desligar

- Pressione o botão Liga/desliga por 3 segundos quando o headset estiver DESLIGADO.

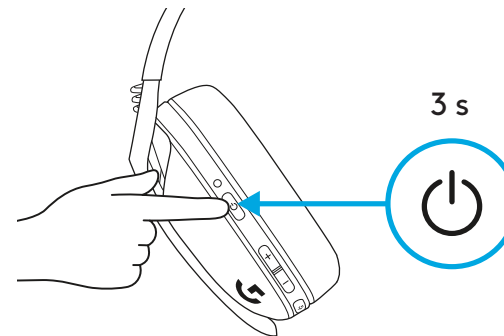

Desligamento automático

- G435 SE se desliga automaticamente após 30 minutos de inatividade.

COMO ALTERNAR COM/SEM ÁUDIO E VOLUME MÁXIMO EM SEU G435 SE

SILENCIAR/ATIVAR som do microfone

- Pressione rapidamente o botão sem áudio

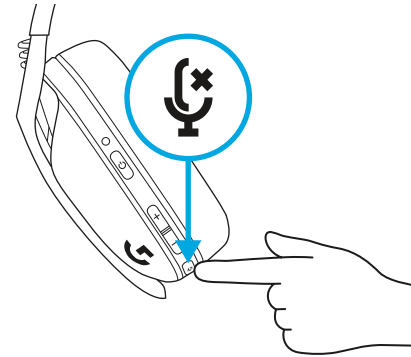

Definir Volume máximo

- Definir como 100 dB
 - Pressione o botão Sem áudio + Aumentar volume por três ou mais segundos.
 - O LED piscará em **laranja** três vezes.

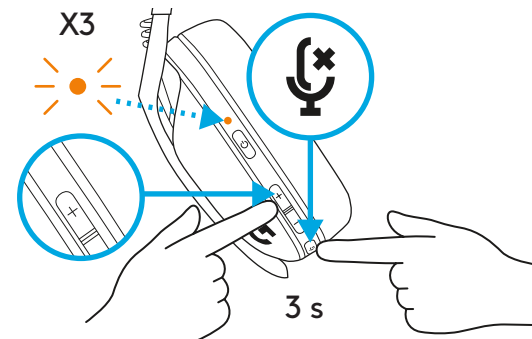

- Definir como 85 dB
 - Pressione o botão Sem áudio + Diminuir volume por três segundos ou mais.
 - O LED ficará sólido em **laranja** durante 5 segundos.

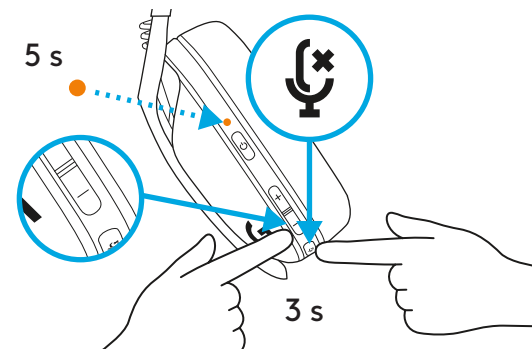

VERIFIQUE O NÍVEL DA BATERIA DE SEU G435 SE

– Botão Liga/desliga, quando o fone de ouvido está ligado

– O LED mostrará **verde** durante 5 segundos, o que significa Bateria está entre 31% a 100%.

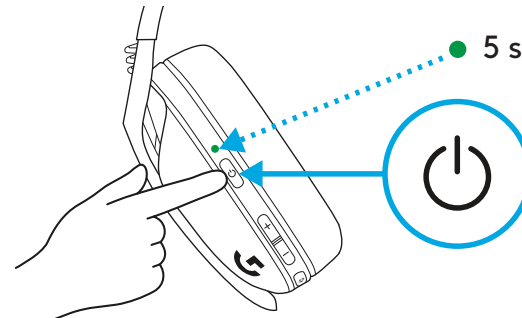

– O LED ficará **vermelho** durante 5 segundos, o que significa Bateria está entre 15% a 30%.

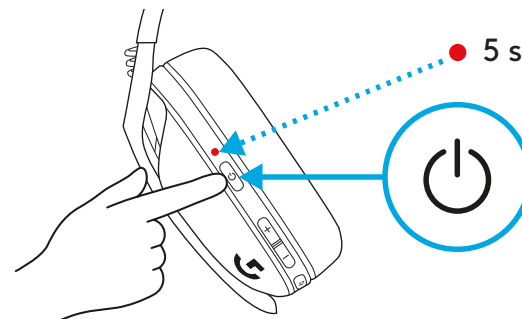

– O LED piscará em **vermelho** durante 5 segundos, o que significa que o nível da bateria é <15%.

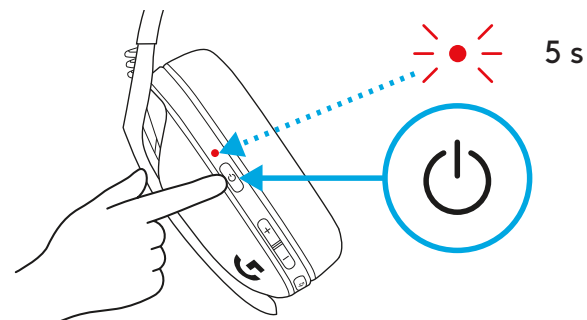

USE O SIDETONE EM SEU G435 SE

Sidetone permite que você ouça sua voz enquanto se comunica com outras pessoas. Ele reflete a experiência de falar ao telefone e permite que você ajuste seu volume de fala a um nível adequado.

– Habilitar Sidetone

- Aperte duas vezes o botão Sem áudio e o LED piscará duas vezes em **laranja**.

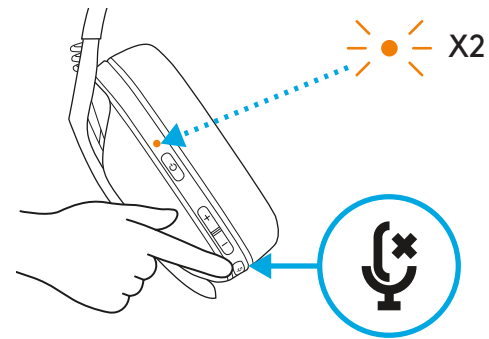

– Desabilitar Sidetone

- Aperte duas vezes o botão Sem áudio e o LED piscará uma vez em **laranja**.

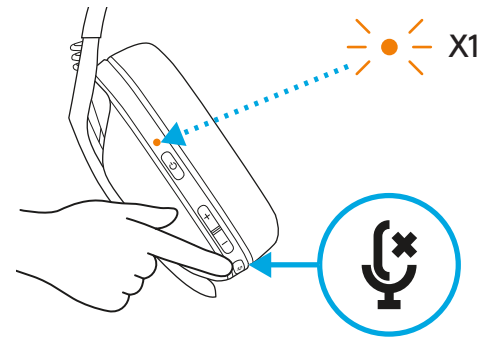

- Ajustar Sidetone

- Aumentar = Pressione uma vez o botão sem áudio + Aumentar volume.

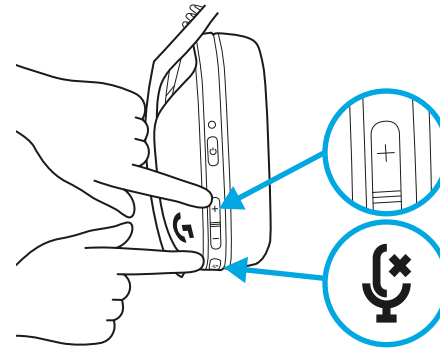

- Diminuir = Pressione uma vez o botão sem áudio + Diminuir volume.

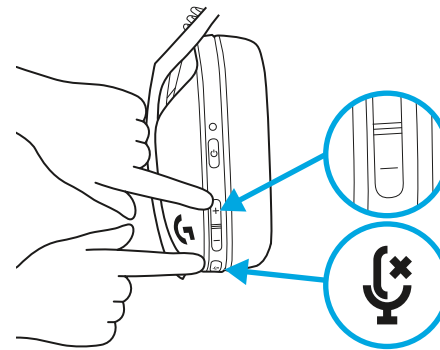

PEÇAS SOBRESSALENTES

- Fones acolchoados
- Receptor USB sem fio
- Cabo de carregamento

RECICLAGEM

Incentivamos você a revender ou doar produtos de trabalho. Caso contrário, baterias, equipamentos eletrônicos e elétricos não devem ser descartados com o lixo doméstico. Sempre que possível, eles devem ser separados e levados a um ponto de coleta apropriado para permitir a reciclagem e evitar possíveis impactos ao meio ambiente e à saúde humana. Para obter mais informações, entre em contato com as autoridades locais ou o local de compra, ou visite www.logitech.com/recycling

ALGUMA DÚVIDA?

logitechG.com/support/G435SE

REMOÇÃO DA BATERIA

1

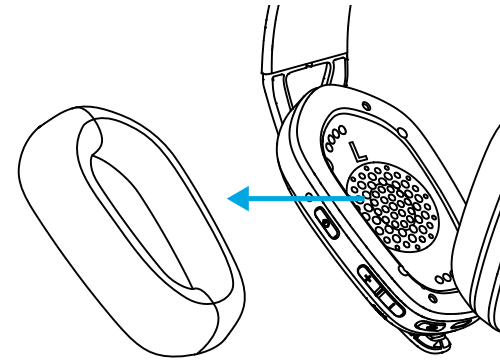

2

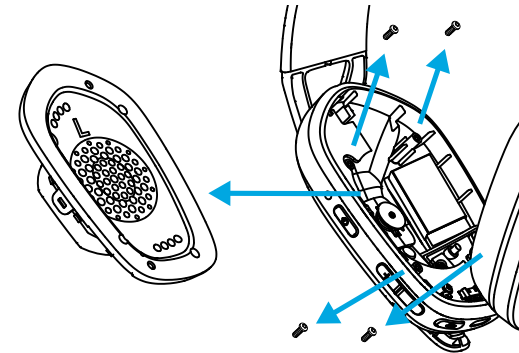

3

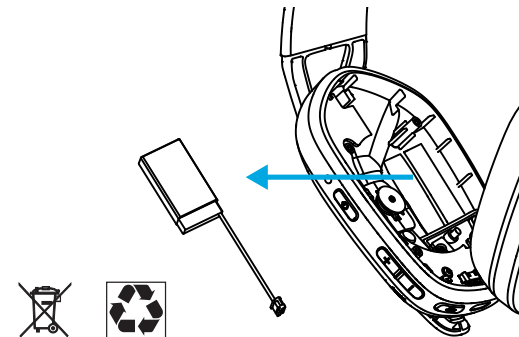



© 2022 Logitech. Logitech, Logitech G and the Logitech and Logitech G logos are trademarks or registered trademarks of Logitech Europe S.A. and/or its affiliates in the U.S. and other countries. All other trademarks are the property of their respective owners. Logitech assumes no responsibility for any errors that may appear in this manual. Information contained herein is subject to change without notice.

©2022 Logitech. Logitech, Logitech G, Logi et leurs logos respectifs sont des marques commerciales ou déposées de Logitech Europe S.A. et/ou de ses sociétés affiliées aux États-Unis et dans d'autres pays. Toutes les autres marques sont la propriété exclusive de leurs détenteurs respectifs. Logitech décline toute responsabilité en cas d'erreurs susceptibles de s'être glissées dans le présent manuel. Les informations énoncées dans ce document peuvent faire l'objet de modifications sans préavis.

WEB-621-002175 002