

# H390

## Setup Guide

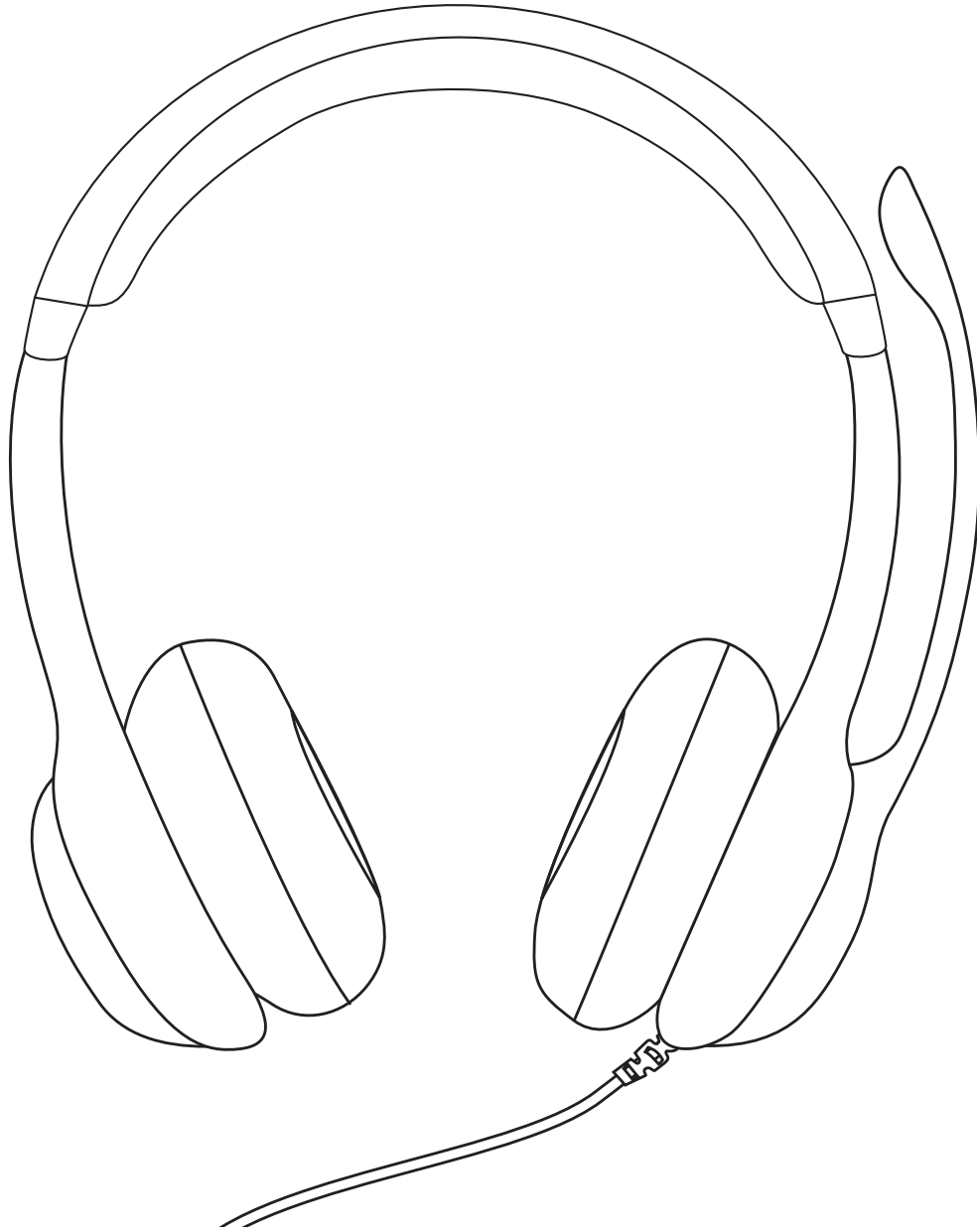

logitech®

## CONTENTS

English . . . . .	3	Česká verze . . . . .	48
Deutsch . . . . .	6	Slovenčina . . . . .	51
Français . . . . .	9	Українська . . . . .	54
Italiano . . . . .	12	Eesti . . . . .	57
Español . . . . .	15	Latviski . . . . .	60
Português . . . . .	18	Lietuvių . . . . .	63
Nederlands . . . . .	21	Български . . . . .	66
Svenska . . . . .	24	Hrvatski . . . . .	69
Dansk . . . . .	27	Srpski . . . . .	72
Norsk . . . . .	30	Slovenščina . . . . .	75
Suomi . . . . .	33	Română . . . . .	78
Ελληνικά . . . . .	36	Türkçe . . . . .	81
По-русски . . . . .	39	84 . . . . .	العربية
Po polsku . . . . .	42	87 . . . . .	עברית
Magyar . . . . .	45		

# KNOW YOUR PRODUCT

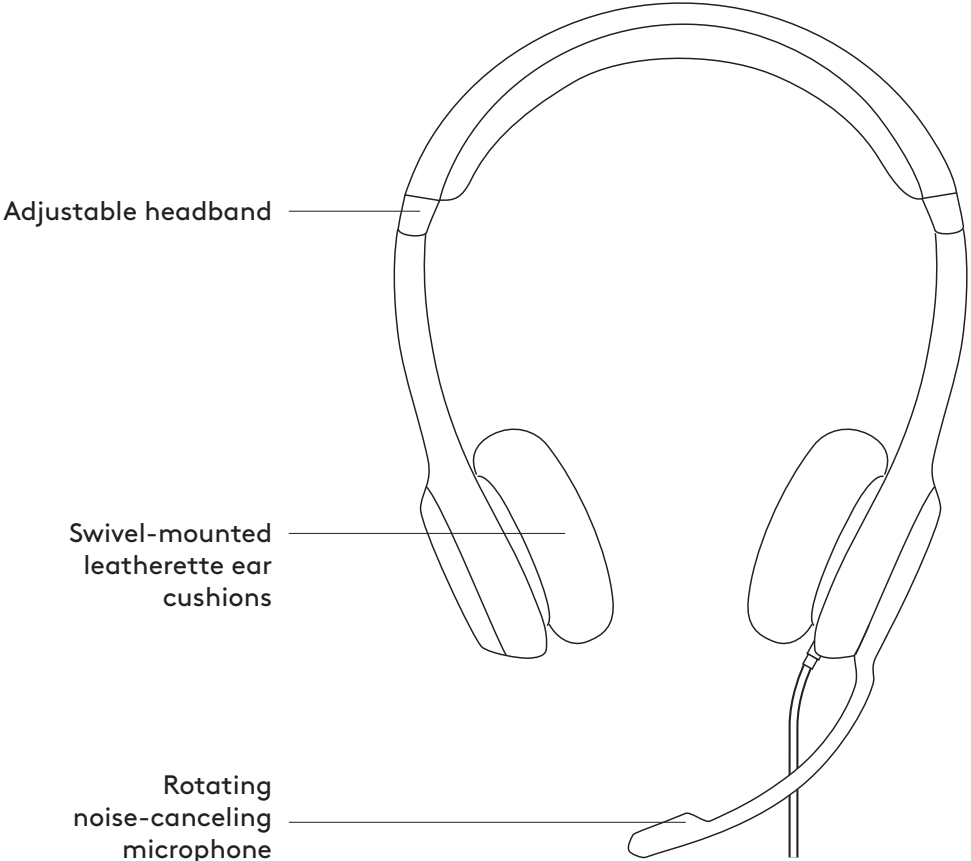

# IN-LINE CONTROLLER

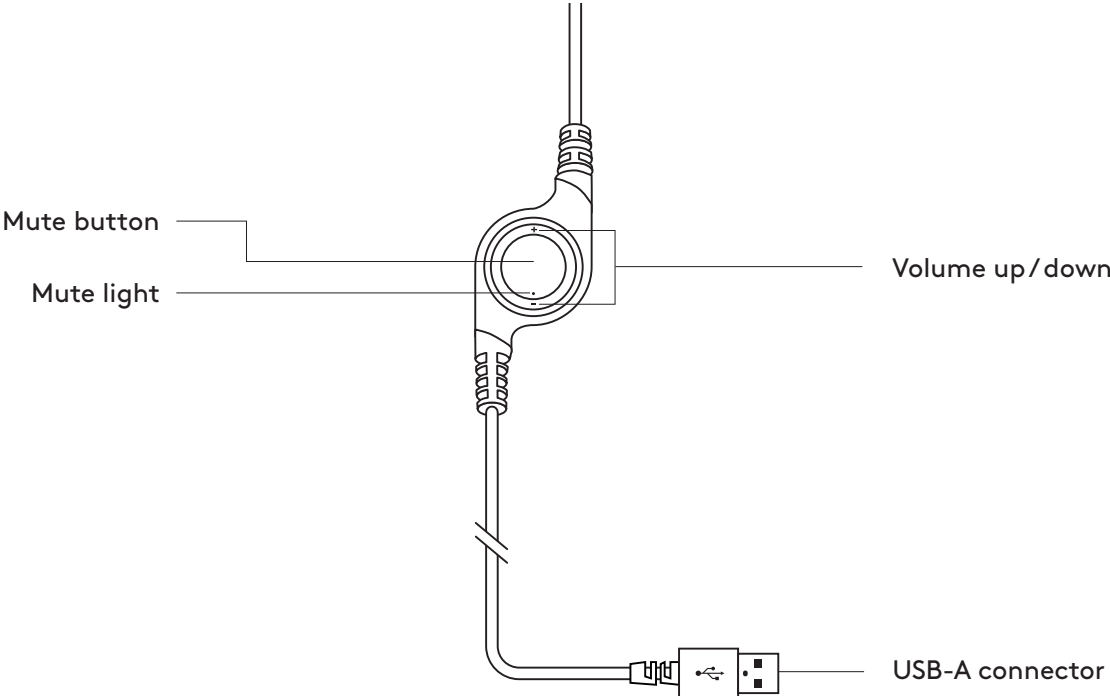

## CONNECTING THE HEADSET

Plug the USB-A connector into the computer USB port.

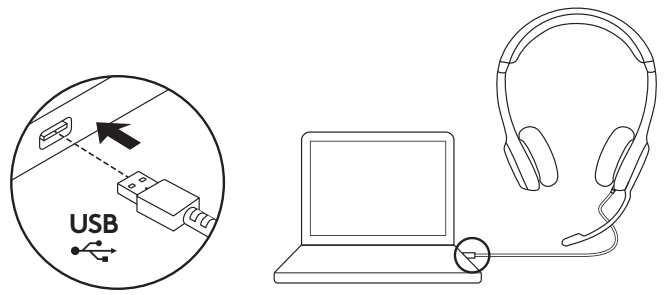

## HEADSET FIT

1. To adjust headset size, move the headband up and down until it fits comfortably.
2. Move the microphone boom up or down until it is level with your mouth for better voice capture.
3. Boom can be tucked out of the way when not being used.

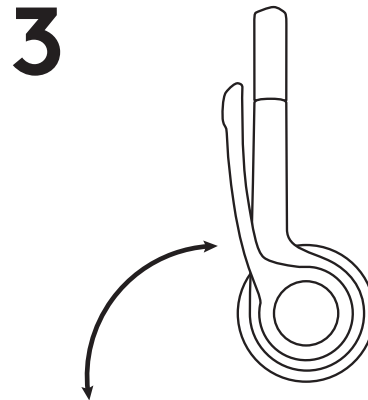
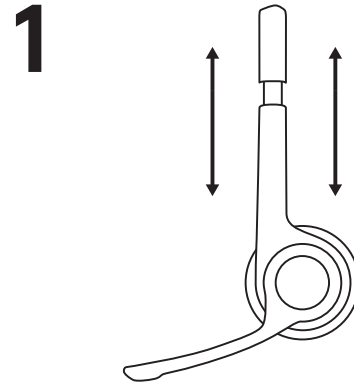



# CONTROLS

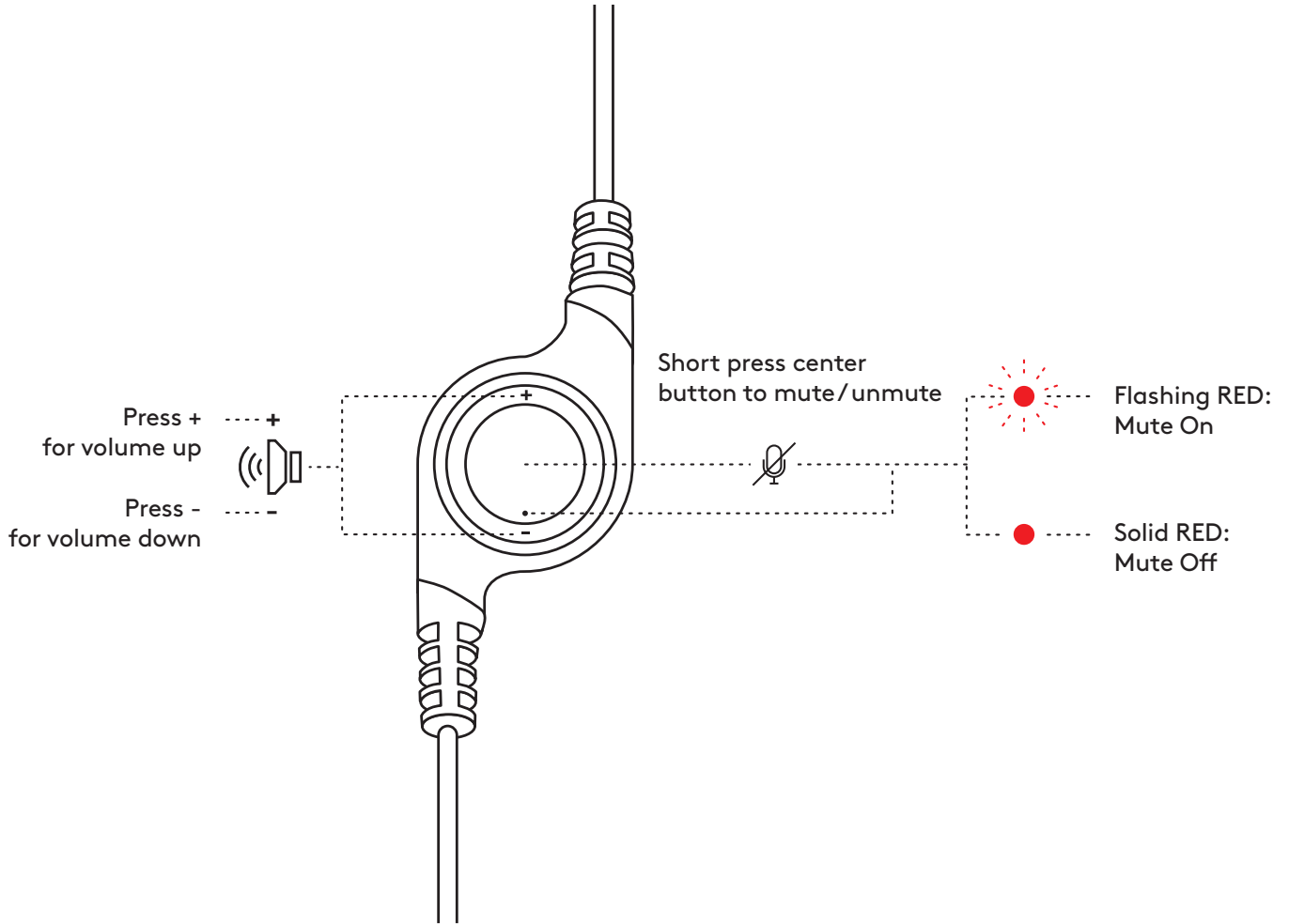

[www.logitech.com/support/H390](http://www.logitech.com/support/H390)

## PRODUKT AUF EINEN BLICK

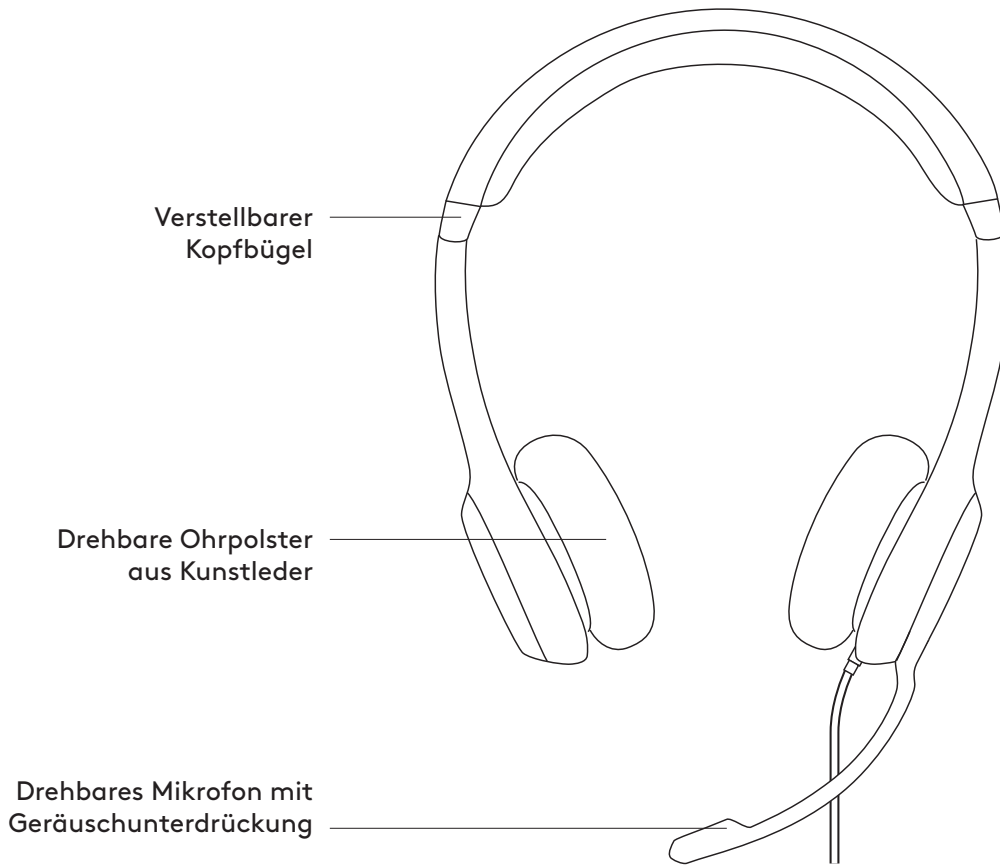

## BEDIENELEMENTE AM KABEL

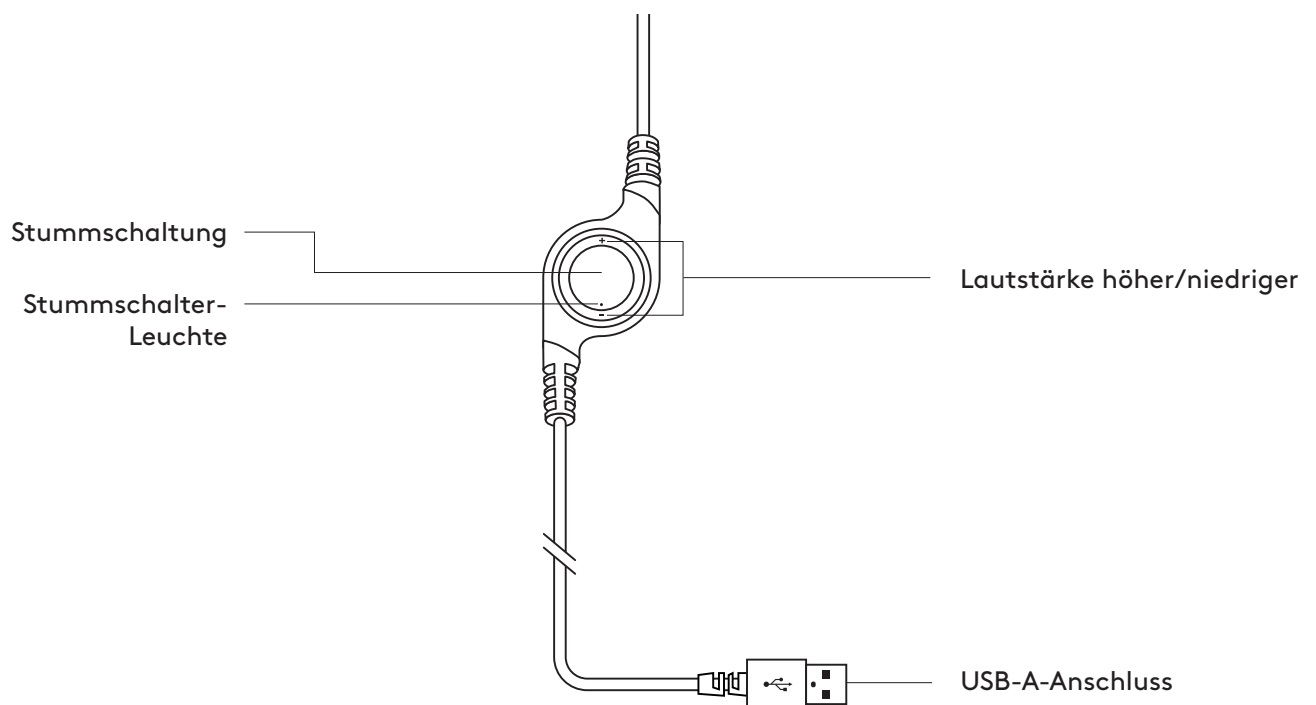

## VERBINDEN DES HEADSETS

Stecken Sie den Unifying Empfänger an einem USB-Anschluss am Computer ein.

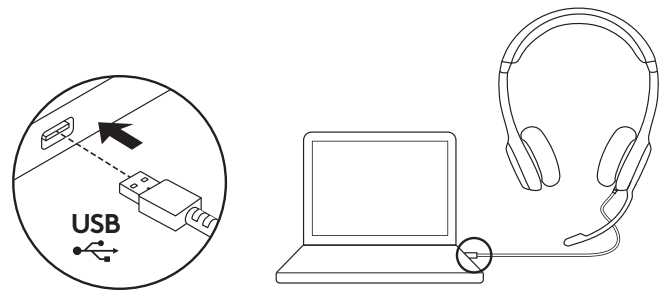

## HEADSET-ANPASSUNG

1. Bewegen Sie zum Anpassen der Größe des Headsets den Kopfbügel auf und ab, bis es bequem sitzt.
2. Passen Sie den Mikrofonbügel so an, dass er sich auf Höhe Ihres Mundes befindet, um eine optimale Spracherfassung zu erreichen.
3. Das Bügelmikrofon lässt sich nach oben wegklappen, wenn Sie es nicht benötigen.

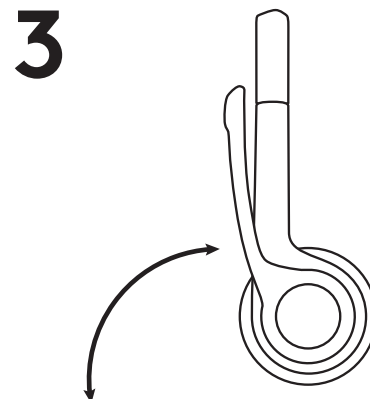
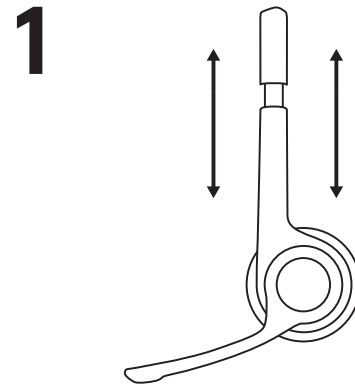

## BEDIENELEMENTE

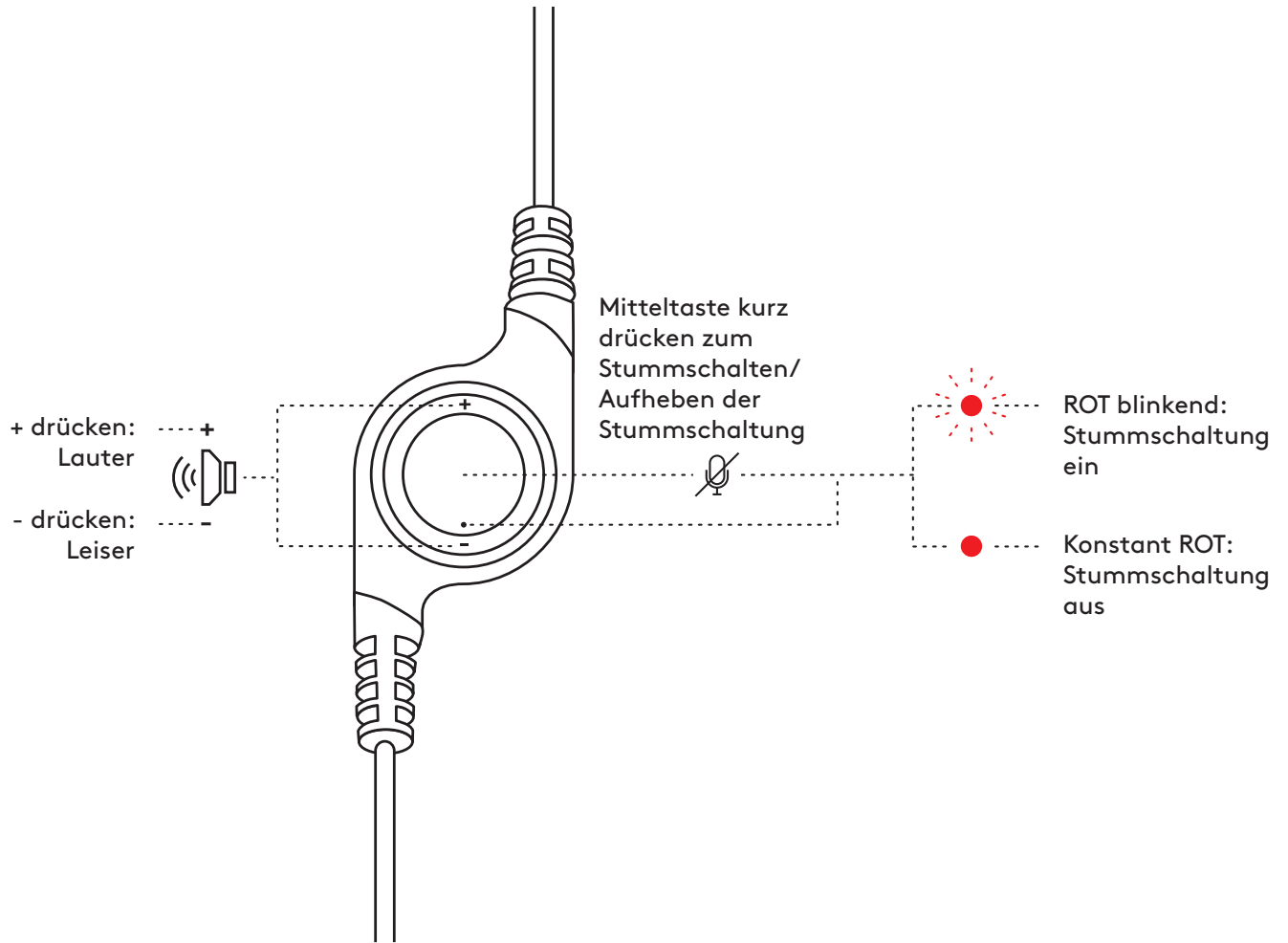

[www.logitech.com/support/H390](http://www.logitech.com/support/H390)

## PRÉSENTATION DU PRODUIT

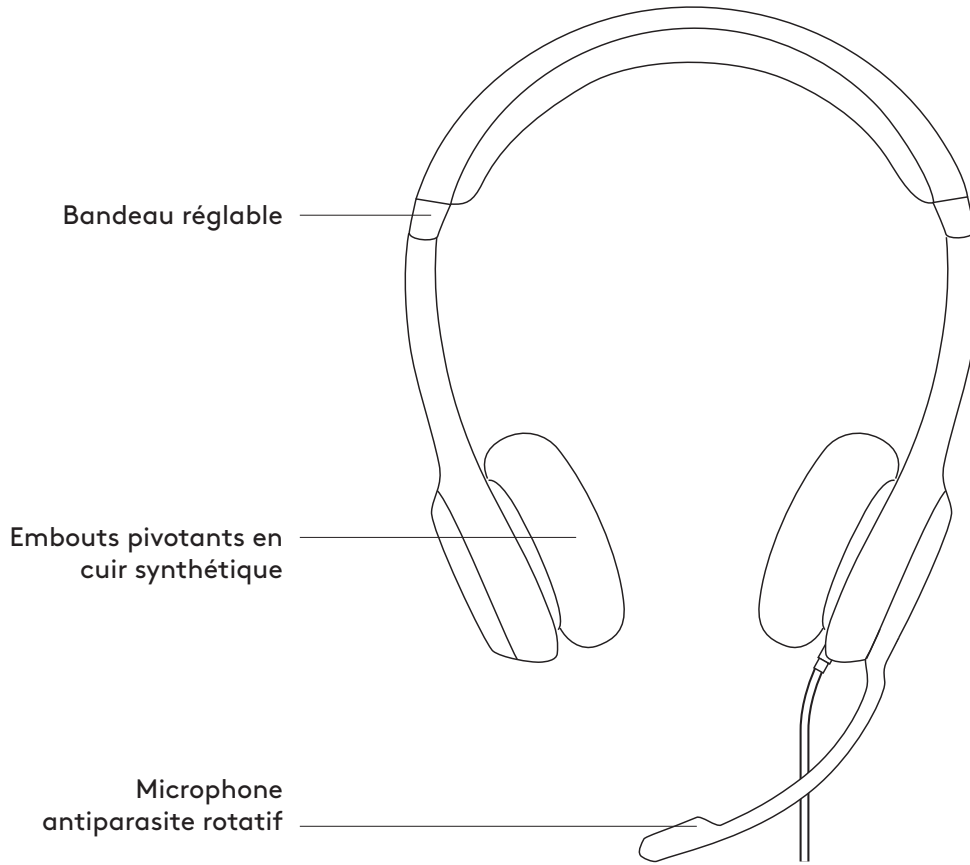

## CONTRÔLEUR INTÉGRÉ

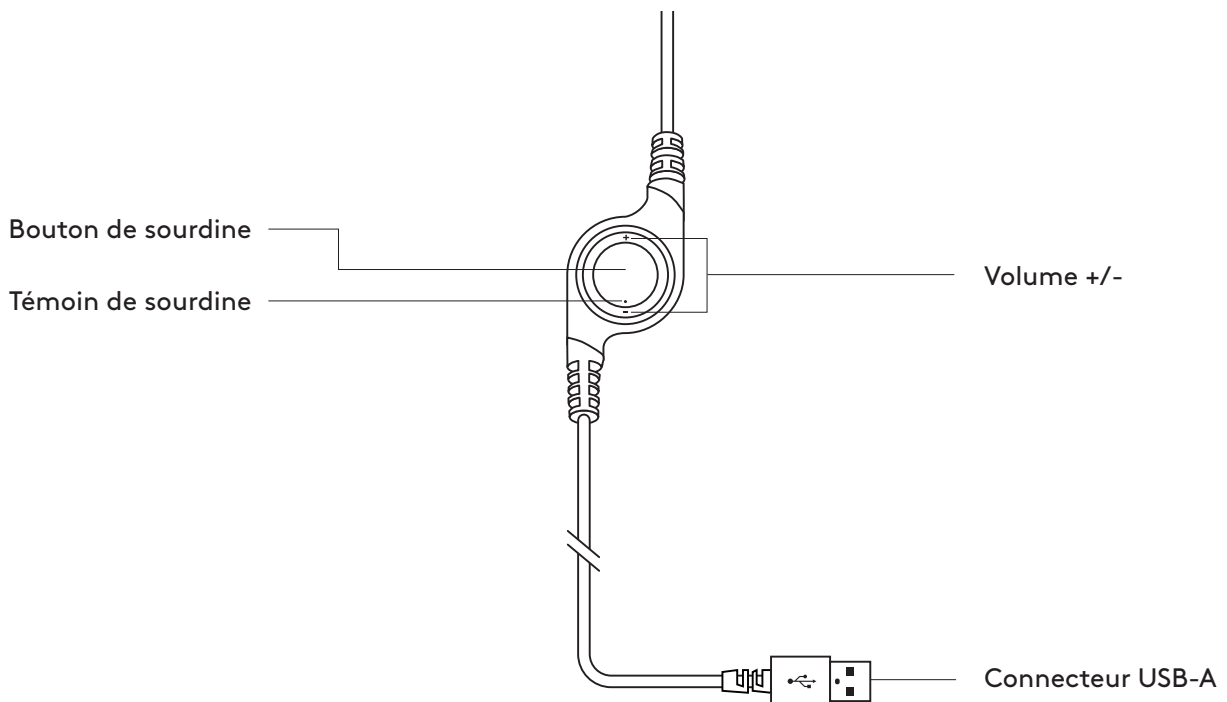

## BRANCHEMENT DU CASQUE

Branchez le connecteur USB-A sur un port USB de l'ordinateur.

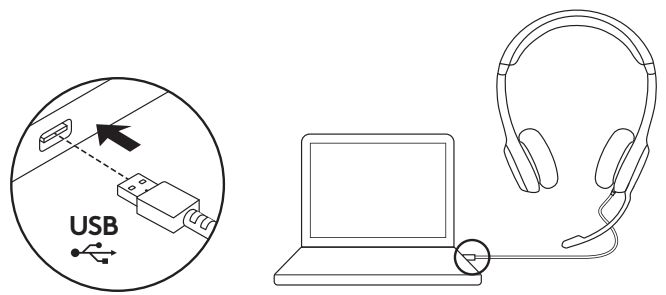

## AJUSTEMENT DU CASQUE

1. Pour ajuster la taille du casque, déplacez le bandeau de haut en bas jusqu'à ce qu'il soit confortable.
2. Déplacez la tige du microphone vers le haut ou vers le bas jusqu'à ce qu'elle soit au niveau de votre bouche pour une meilleure capture de la voix.
3. La tige peut être rabattue lorsque vous ne l'utilisez pas.

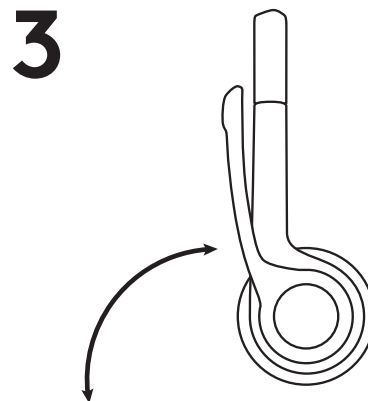
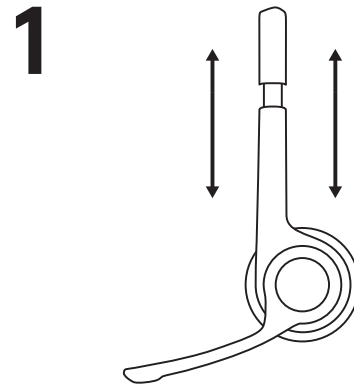

## COMMANDES

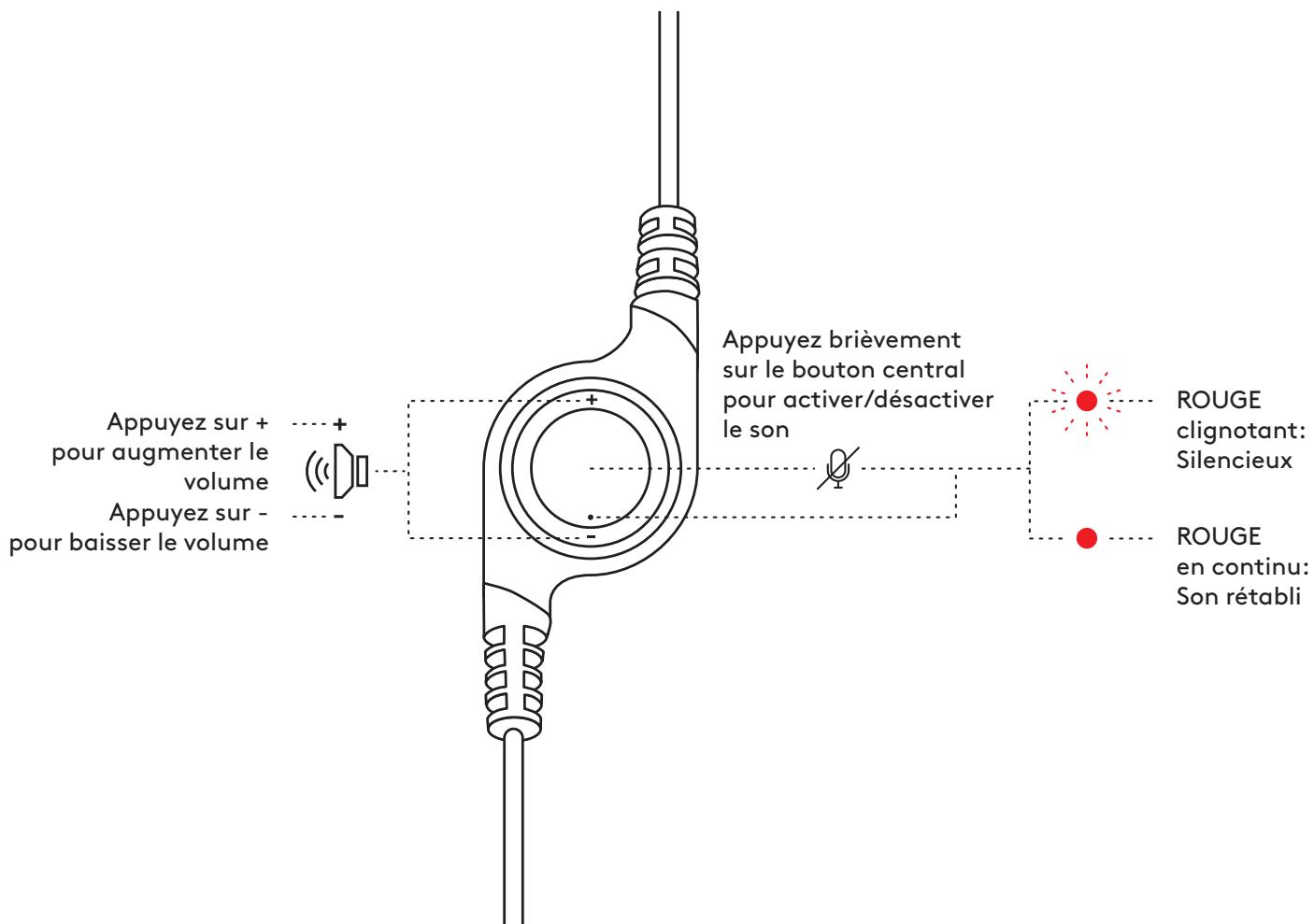

[www.logitech.com/support/H390](http://www.logitech.com/support/H390)

## PANORAMICA DEL PRODOTTO

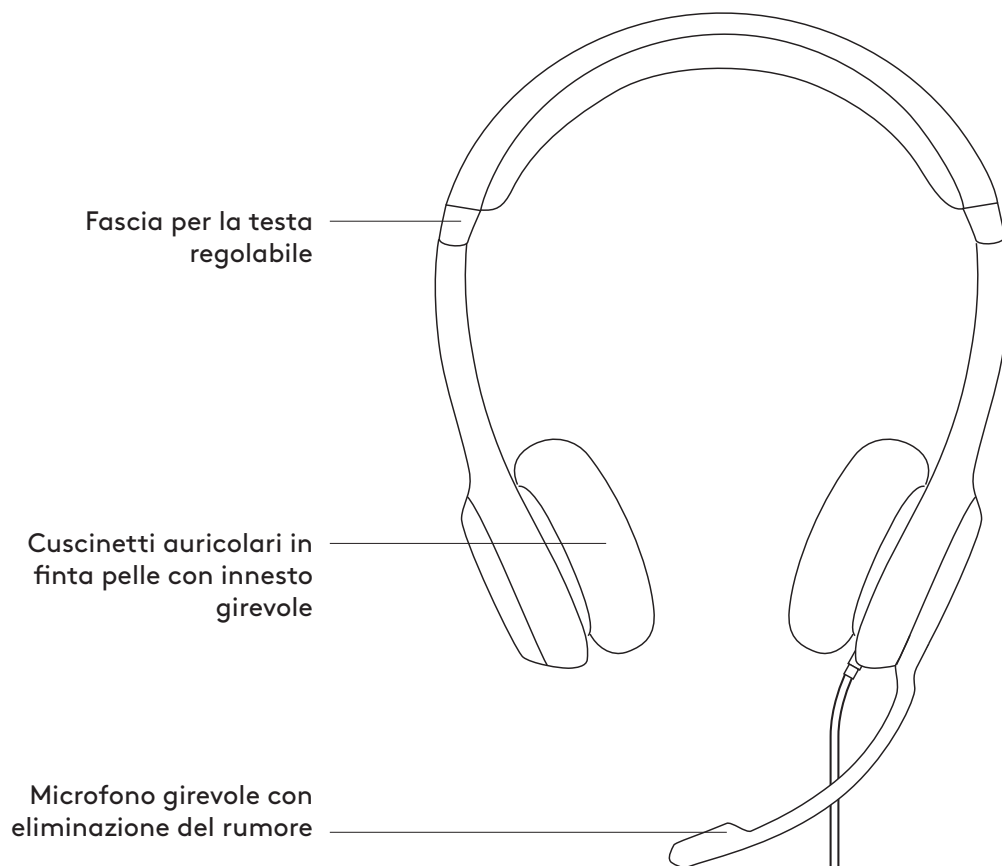

## CONTROLLI SUL CAVO

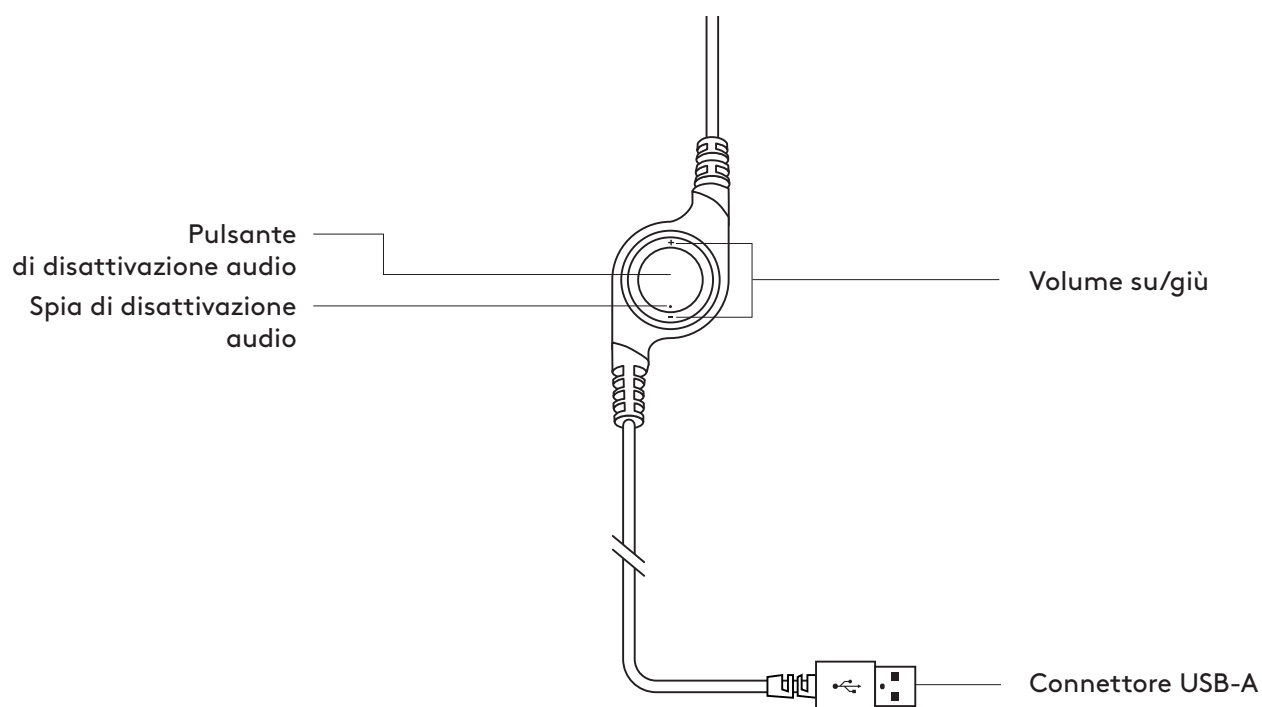



## CONNESSIONE DELLA CUFFIA CON MICROFONO

Collegare il connettore USB-A alla porta USB del computer.

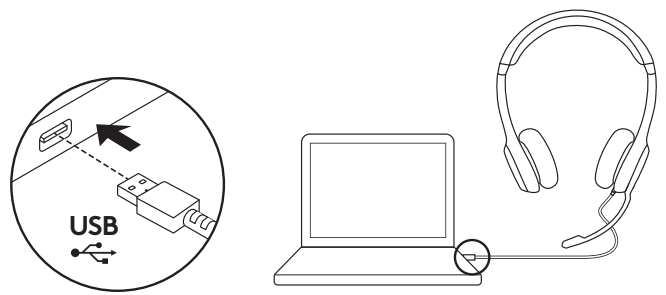

## ADATTAMENTO DELLA CUFFIA CON MICROFONO

1. Per adattare le dimensioni della cuffia con microfono, sposta la fascia per la testa in alto e in basso finché non si posiziona comodamente.
2. Sposta il microfono verso l'alto o verso il basso fino a portarlo all'altezza della bocca per una migliore acquisizione della voce.
3. Sposta il microfono fuori portata quando non lo utilizzi.

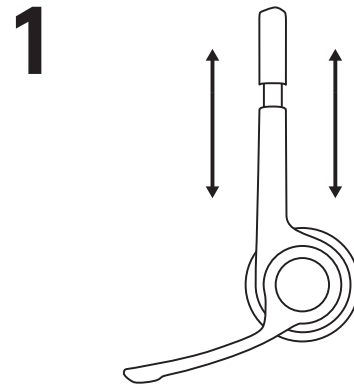

**20**

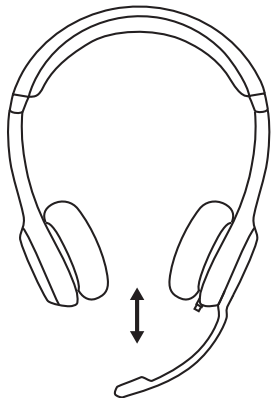

**3**

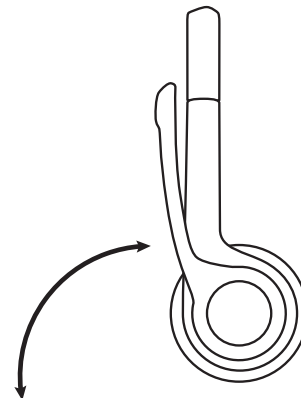

## CONTROLLI

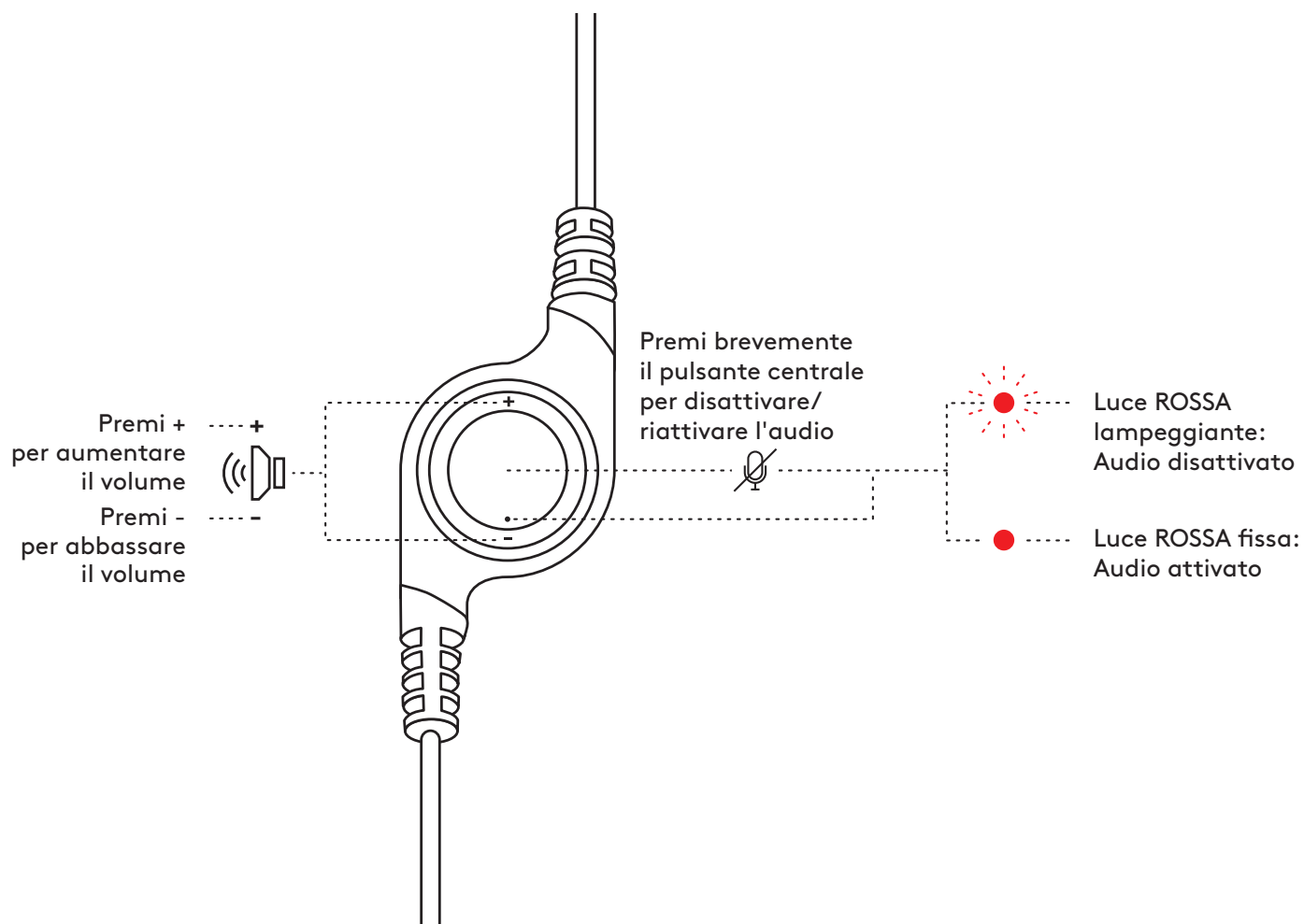

[www.logitech.com/support/H390](http://www.logitech.com/support/H390)

## COMPONENTES DEL PRODUCTO

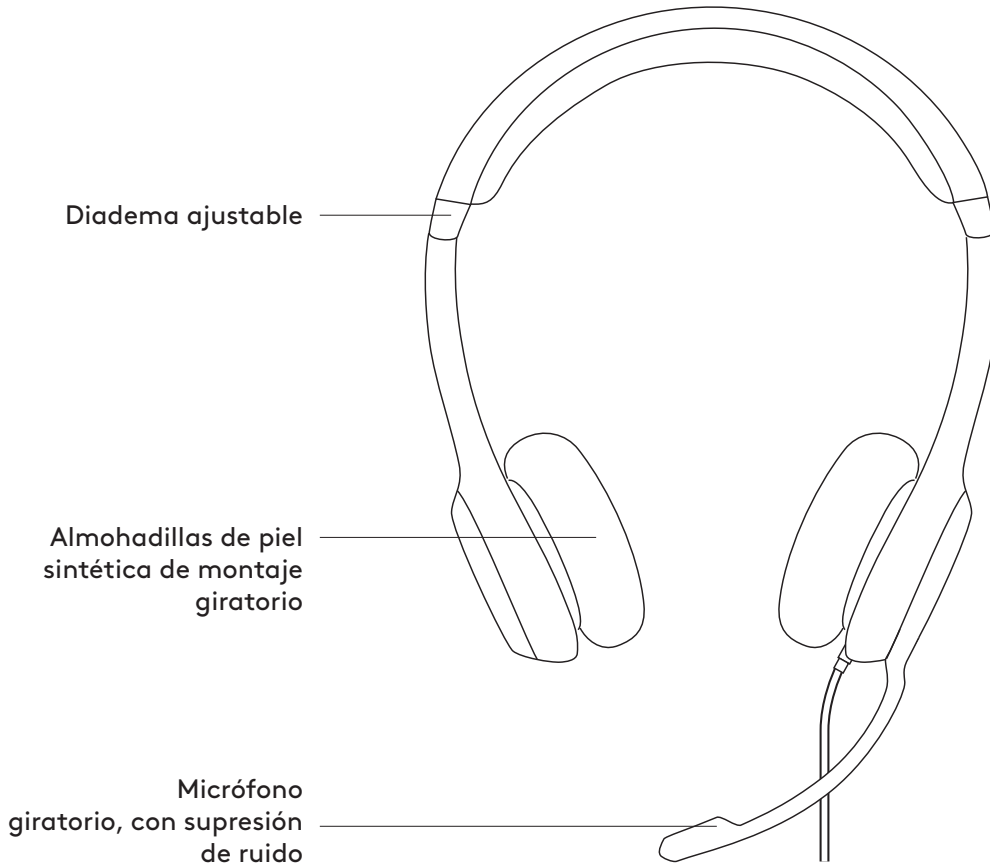

## CONTROLADOR INTEGRADO EN EL CABLE

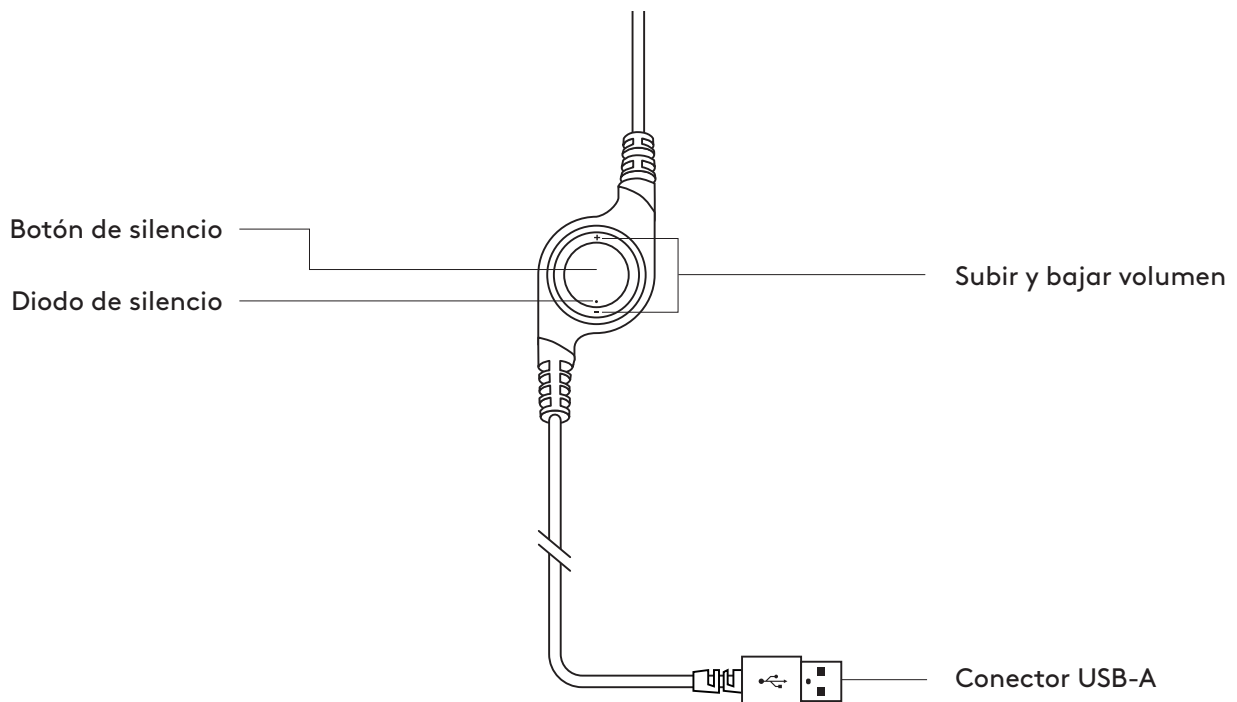

## CONEXIÓN DE LOS AURICULARES

Conecta el conector USB-A al puerto USB del ordenador.

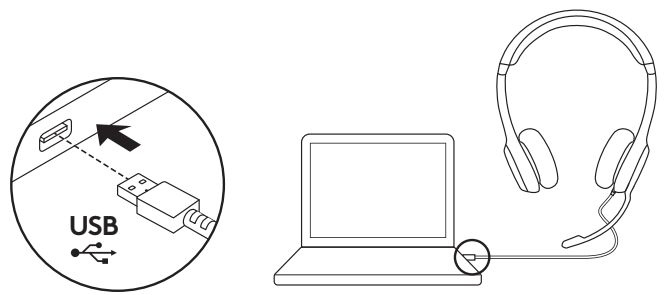

## AJUSTE DE LOS AURICULARES

1. Para ajustar el tamaño de los auriculares, sube y baja la diadema hasta que te resulten cómodos.
2. Mueve la varilla del micrófono hacia arriba o hacia abajo hasta que esté al nivel de la boca para una mejor captura de voz.
3. La varilla se puede guardar, para que no estorbe cuando no se use.

1

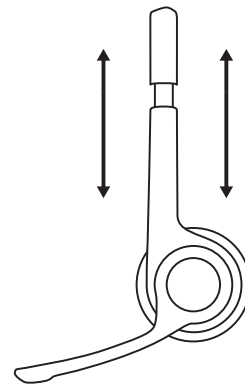

2

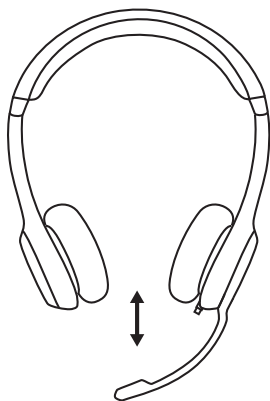

3

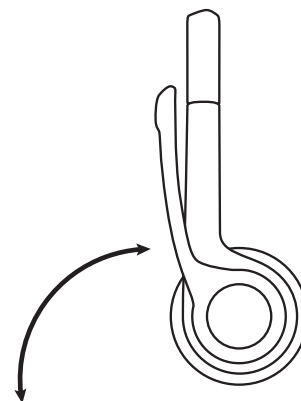

## CONTROLES

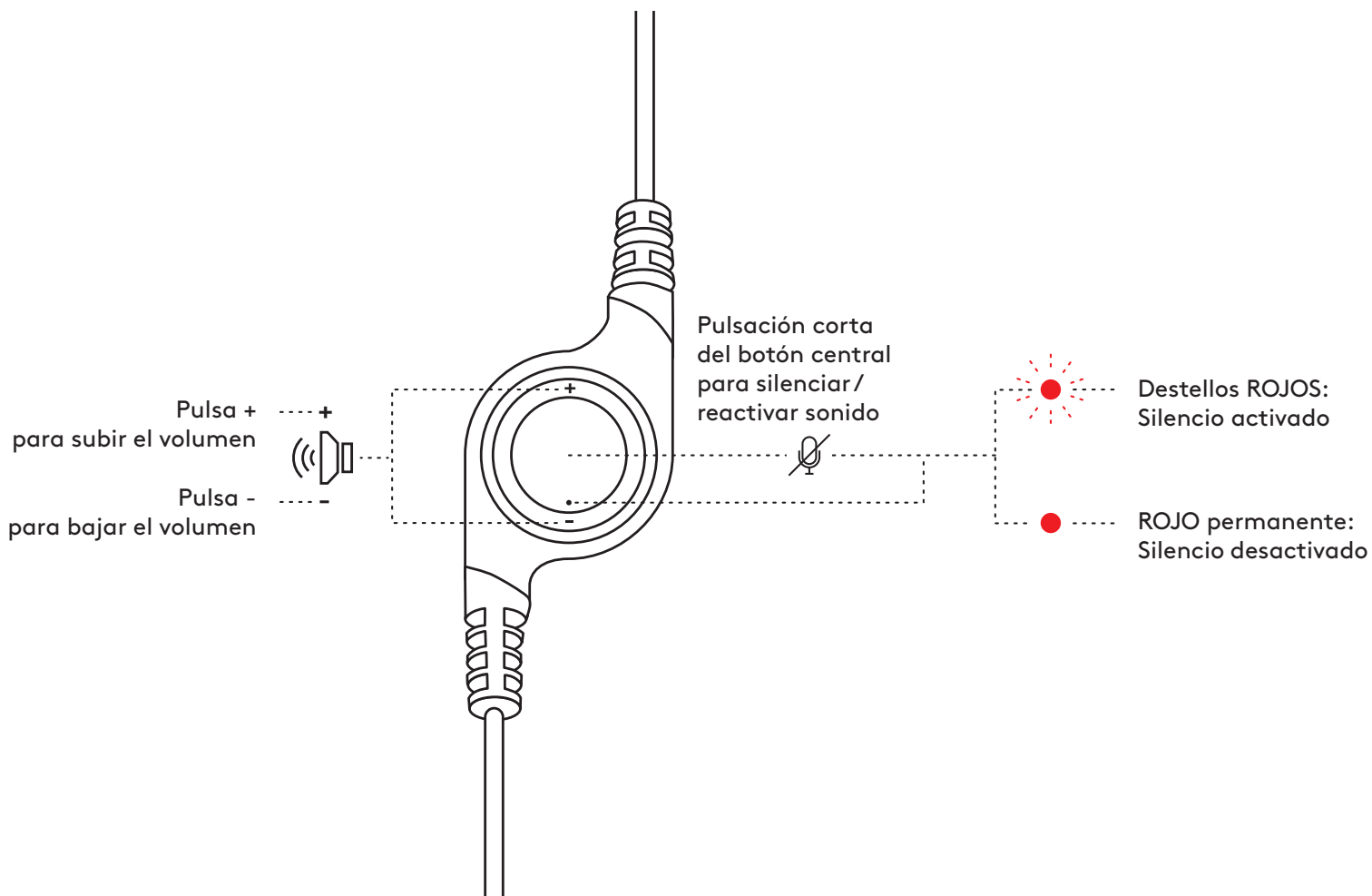

[www.logitech.com/support/H390](http://www.logitech.com/support/H390)

## CONHEÇA O SEU PRODUTO

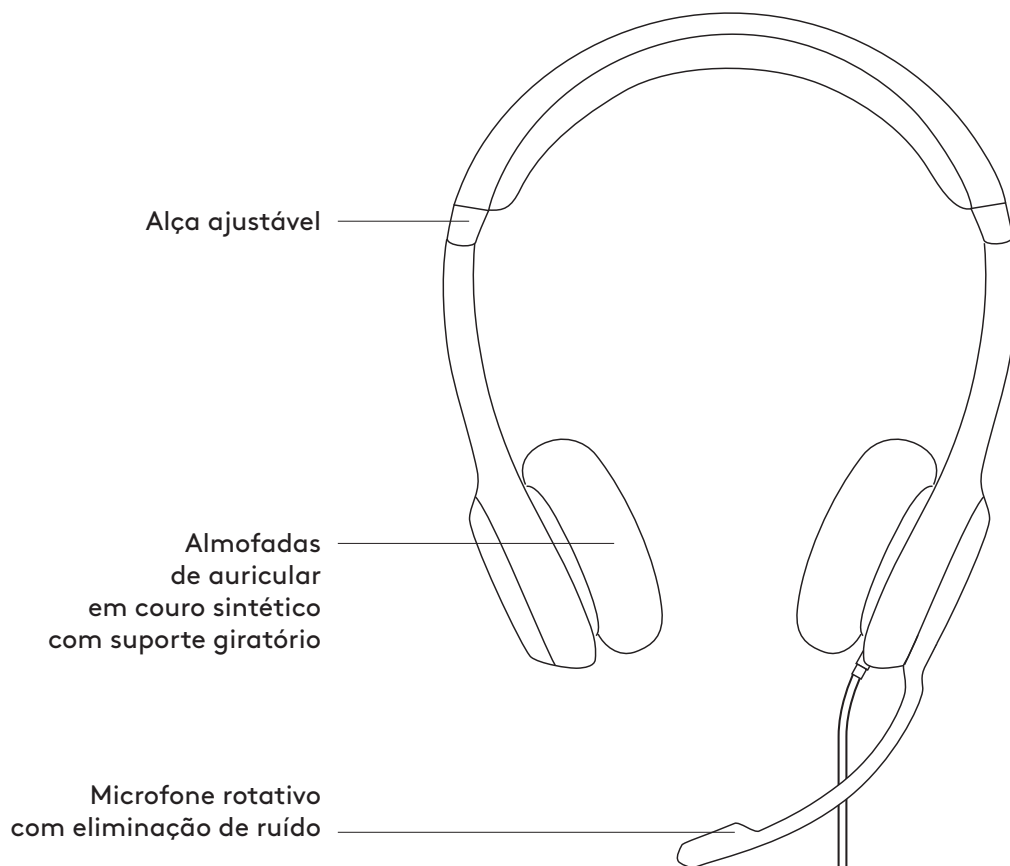

## CONTROLADOR INTEGRADO

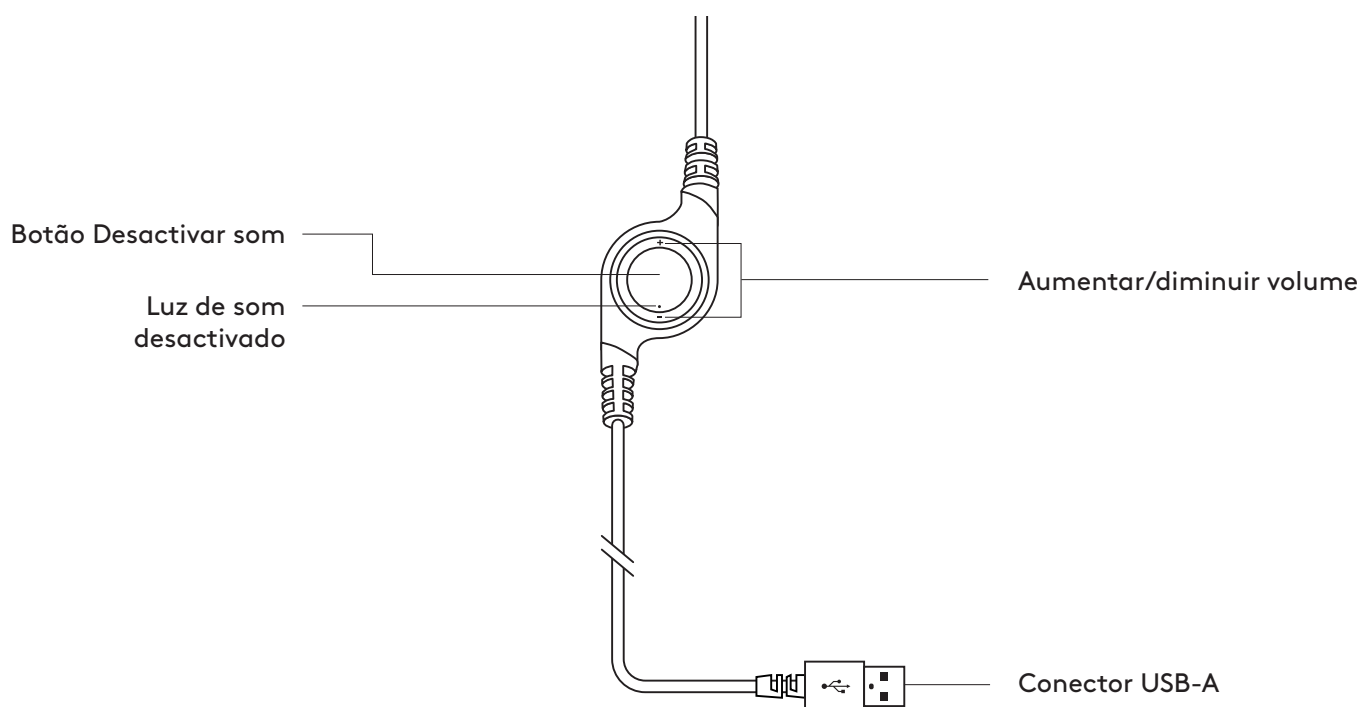

## LIGAR OS AUSCULTADORES

Ligue o conector USB-A à porta USB do seu computador.

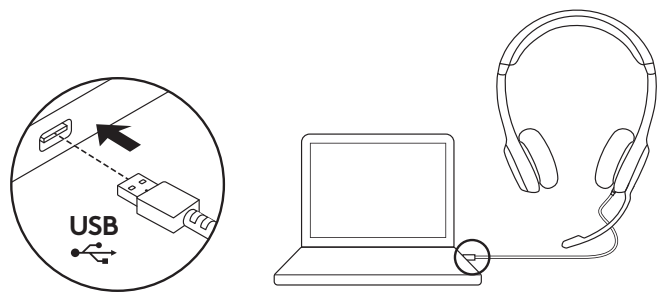

## AJUSTE DOS AUSCULTADORES

1. Para ajustar o tamanho dos auscultadores, mova a alça para cima e para baixo até que esteja confortável.
2. Mova a haste do microfone para cima ou para baixo até que esteja nivelado com a sua boca para melhor captação da sua voz.
3. Pode afastar a haste quando não utilizar o microfone.

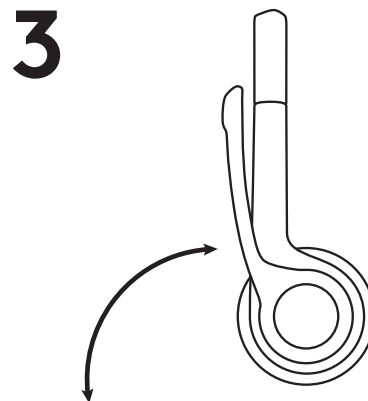
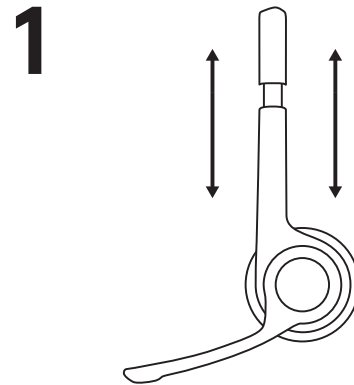

## CONTROLOS

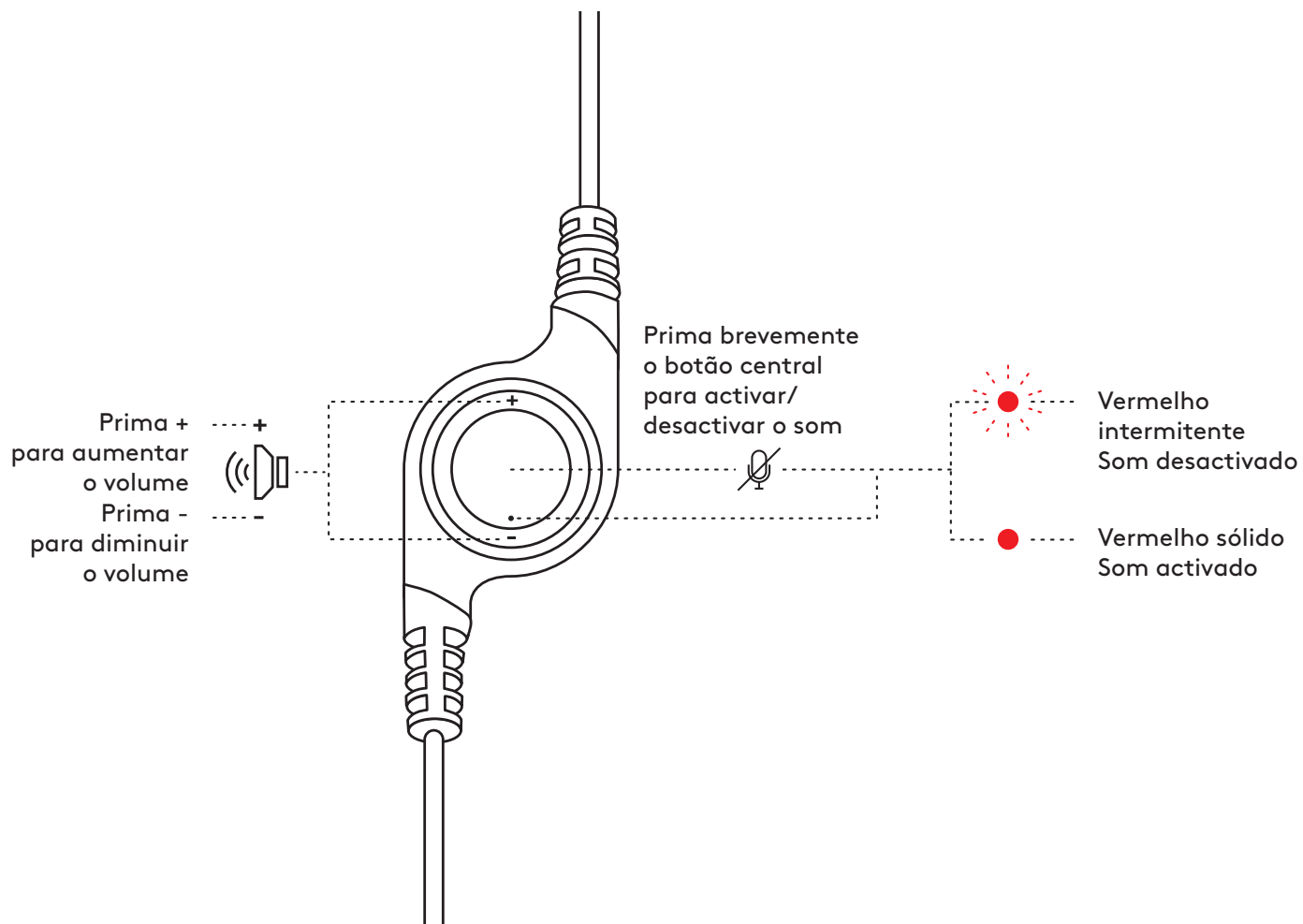

[www.logitech.com/support/H390](http://www.logitech.com/support/H390)



## KEN JE PRODUCT

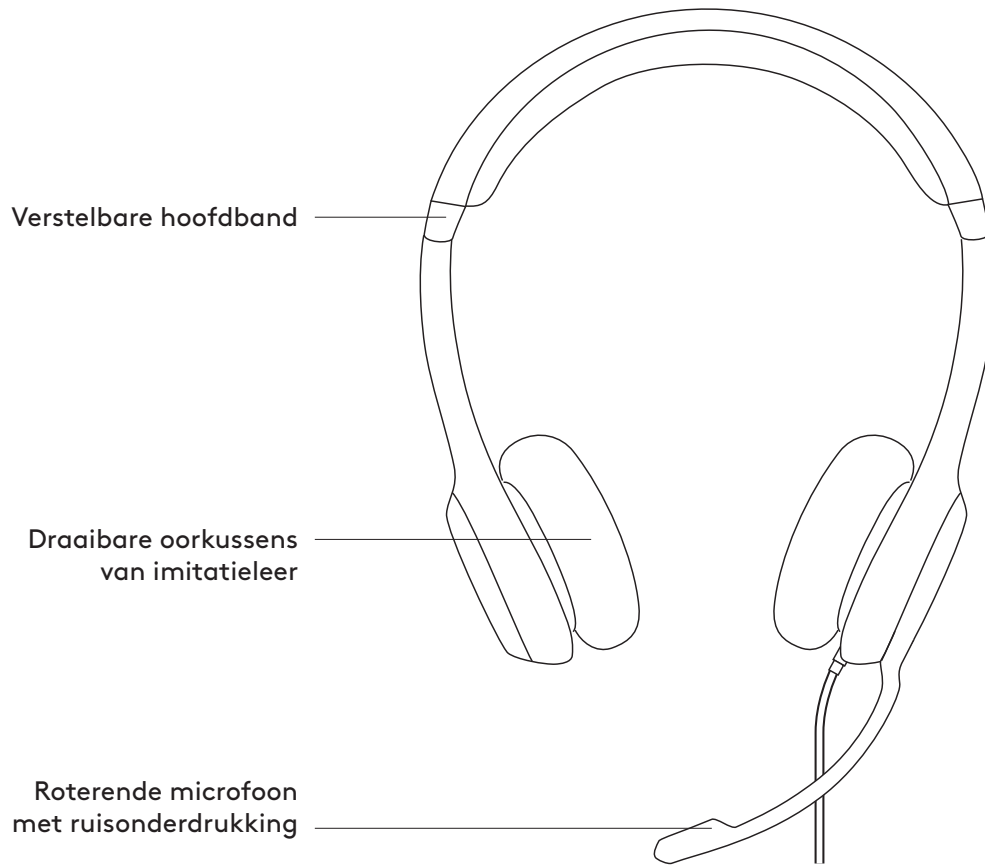

## BEDIENING OP DE DRAAD

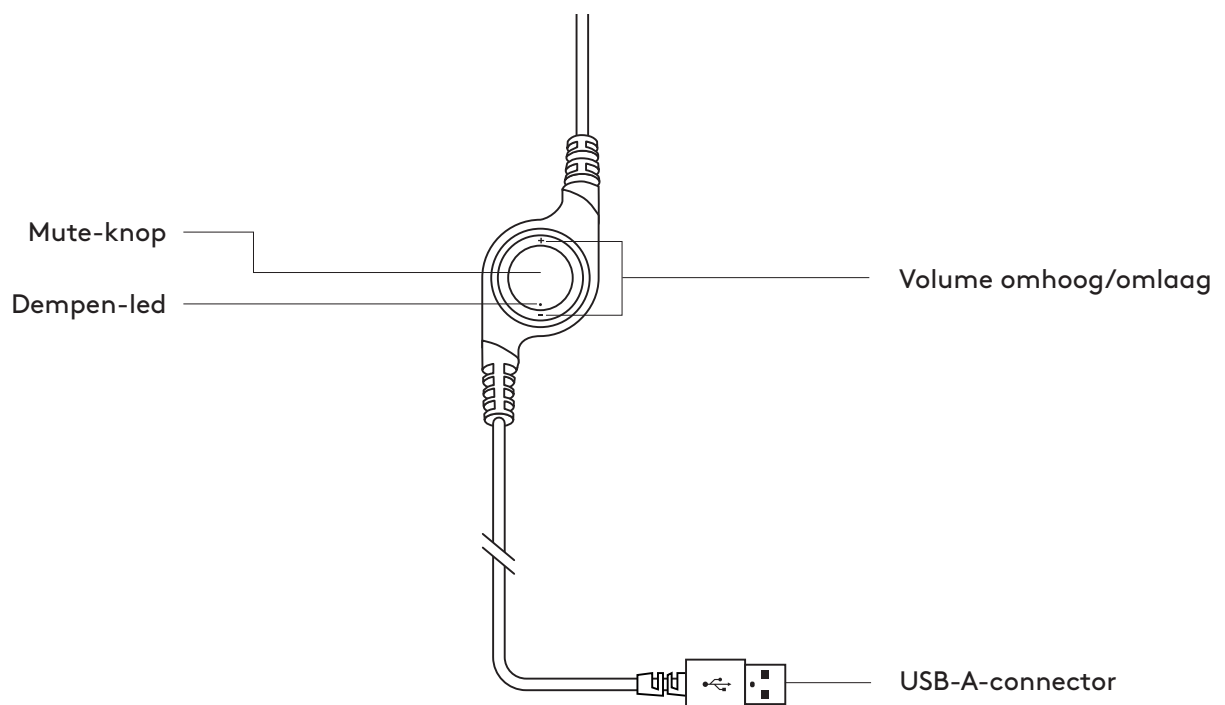

## DE HEADSET AANSLUITEN

Sluit de USB-A-connector aan op de USB-poort van de computer.

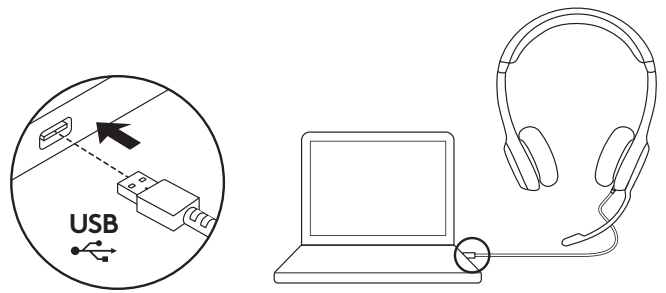

## PASVORM VAN DE HEADSET

1. Pas de headset aan door de hoofdband omhoog en omlaag te bewegen tot deze comfortabel zit.
2. Beweeg de microfoonarm omhoog of omlaag tot deze voor je mond is voor betere stemopname.
3. De microfoon kan worden weggestopt wanneer je deze niet nodig hebt.

1

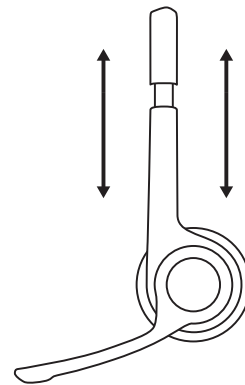

22

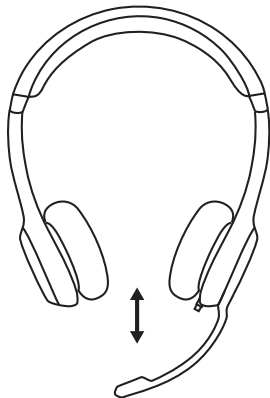

3

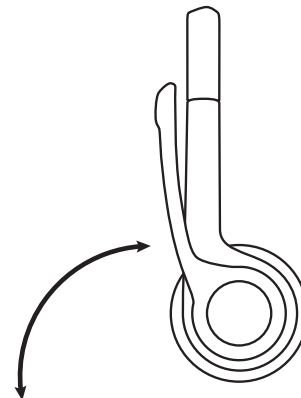

## KNOPPEN

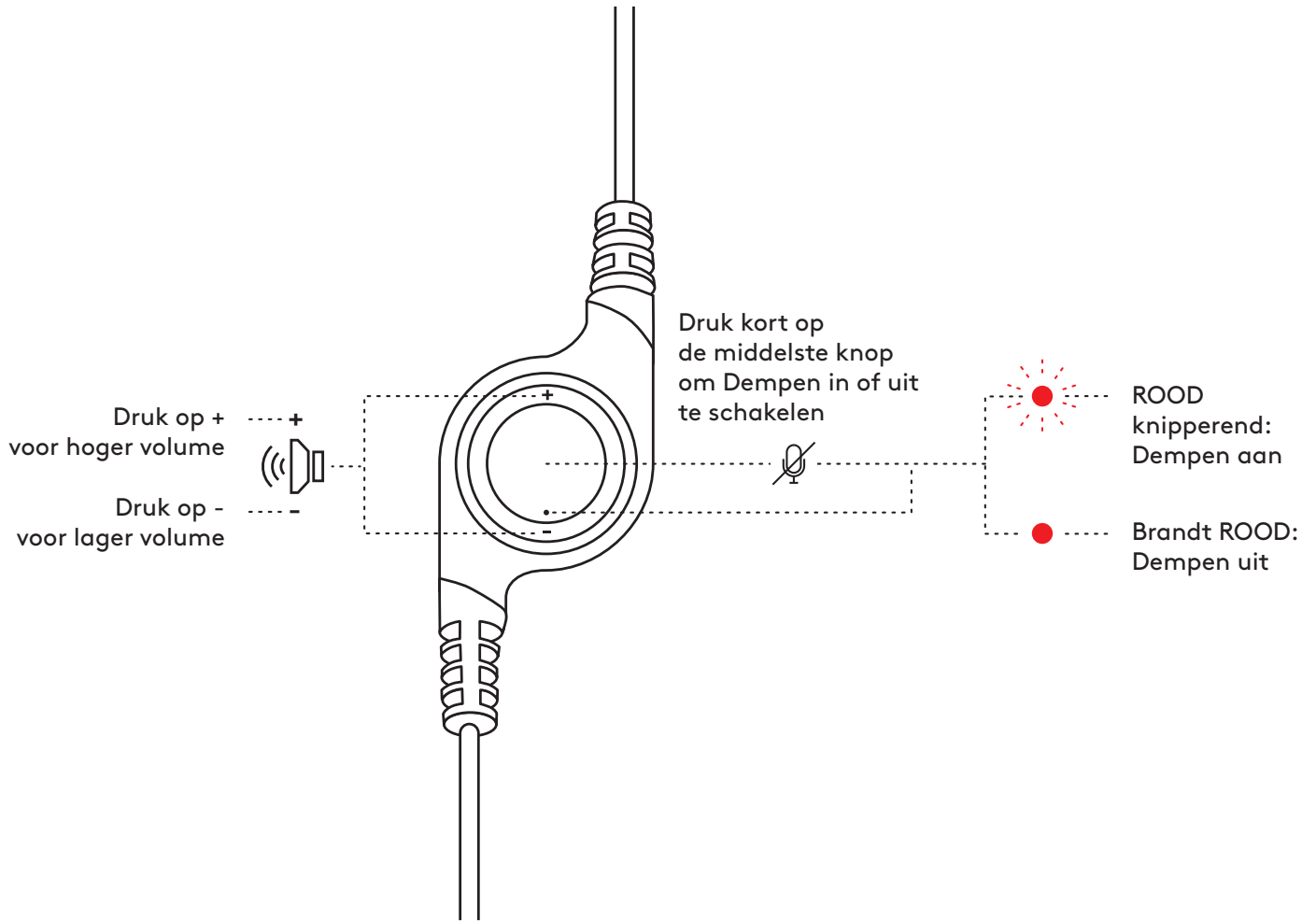

[www.logitech.com/support/H390](http://www.logitech.com/support/H390)

## PRODUKTÖVERSIKT

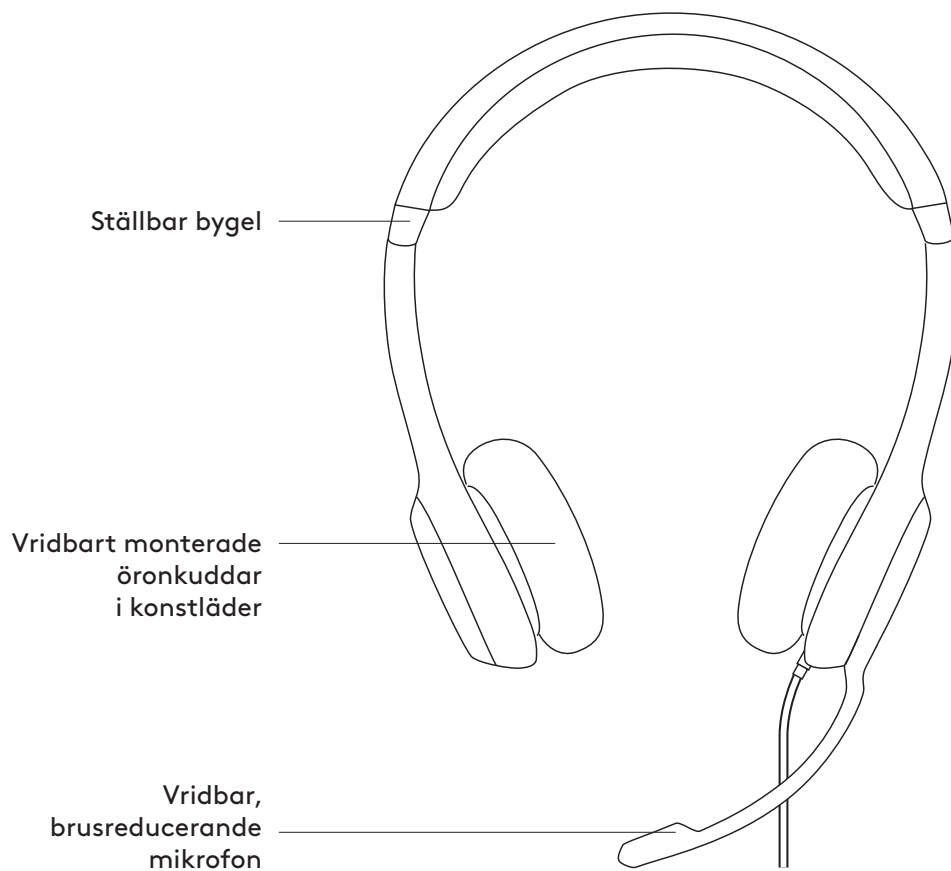

## SLADDMONTERADE REGLAGE

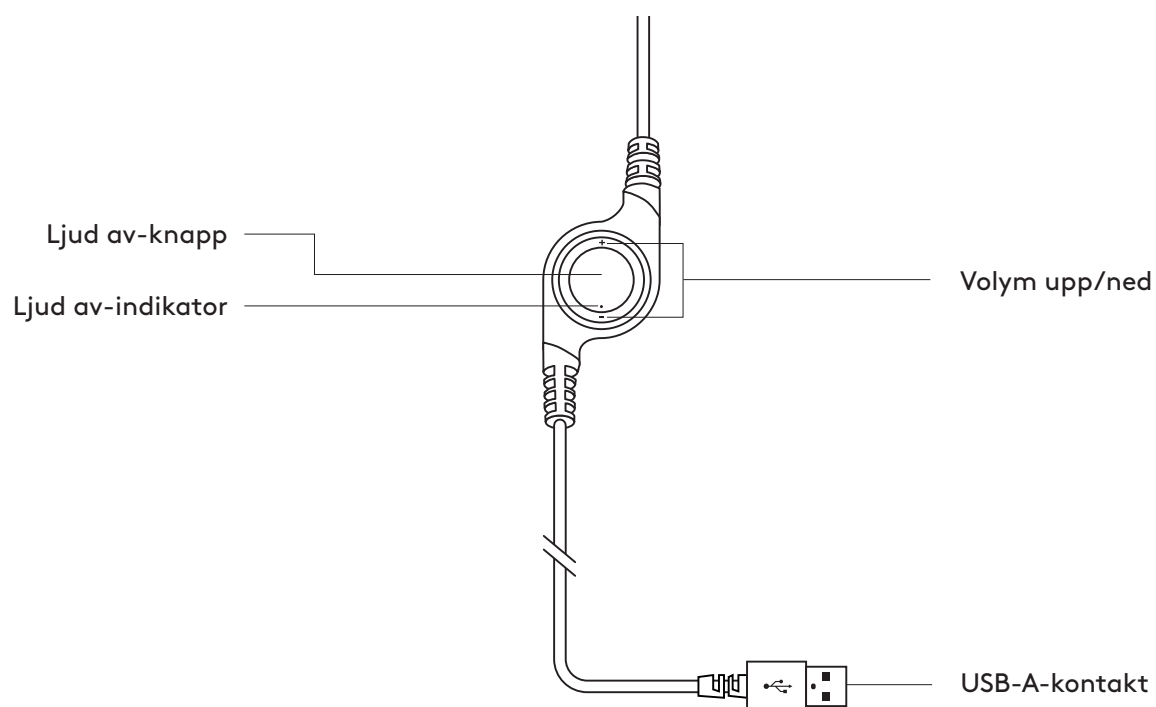

## ANSLUTA HEADSETET

Anslut USB-A-kontakten till en USB-port på datorn.

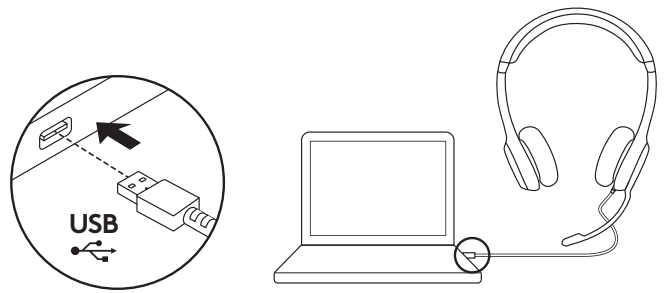

## STÄLLA IN HEADSETET

1. Justera headsetets storlek genom att flytta bygeln upp och ner tills headsetet sitter bekvämt.
2. Flytta mikrofonen upp eller ner tills den är i höjd med munnen för bättre röstupptagning.
3. Mikrofonbommen kan flyttas ur vägen när den inte används.

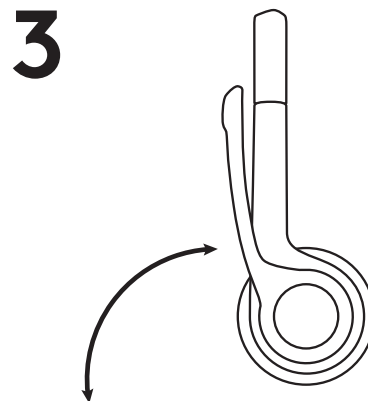
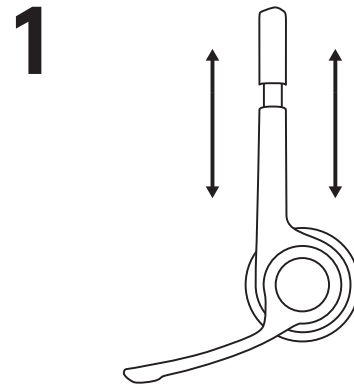

## REGLAGE

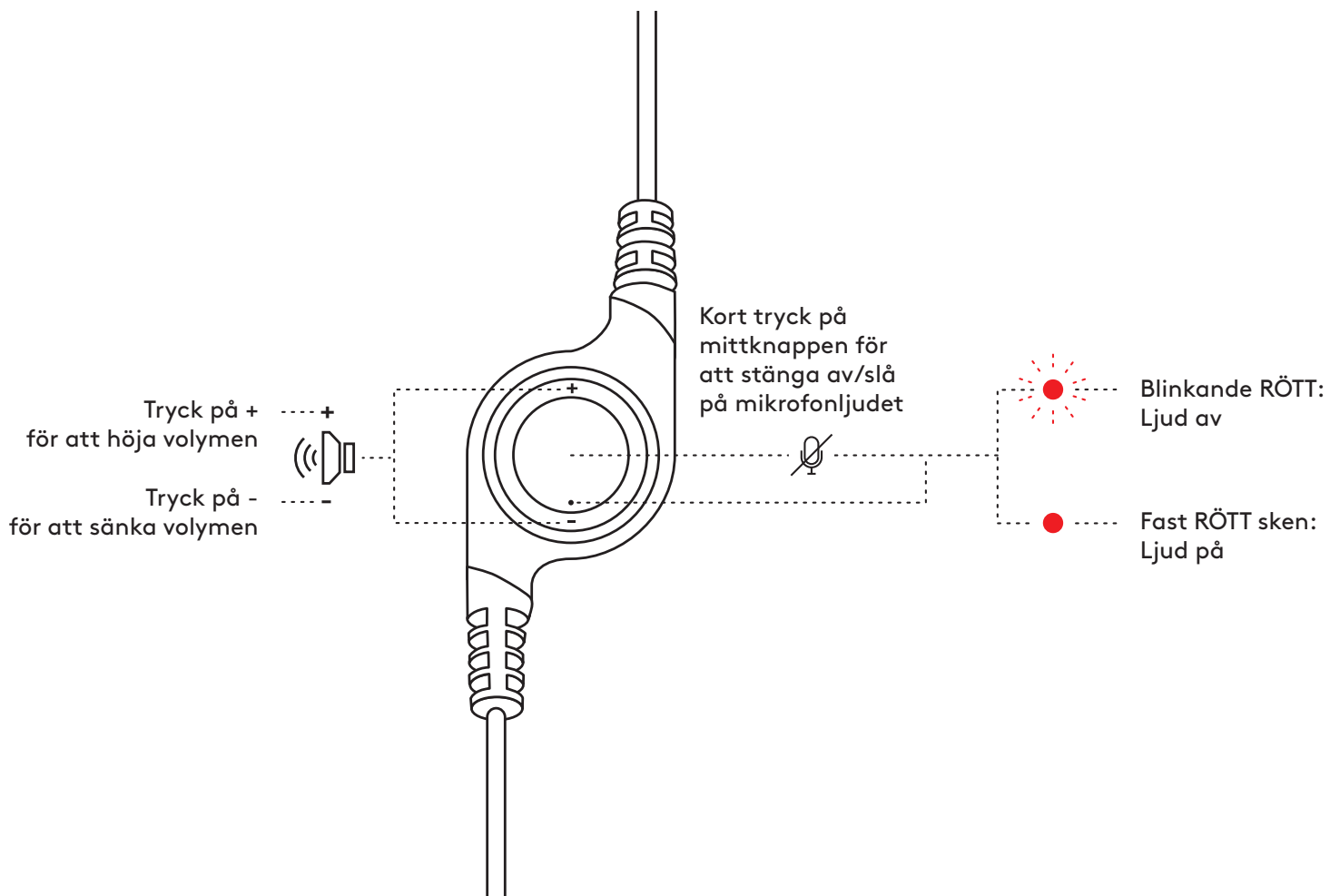

[www.logitech.com/support/H390](http://www.logitech.com/support/H390)

## OVERSIGT OVER PRODUKTET

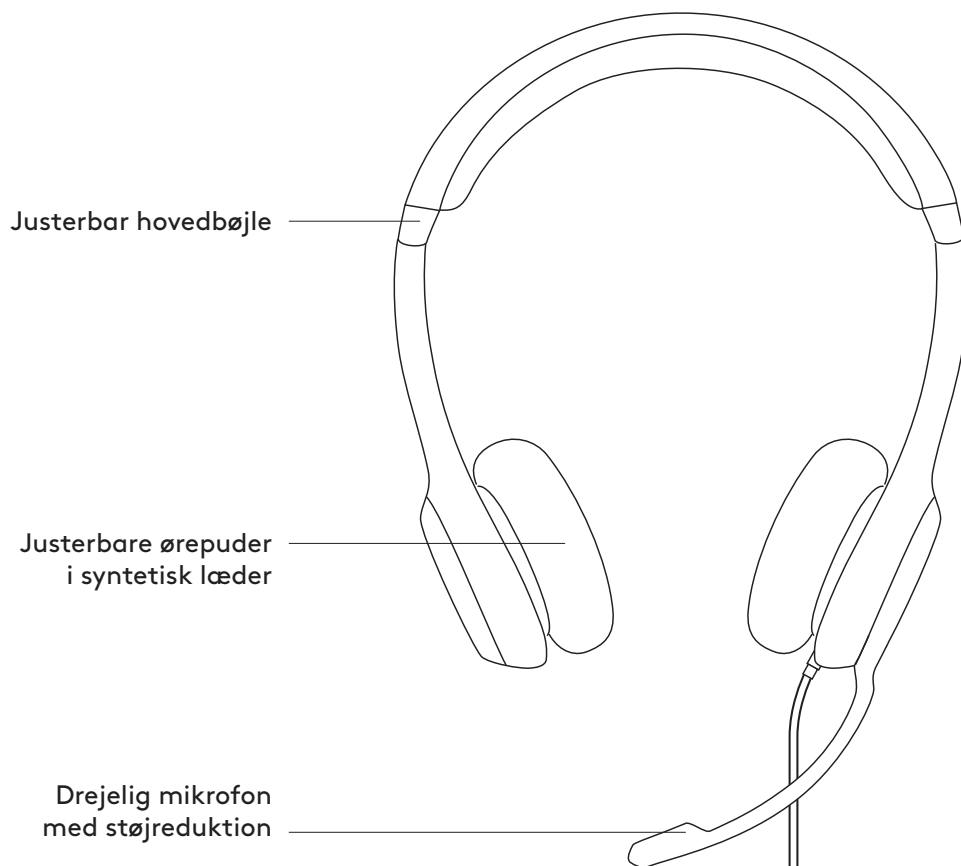

## KONTROLKNAPPER PÅ LEDNINGEN

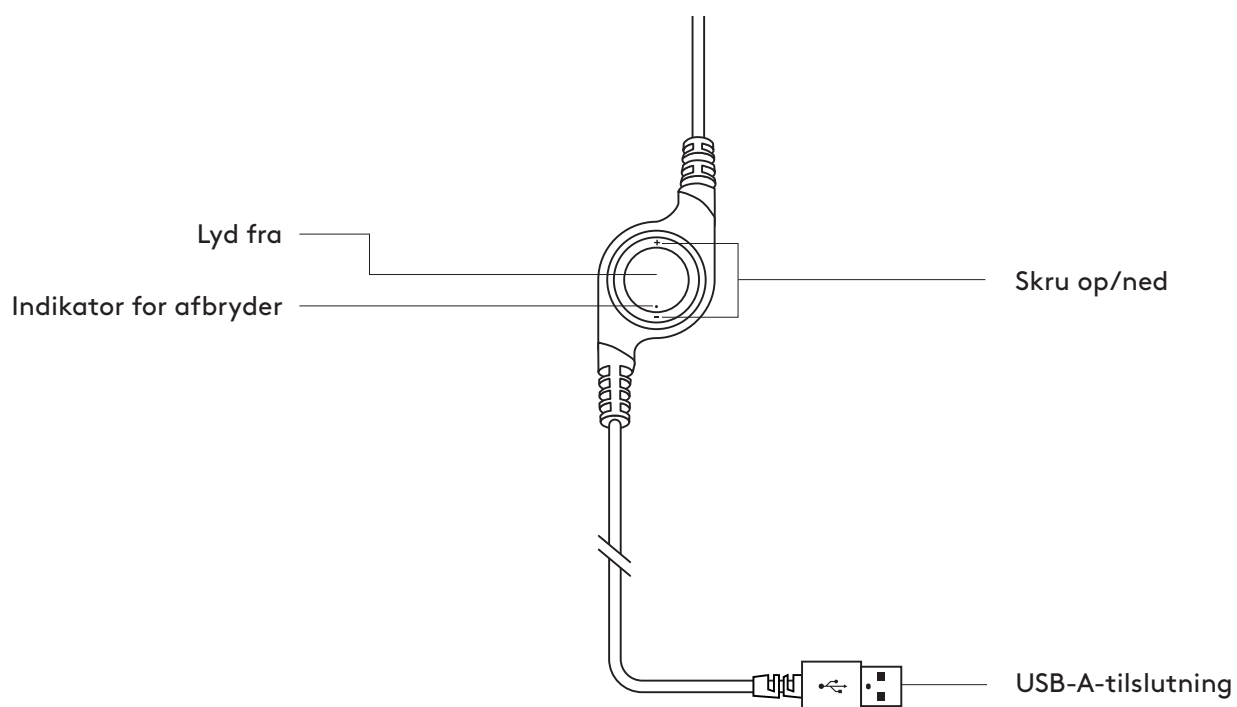

## TILSLUTNING AF HEADSETTET

Slut USB-A-stikket til en USB-port på computeren.

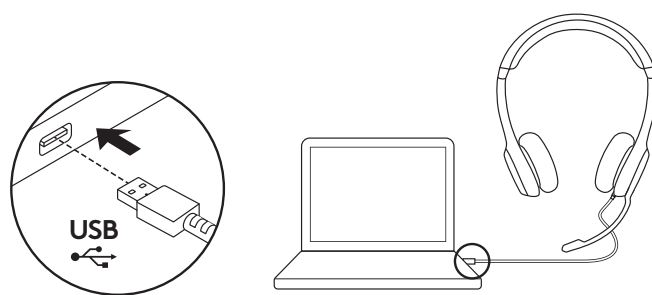

## TILPASNING AF HEADSETTET

1. Headsettet justeres i størrelsen ved at flytte hovedbøjlen op og ned, til det føles behageligt.
2. Flyt mikrofonarmen op eller ned, indtil den er ud for munden, så du får den bedste lyd.
3. Mikrofonarmen kan gemmes af vejen når du ikke bruger mikrofonen.

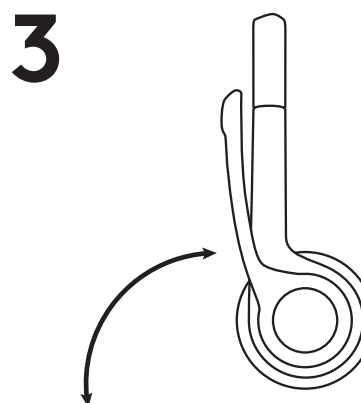
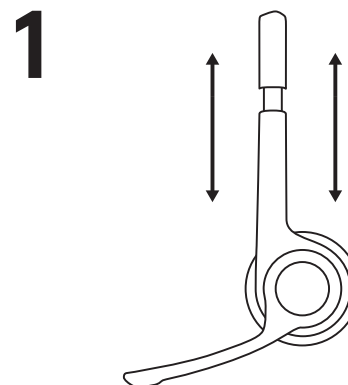



## KONTROLKNAPPER

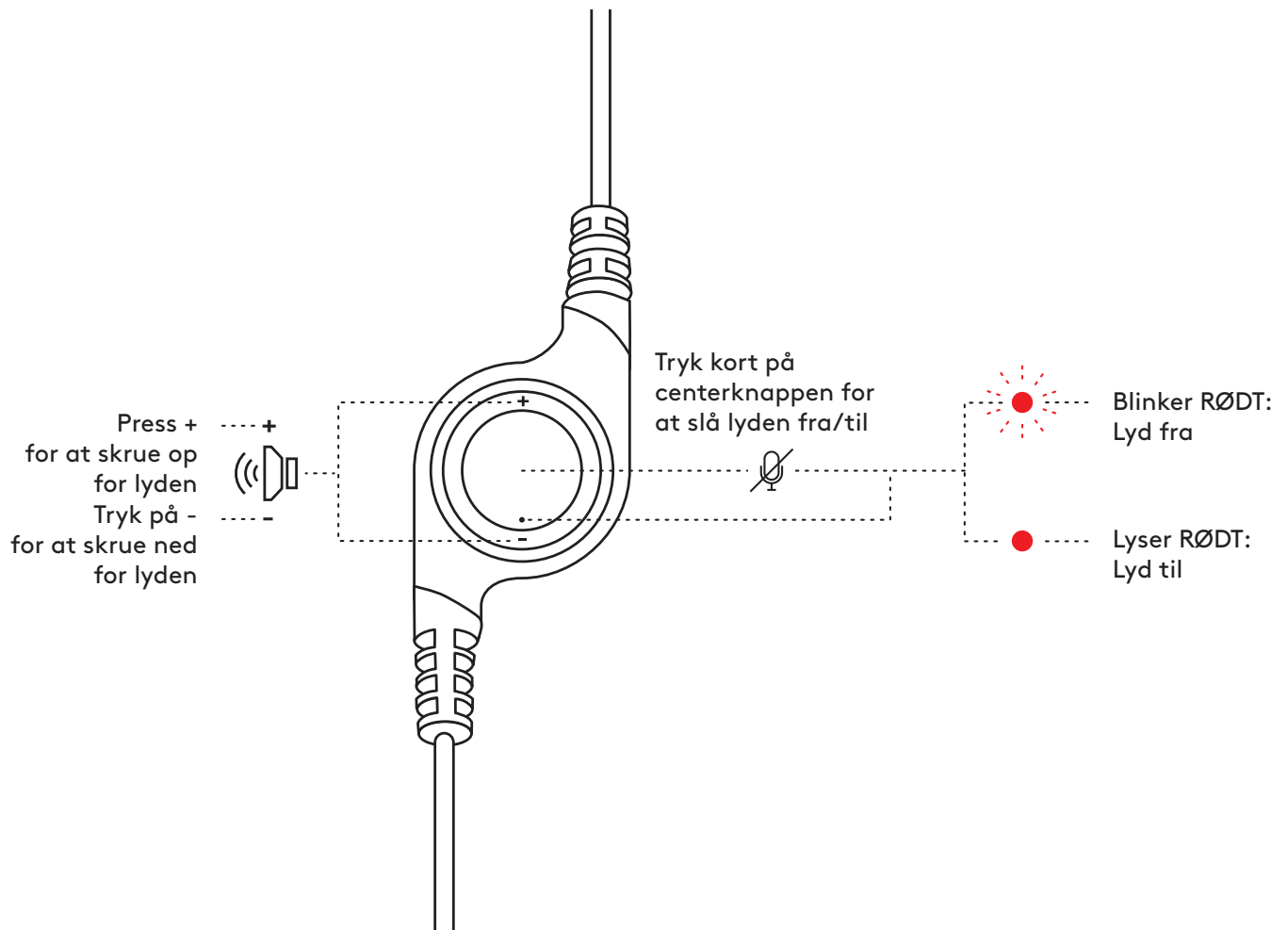

[www.logitech.com/support/H390](http://www.logitech.com/support/H390)

## BLI KJENT MED PRODUKTET

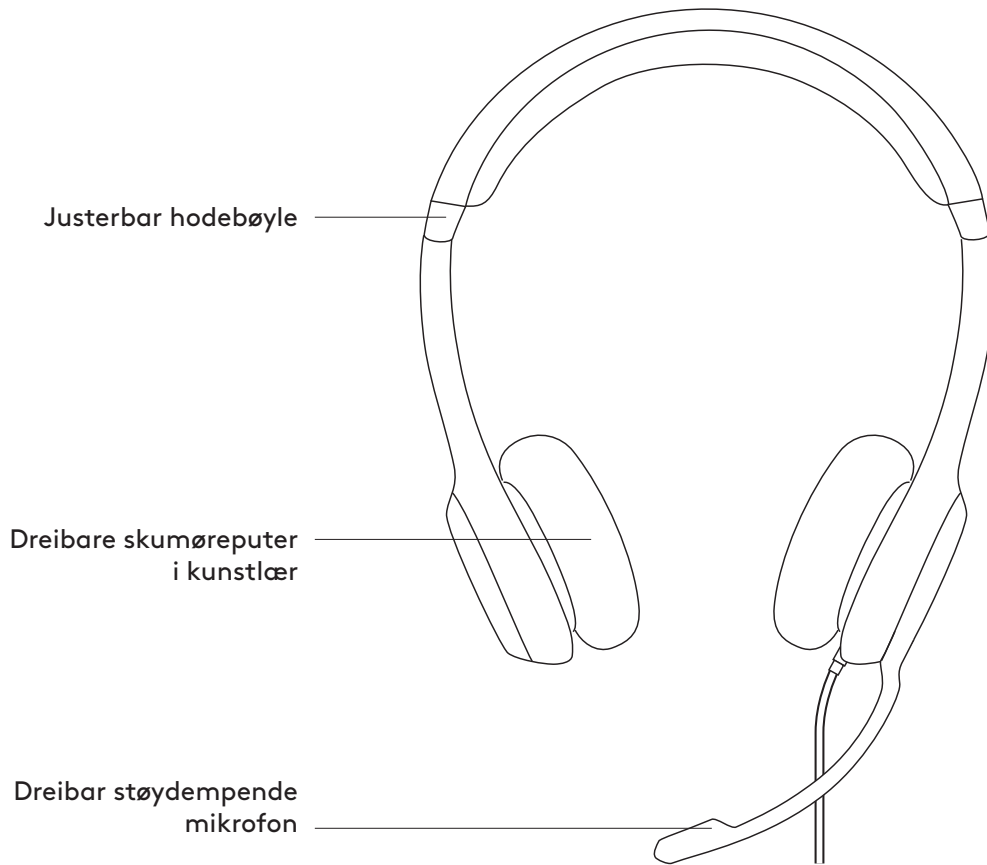

## INTEGRERTE KONTROLLER PÅ LEDNINGEN

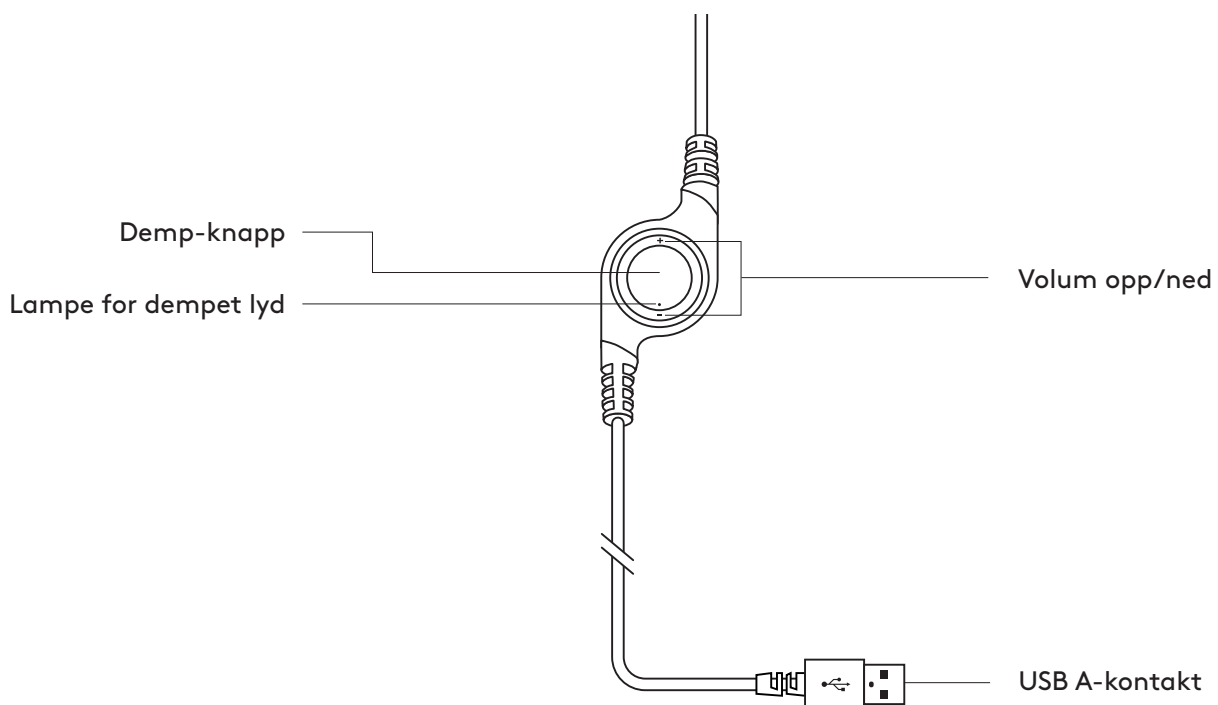

## KOBLE TIL HEADSETTET

Koble Unifying-mottakeren til en USB-port på datamaskinen.

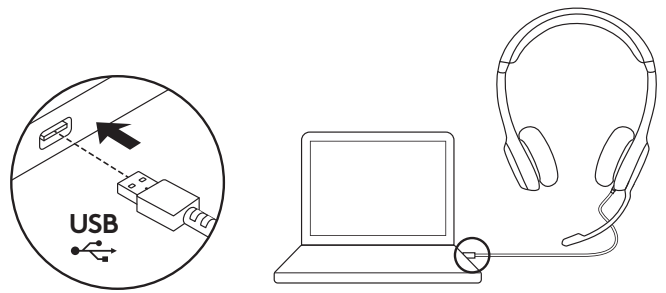

## JUSTERE HEADSETTET

1. Juster headset-størrelsen ved å flytte hodebøylen opp og ned til den sitter behagelig.
2. Flytt mikrofonarmen opp eller ned og inn eller ut til den er på samme nivå som munnen for å gjøre det enklere å fange opp stemmen din.
3. Telefonarmen kan skyves unna når du ikke bruker den.

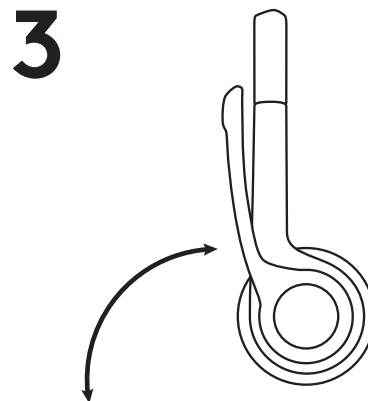
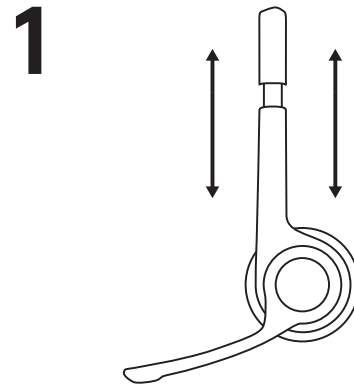

## KONTROLLERE

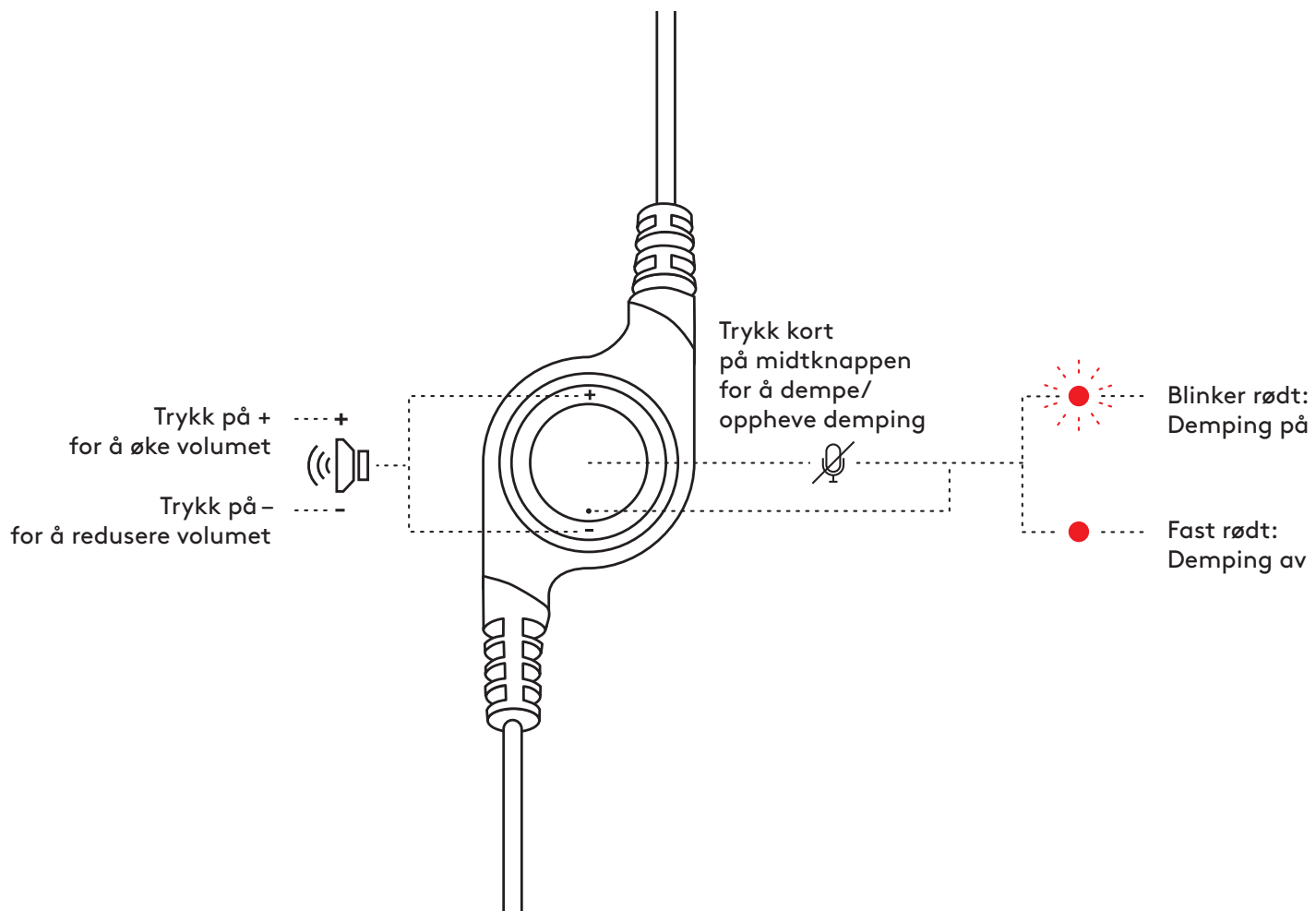

[www.logitech.com/support/H390](http://www.logitech.com/support/H390)

## TUNNE TUOTTEESI

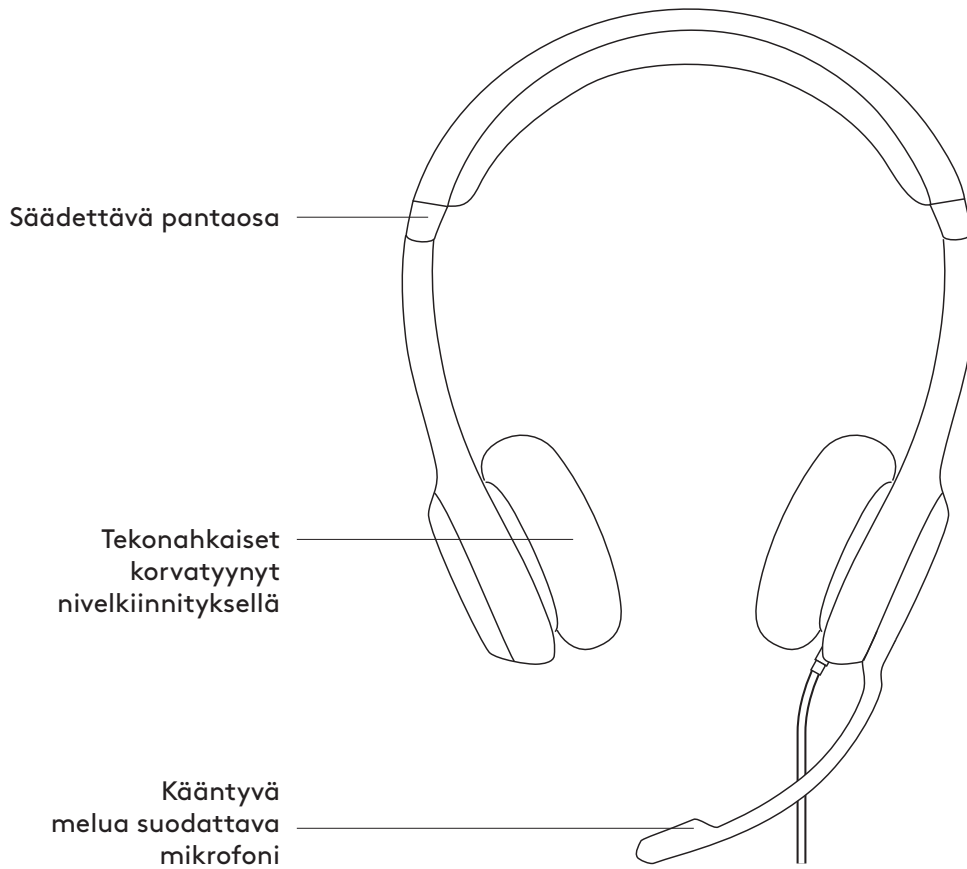

## JOHDOSSA OLEVAT OHJAUSPAINIKKEET

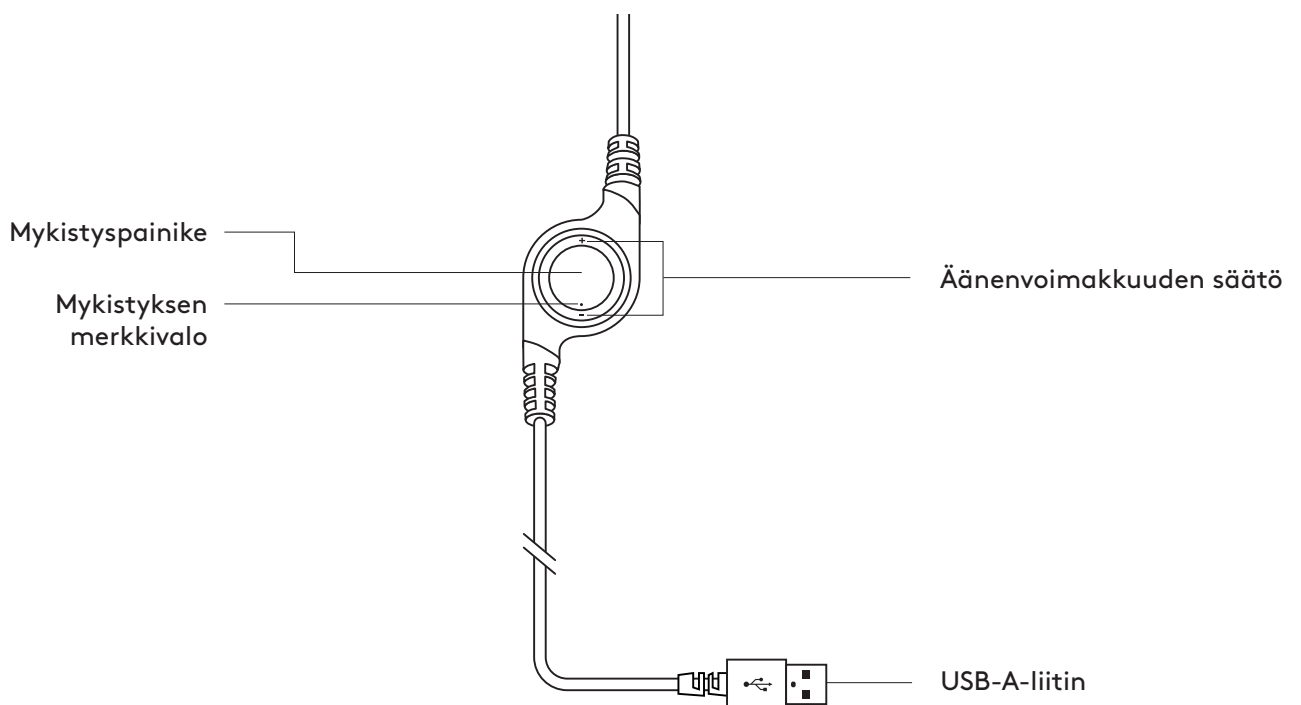

## KUULOKEMIKROFONIN LIITTÄMINEN

Kytke USB-A-liitin tietokoneen USB-porttiin.

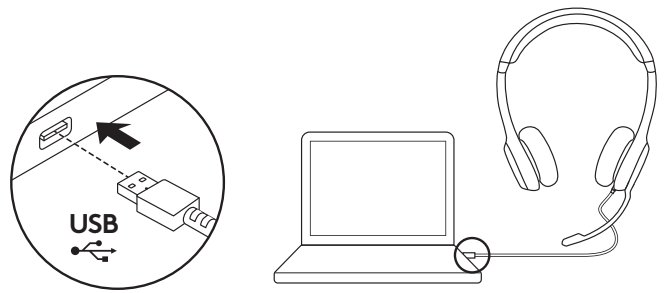

## KUULOKEMIKROFONIN ISTUVUUS

1. Säädä kuulokkeen kokoa siirtämällä pantaosaa ylös ja alas, kunnes se istuu mukavasti.
2. Liikuta mikrofonin vartta äänenlaadun parantamiseksi ylös- tai alaspäin, kunnes mikrofoni on suusi tasolla.
3. Mikrofonivarsi voidaan painaa pois tieltä, kun sitä ei tarvita.

1

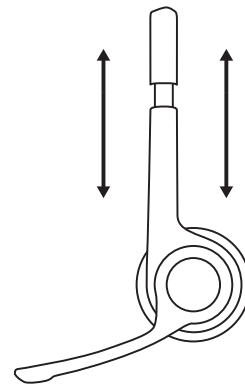

2

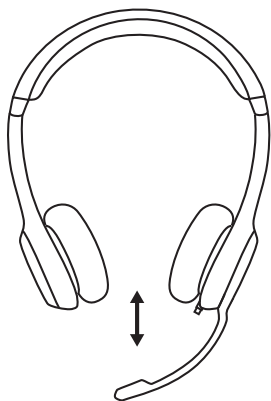

3

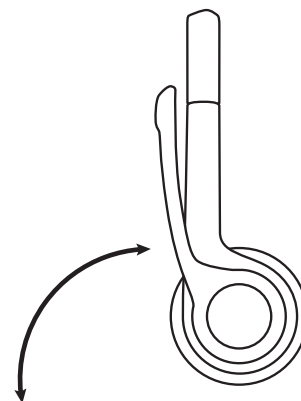

## SÄÄTIMET

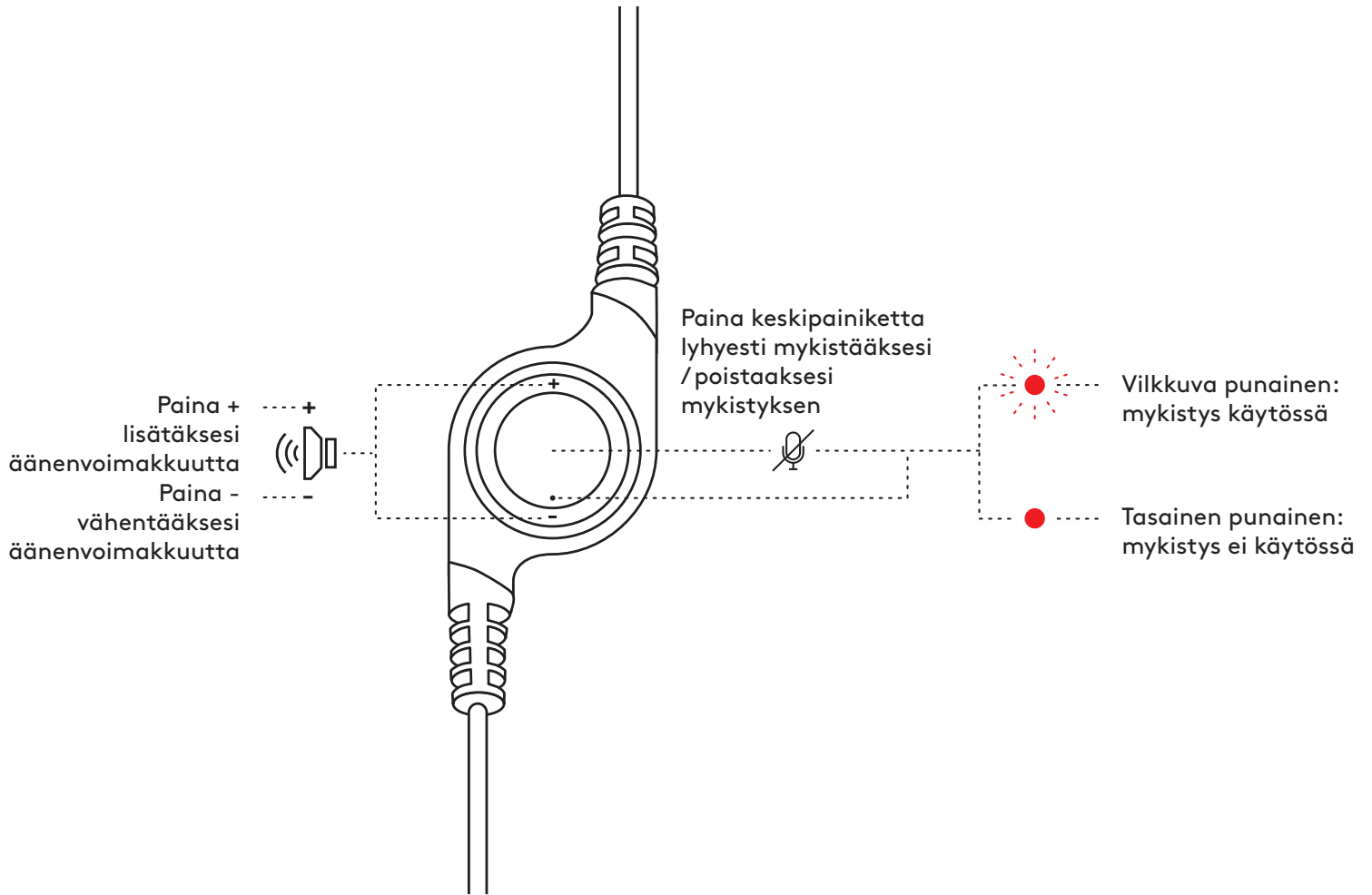

[www.logitech.com/support/H390](http://www.logitech.com/support/H390)

## ΓΝΩΡΙΣΤΕ ΤΟ ΠΡΟΪΟΝ

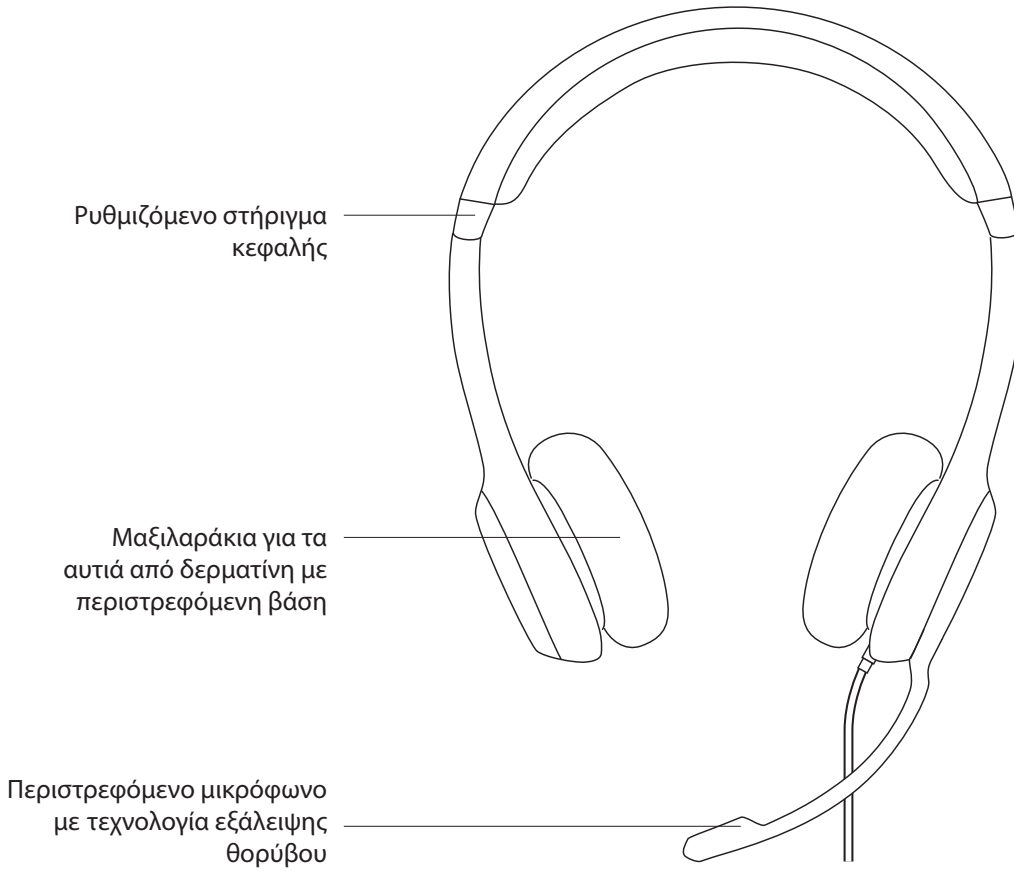

## ΧΕΙΡΙΣΤΗΡΙΟ ΣΤΟ ΚΑΛΩΔΙΟ

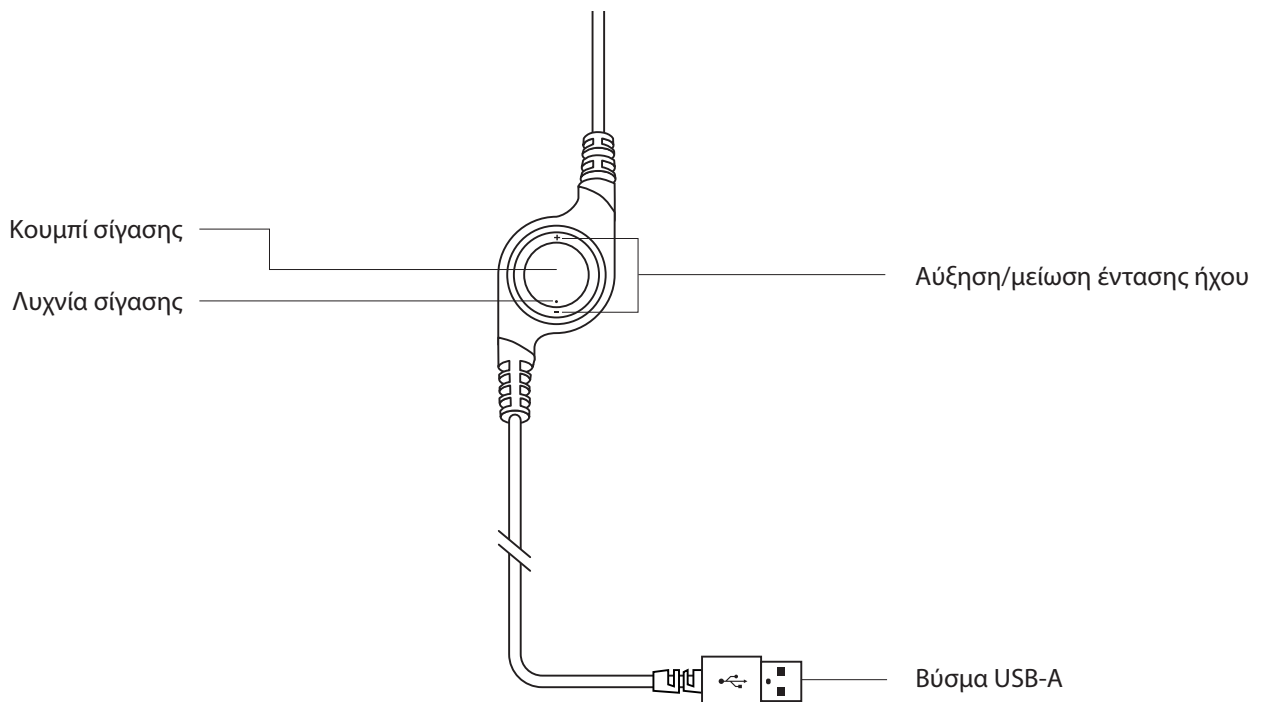



## ΣΥΝΔΕΣΗ ΤΟΥ ΣΕΤ ΜΙΚΡΟΦΩΝΟΥ-ΑΚΟΥΣΤΙΚΩΝ

Συνδέστε το βύσμα USB-A στην θύρα USB του υπολογιστή.

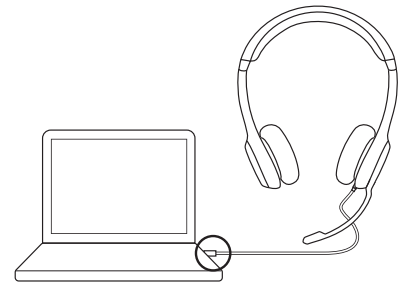
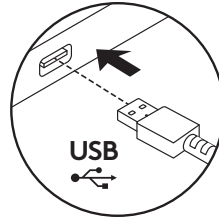

## ΕΦΑΡΜΟΓΗ ΣΕΤ ΜΙΚΡΟΦΩΝΟΥ-ΑΚΟΥΣΤΙΚΩΝ

1. Για να προσαρμόσετε το μέγεθος του σετ μικροφώνου-ακουστικών, μετακινήστε το στήριγμα κεφαλής προς τα επάνω και προς τα κάτω μέχρι να εφαρμόσει άνετα στο κεφάλι σας.
2. Μετακινήστε τον βραχίονα του μικροφώνου προς τα επάνω ή προς τα κάτω μέχρι να το ευθυγραμμίσετε με το στόμα σας για να καταγράψει καλύτερα τη φωνή σας.
3. Το μικρόφωνο μπορεί να μετακινηθεί για να μην ενοχλεί όταν δεν χρησιμοποιείται.

1

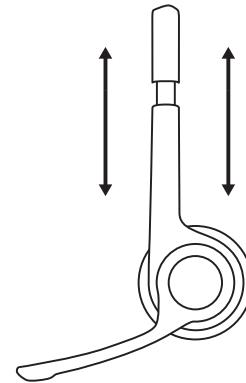

2

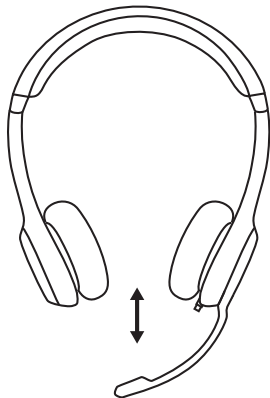

3

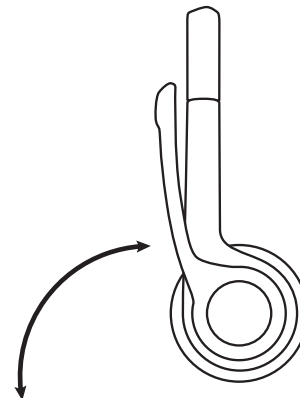

## ΚΟΥΜΠΙΑ ΕΛΕΓΧΟΥ

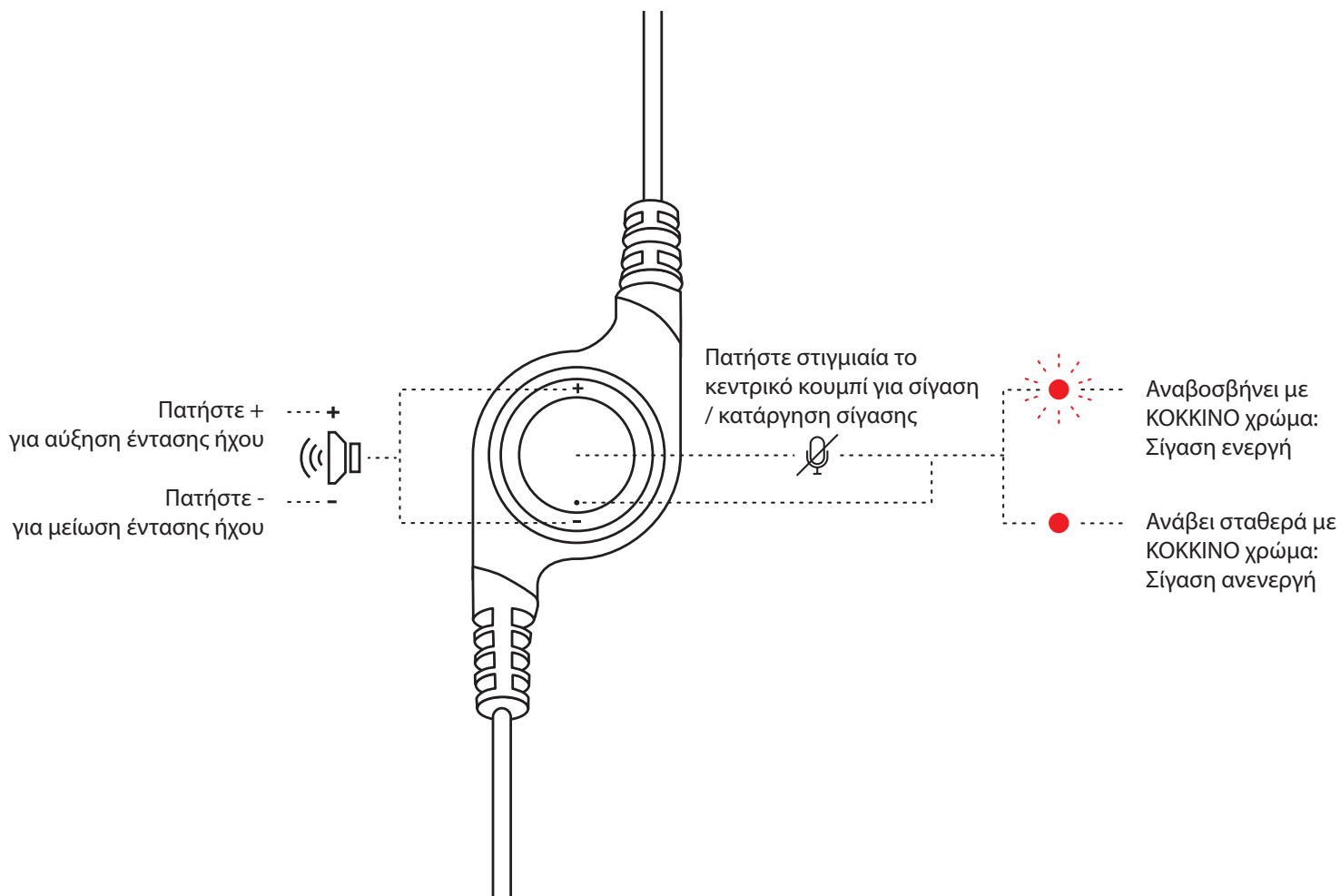

[www.logitech.com/support/H390](http://www.logitech.com/support/H390)

## ЗНАКОМСТВО С ПРОДУКТОМ



## ВСТРОЕННЫЙ КОНТРОЛЛЕР

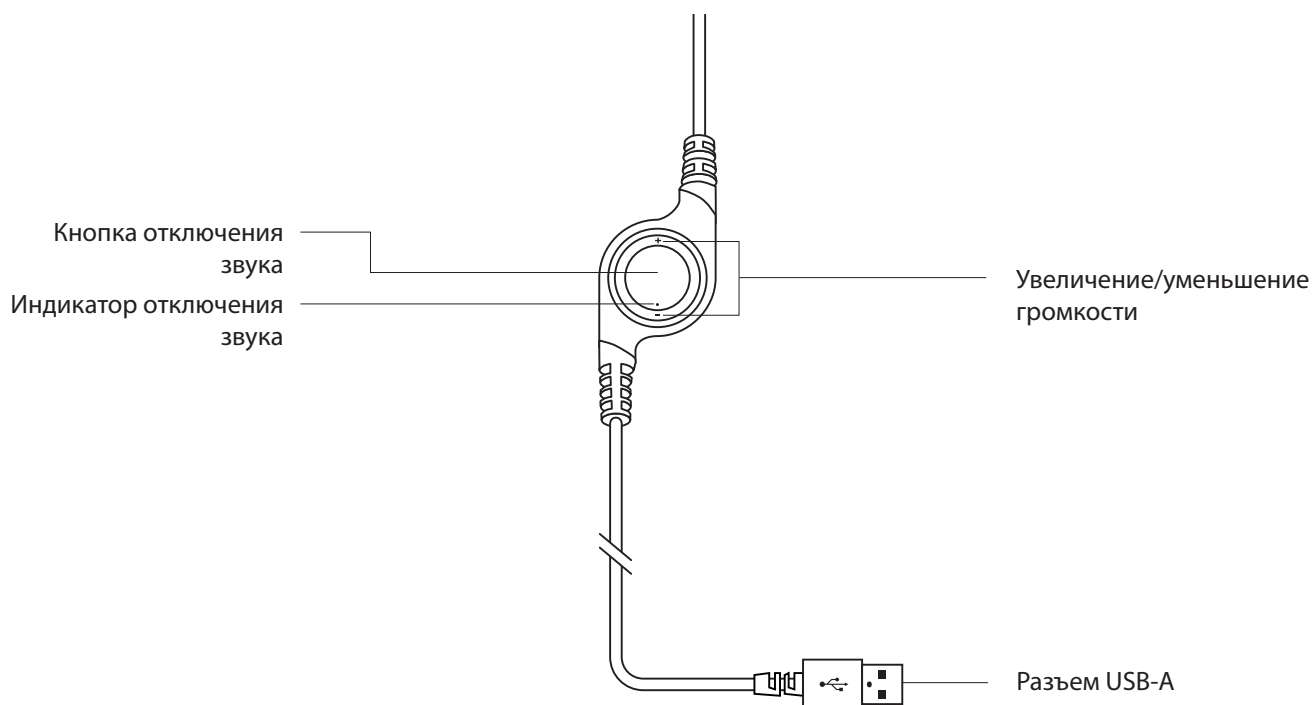

## ПОДКЛЮЧЕНИЕ ГАРНИТУРЫ

Вставьте штекер USB-A в USB-порт компьютера.

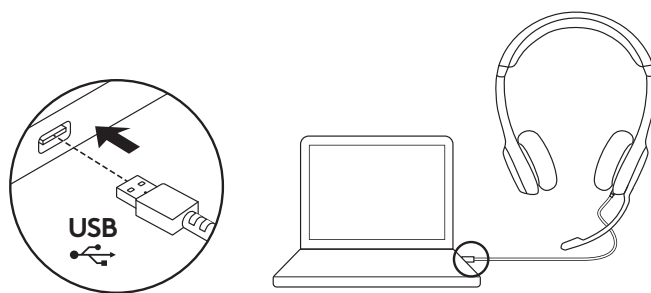

## ПОСАДКА ГАРНИТУРЫ

1. Чтобы подобрать нужную высоту оголовья, двигайте его вверх-вниз, пока гарнитура не сядет как надо.
2. Перемещайте штатив микрофона вверх-вниз, пока он не займет положение, при котором ваш голос передается максимально четко.
3. Когда микрофон не используется, просто отверните держатель в сторону.

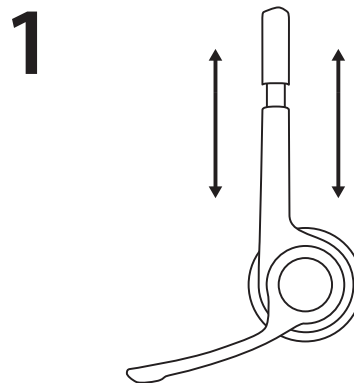

22

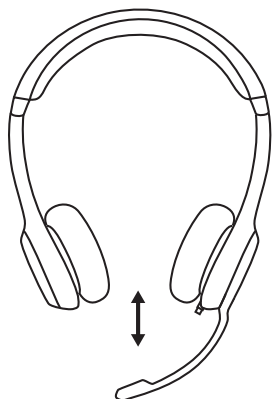

3

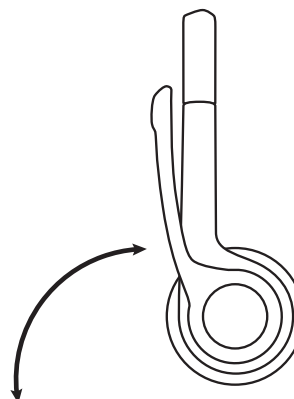

## ЭЛЕМЕНТЫ УПРАВЛЕНИЯ

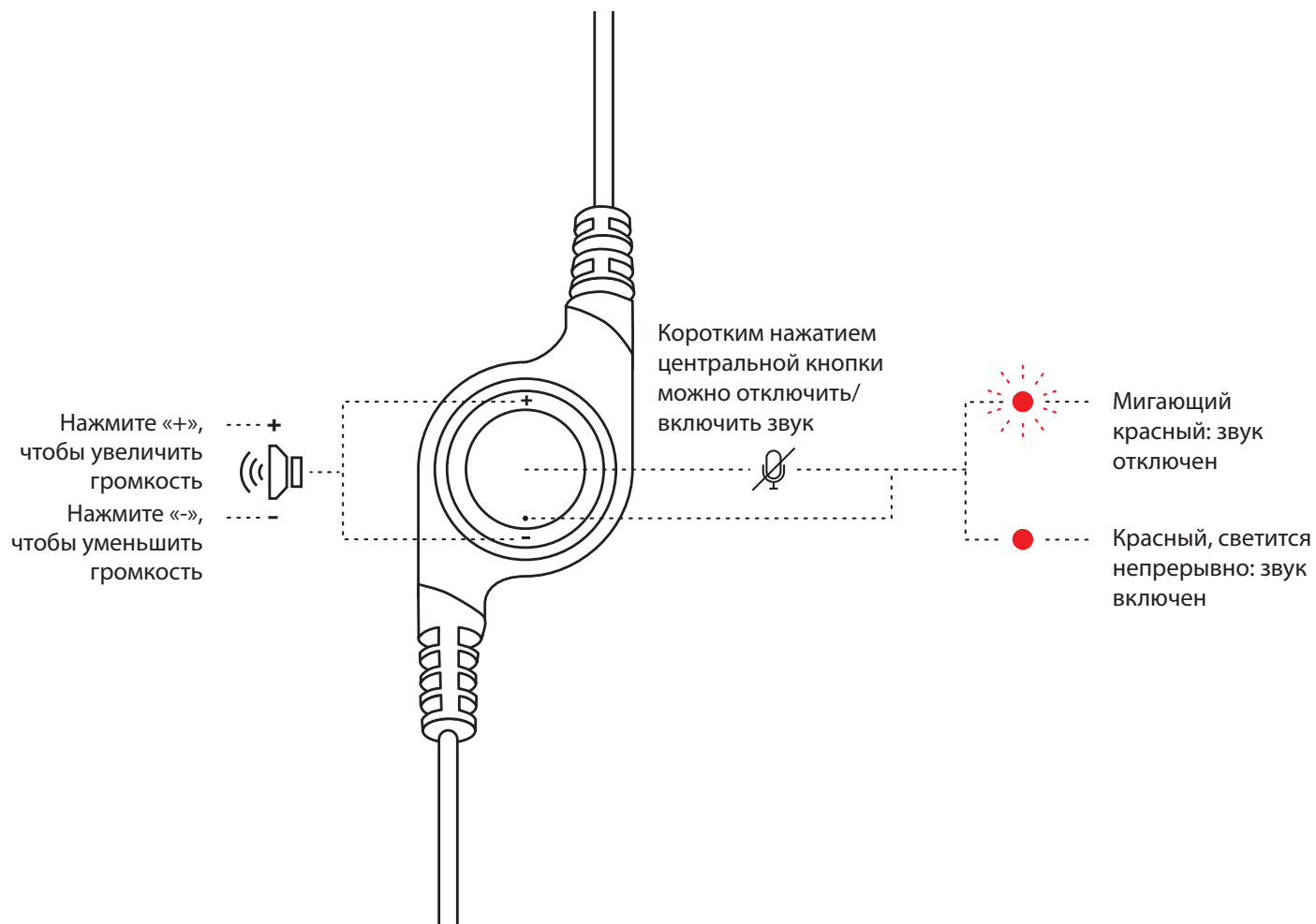

[www.logitech.com/support/H390](http://www.logitech.com/support/H390)

## OPIS URZĄDZENIA

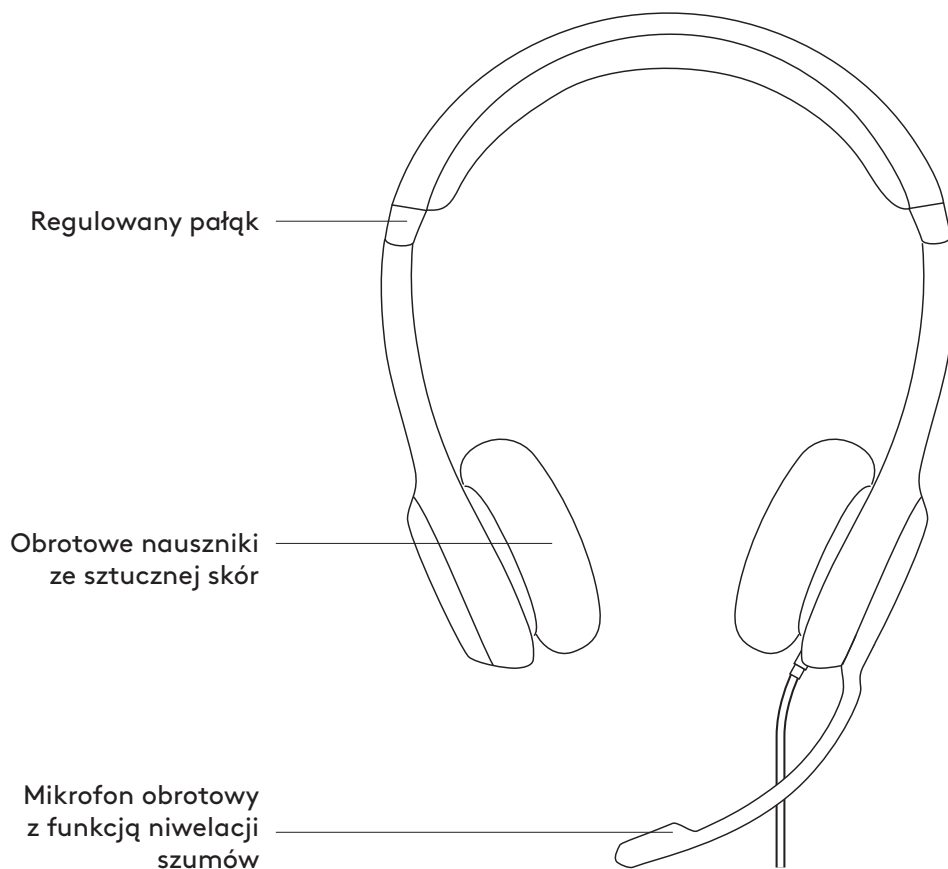

## ELEMENT STERUJĄCY UMIESZCZONY NA KABLU

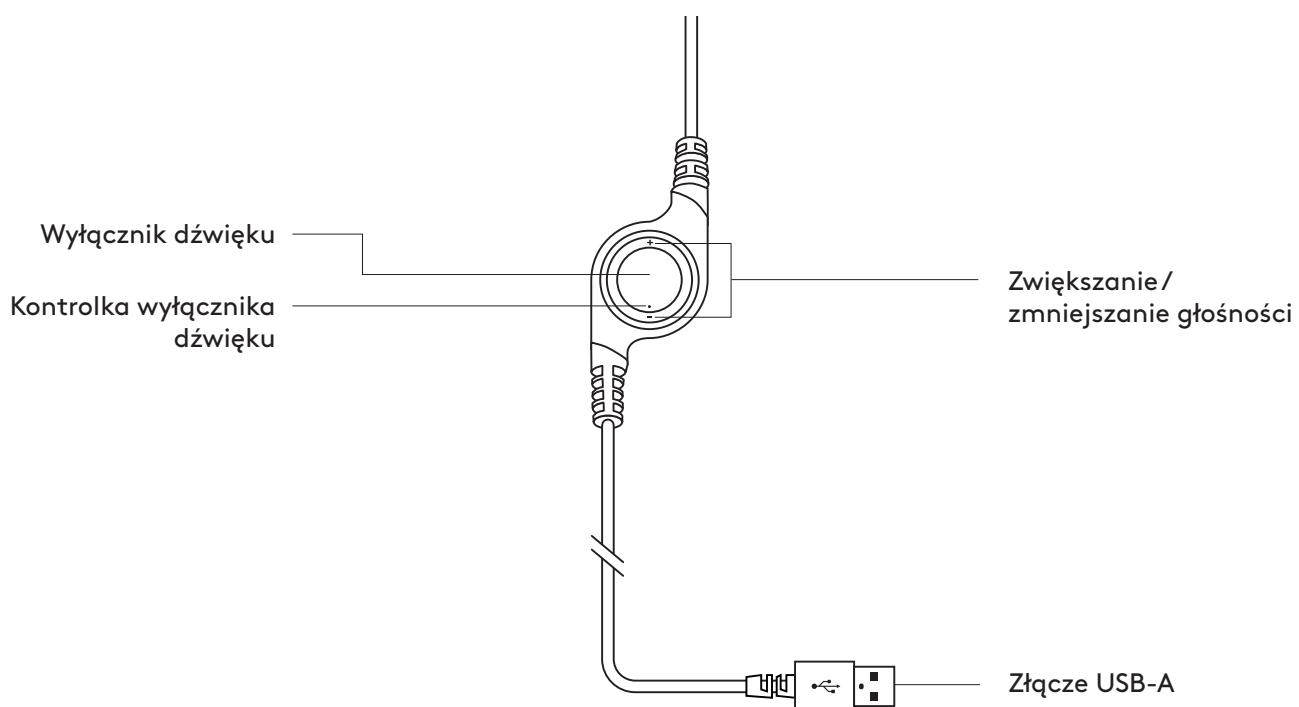

## PODŁĄCZANIE ZESTAWU SŁUCHAWKOWEGO

Podłącz złącze USB-A do portu USB komputera.

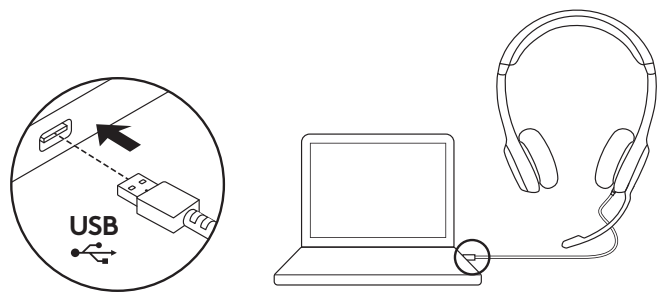

## DOPASOWYWANIE ZESTAWU SŁUCHAWKOWEGO

1. Aby wyregulować rozmiar zestawu słuchawkowego, przesuwaj patyk w górę lub w dół do momentu wygodnego dopasowania.
2. Przesuwaj wysięgnik mikrofonu w górę i w dół do momentu, aż zrówna się z ustami, aby zapewnić lepsze przechwytywanie dźwięku.
3. Gdy wysięgnik mikrofonu nie jest używany, wystarczy go odsunąć.

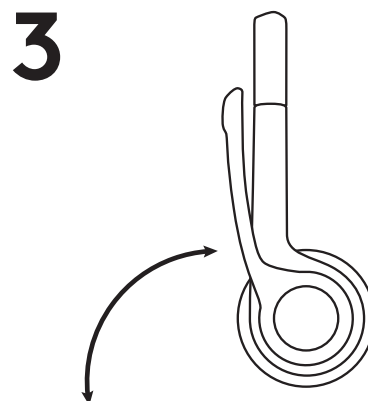
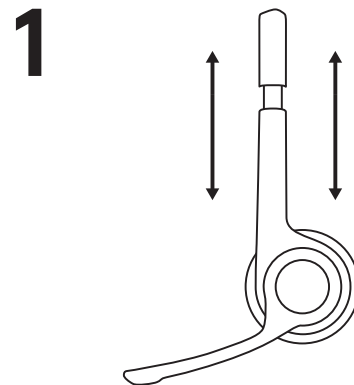

## STEROWANIE

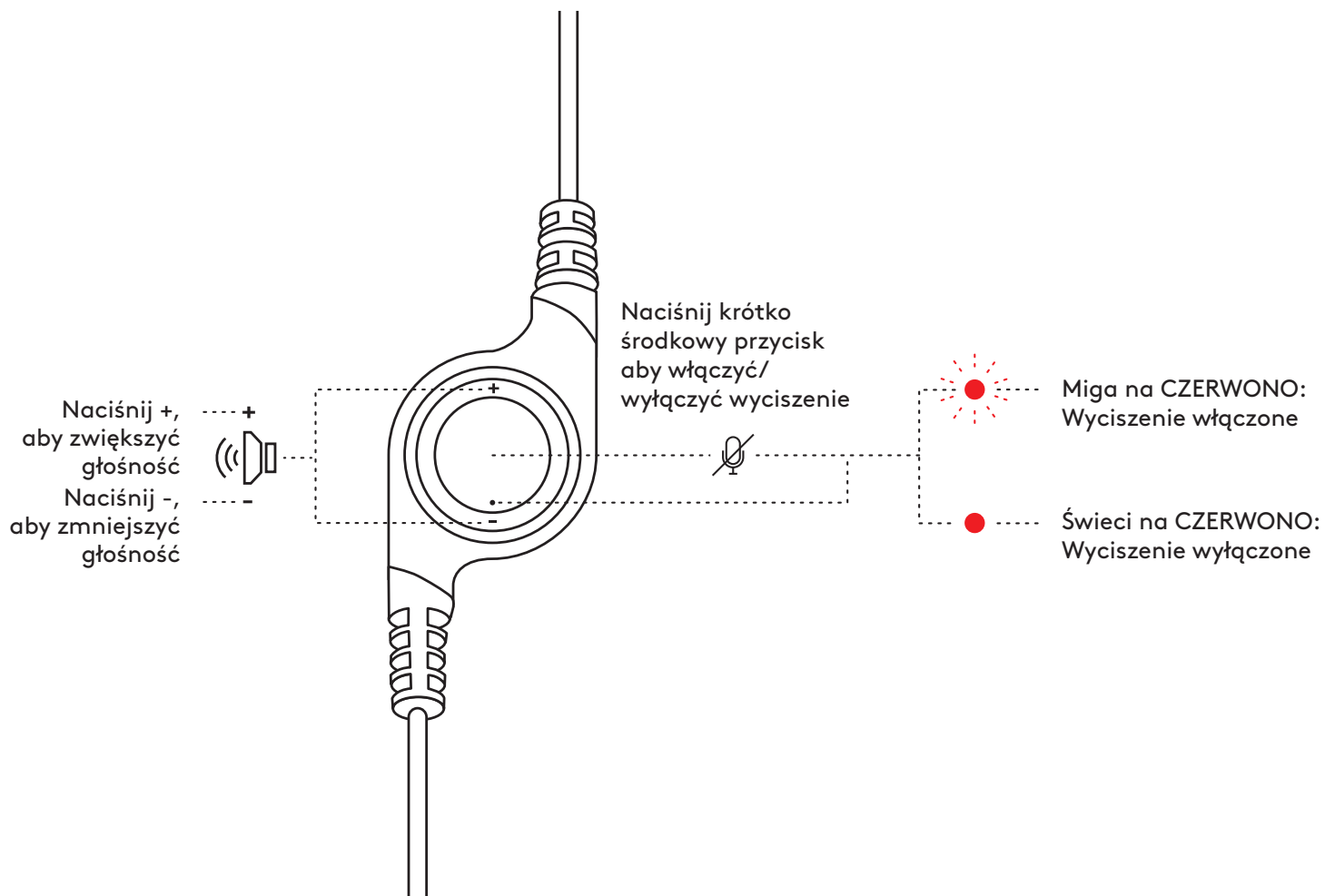

[www.logitech.com/support/H390](http://www.logitech.com/support/H390)



## A TERMÉK ISMERTETÉSE

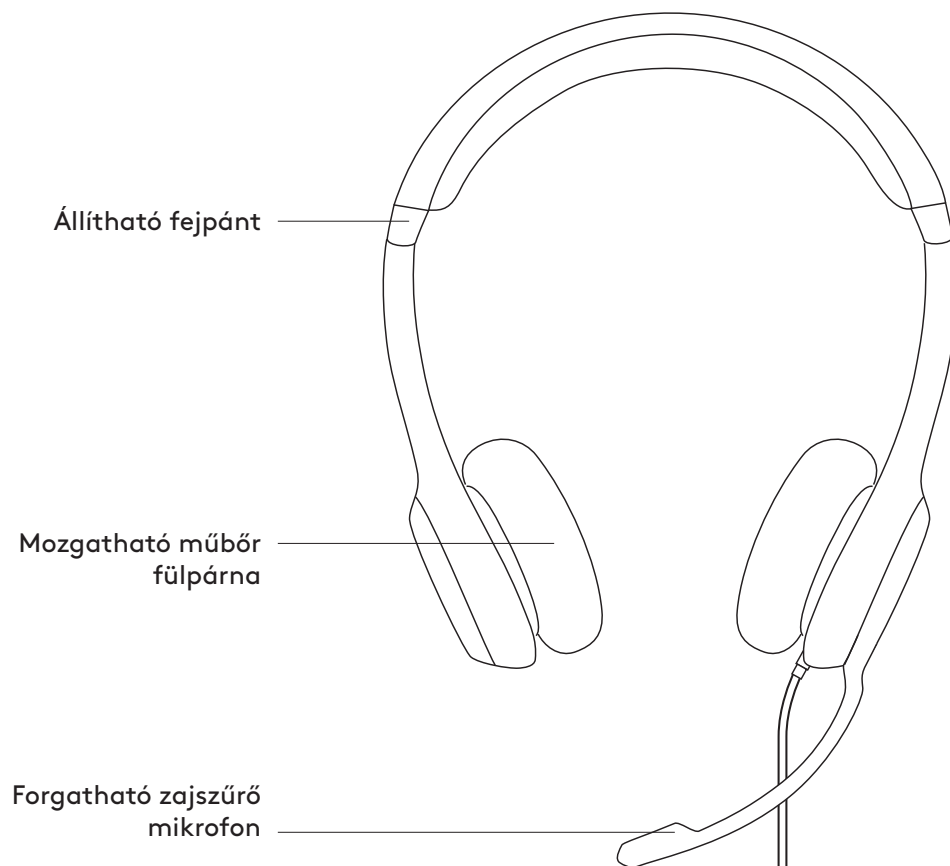

## VEZETÉKBE ÉPÍTETT VEZÉRLŐ

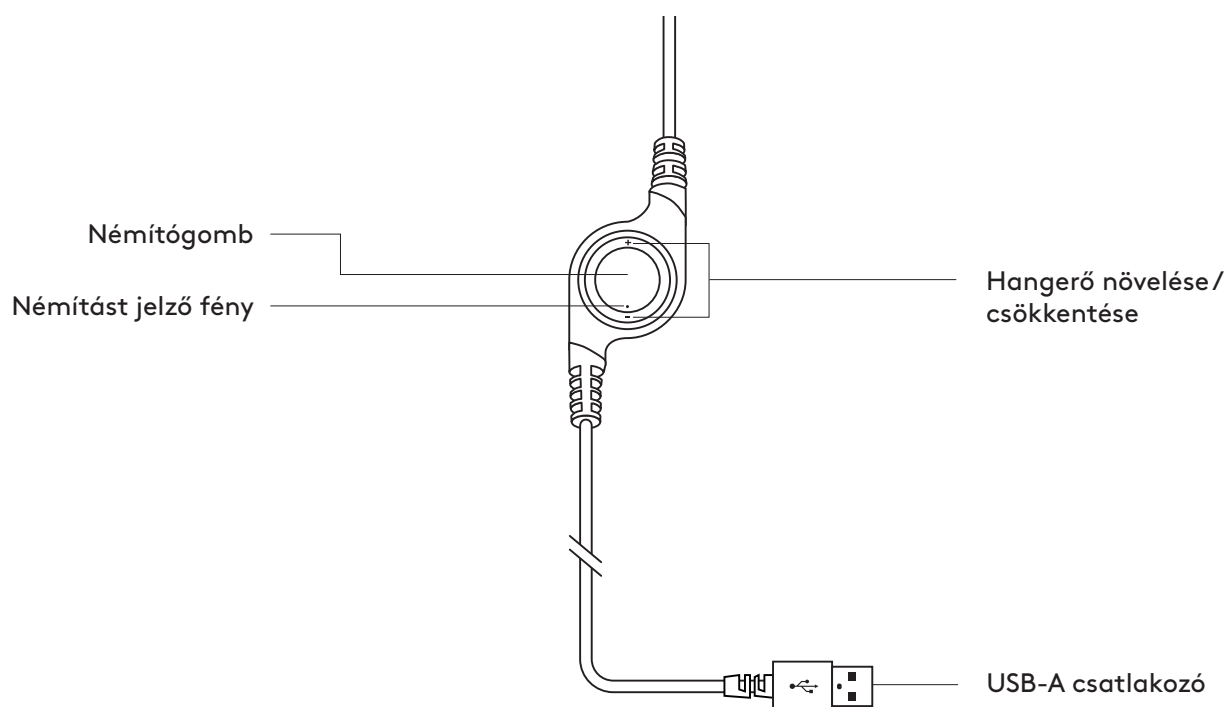

## A MIKROFONOS FEJHALLGATÓ CSATLAKOZTATÁSA

Dugja az USB-A csatlakozót a számítógép USB-portjába.

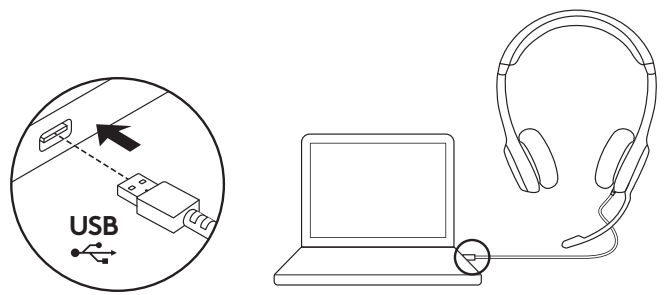

## A MIKROFONOS FEJHALLGATÓ MÉRETRE ÁLLÍTÁSA

1. A mikrofonos fejhallgató méretének beállításához mozgassa fel-le a fejpántot, amíg az kényelmes nem lesz.
2. A jobb hangérzékeléshez mozgassa fel-le a mikrofonkart, amíg a szája elé nem kerül.
3. A mikrofonkar felhajtható, amikor éppen nem használja.

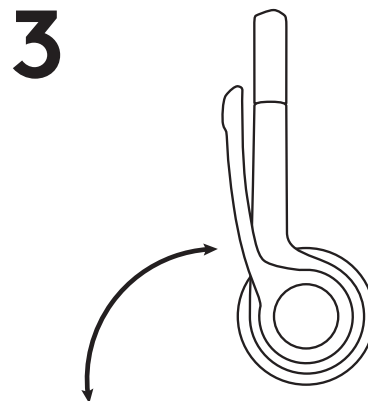
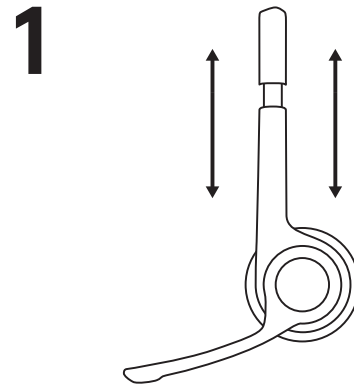

## KEZELŐSZERVEK

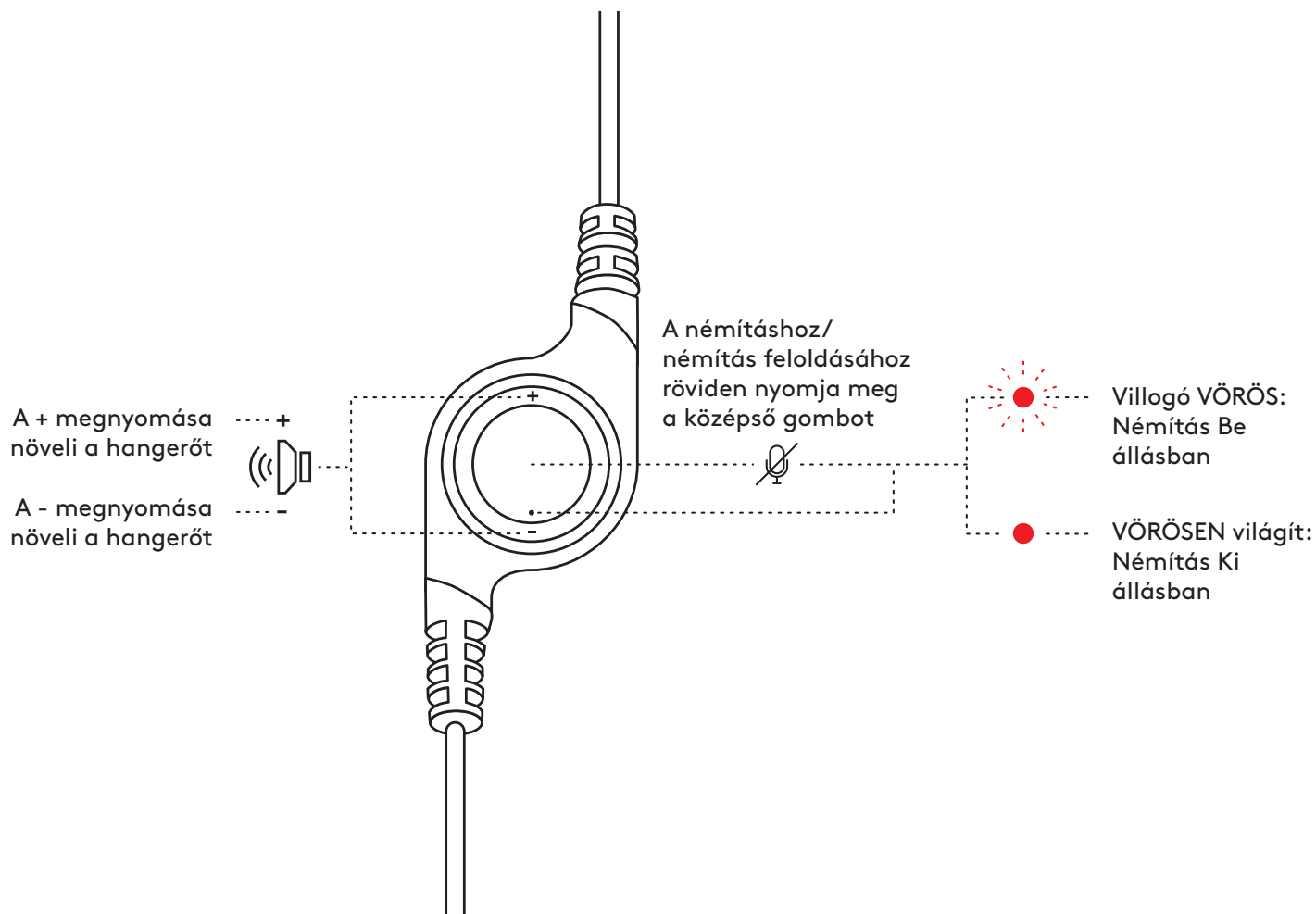

[www.logitech.com/support/H390](http://www.logitech.com/support/H390)

## POPIS PRODUKTU

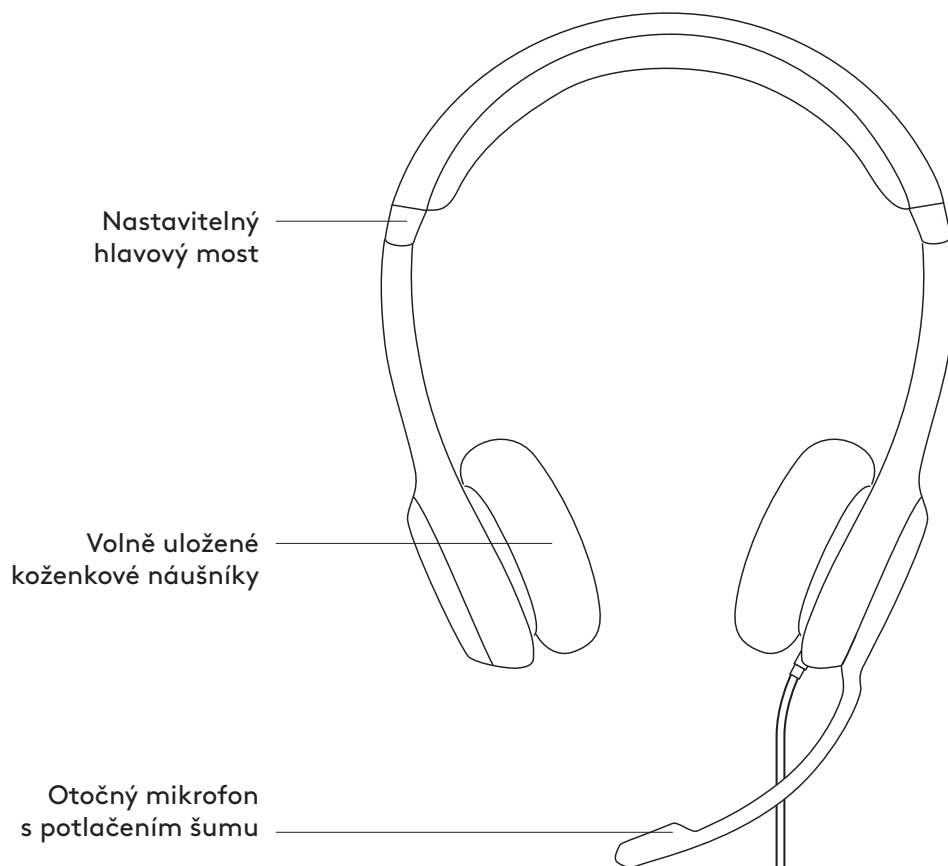

## INTEGROVANÝ OVLADAČ

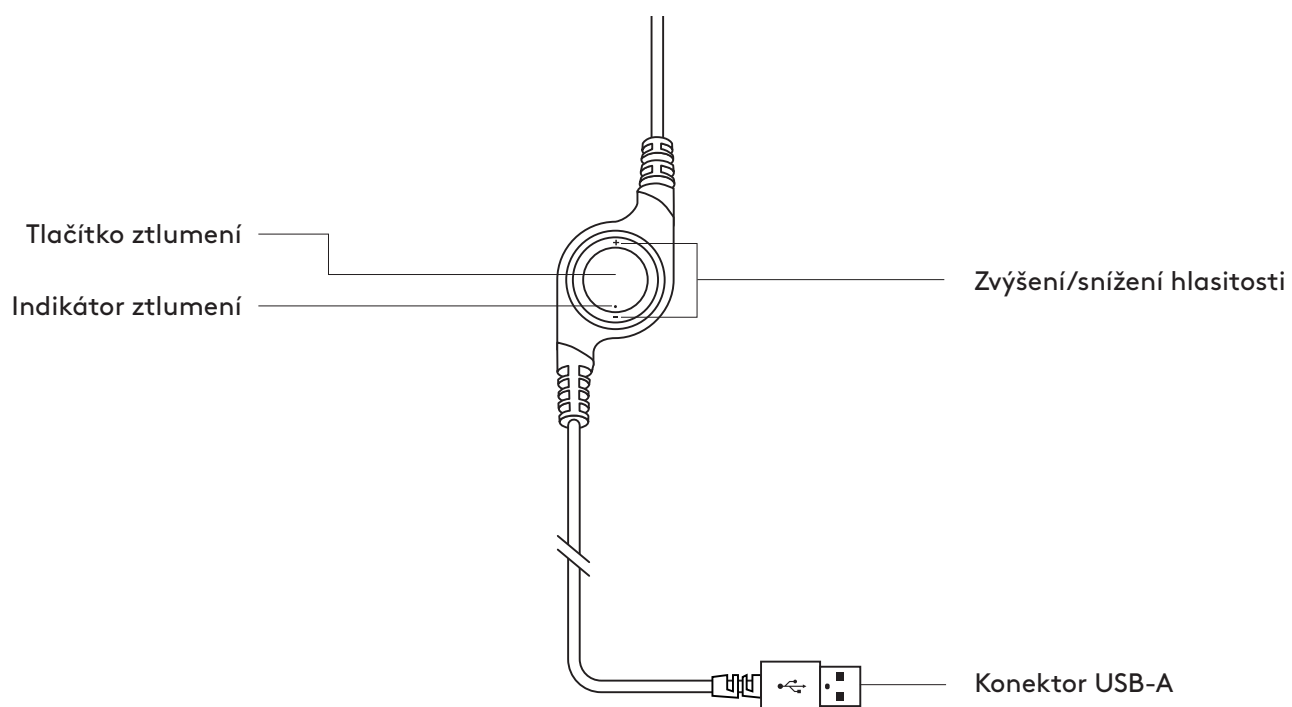

## PŘIPOJENÍ NÁHLAVNÍ SOUPRAVY

Připojte konektor USB-A k portu USB v počítači.

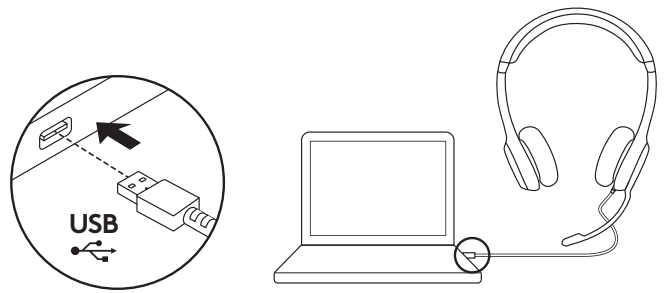

## USAZENÍ NÁHLAVNÍ SOUPRAVY

1. Nastavte si velikost náhlavní soupravy posouváním hlavového mostu nahoru a dolů, dokud vám pohodlně nepadne.
2. Nastavte si držák s mikrofonem pohyby nahoru nebo dolů tak, aby byl v rovině s vašimi ústy pro lepší snímání hlasu.
3. Když držák mikrofonu nepoužíváte, stačí jej odklopit stranou.

1

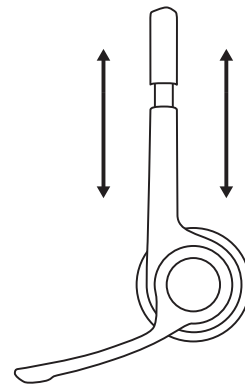

2

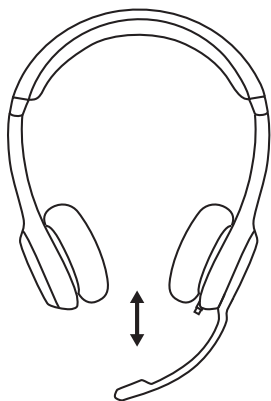

3

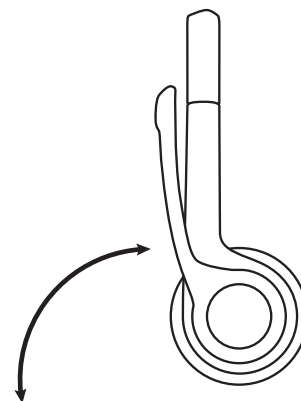

## OVLÁDACÍ PRVKY

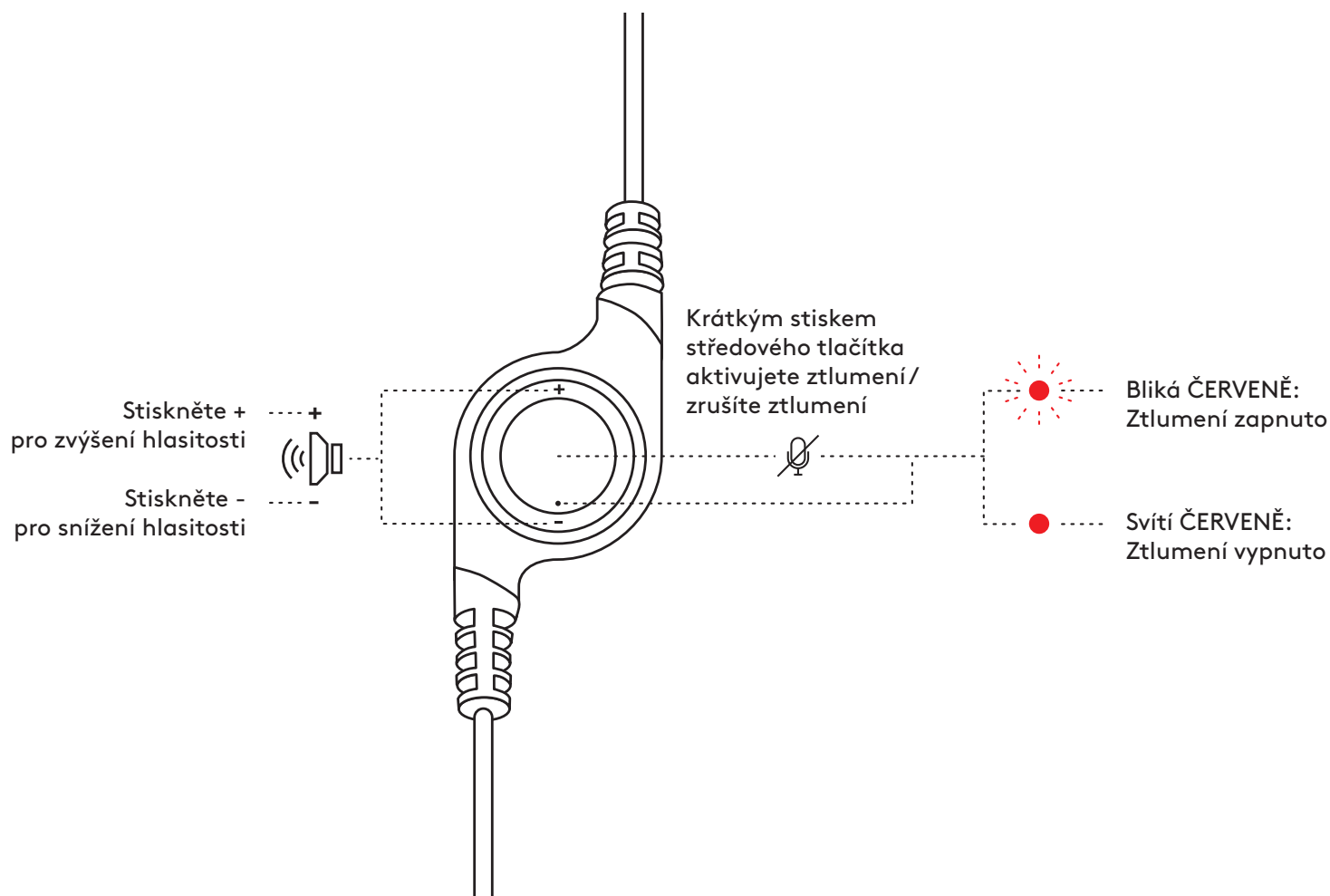

[www.logitech.com/support/H390](http://www.logitech.com/support/H390)

## POPIS PRODUKTU

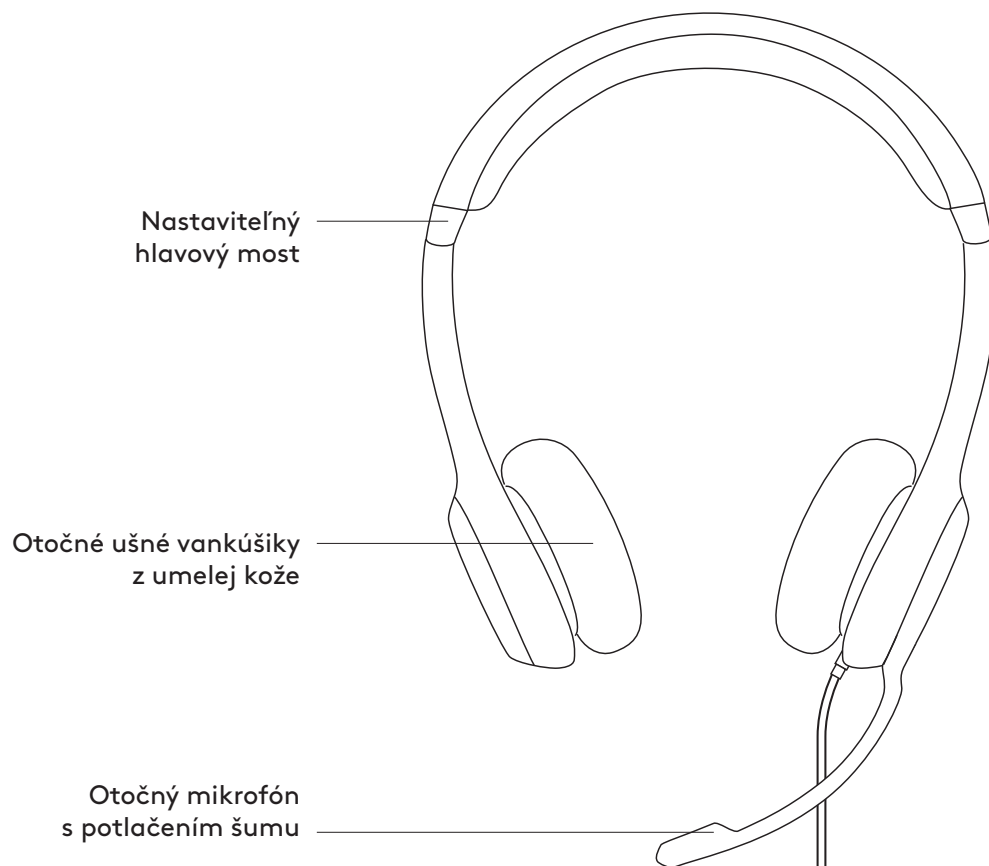

## INTEGROVANÝ OVLÁDAČ

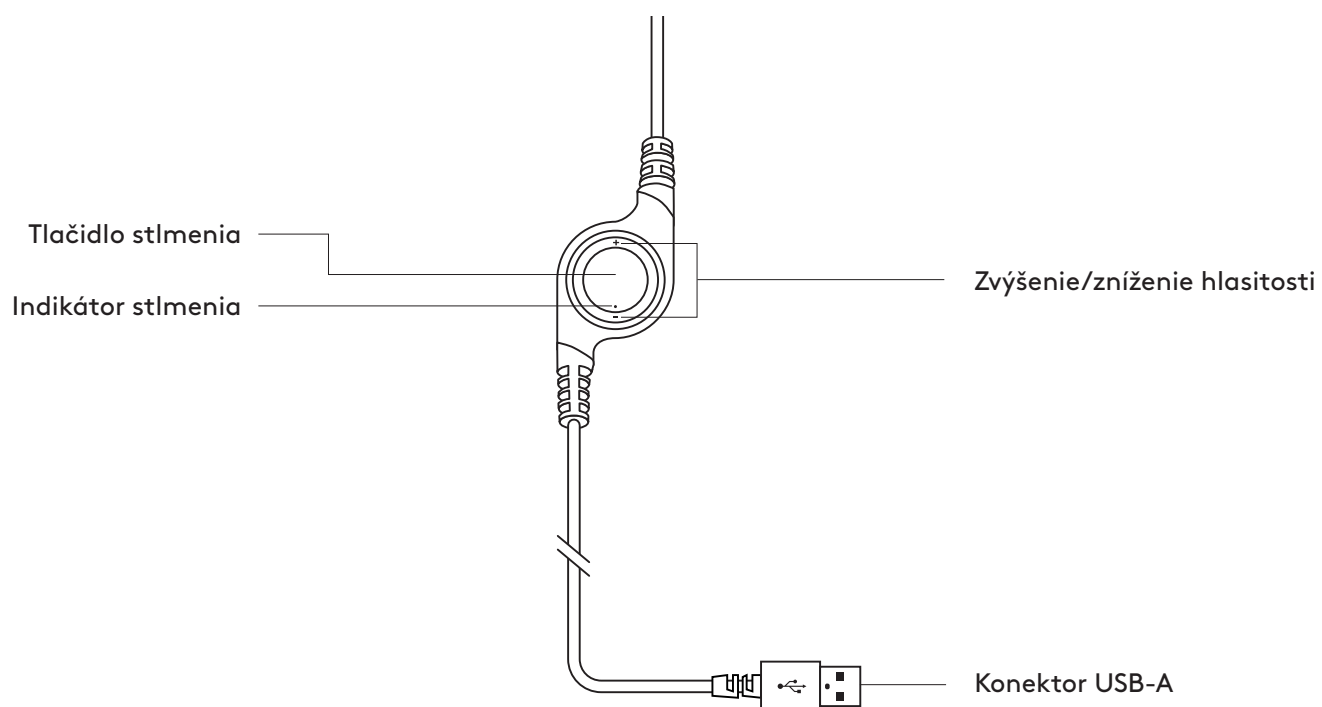

## PRIPOJENIE NÁHLAVNEJ SÚPRAVY

Pripojte konektor USB-A k portu USB v počítači.

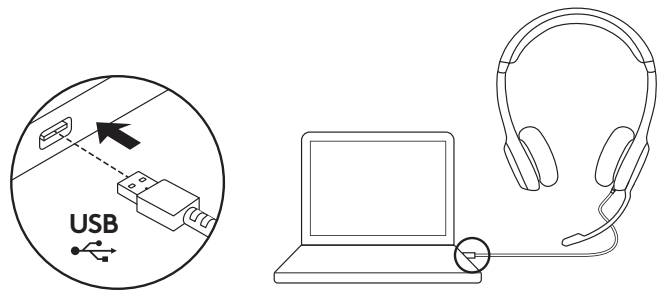

## USADENIE NÁHLAVNEJ SÚPRAVY

1. Nastavte si veľkosť náhlavnej súpravy posúvaním hlavového mosta nahor a nadol, kým vám nebude pohodlne sedieť.
2. Nastavte si držiak s mikrofónom pohybmi nahor alebo nadol tak, aby bol v rovine s vašimi ústami a mohol tak lepšie snímať hlas.
3. Keď držiak mikrofónu nepoužívate, stačí ho odklopiť nabok.

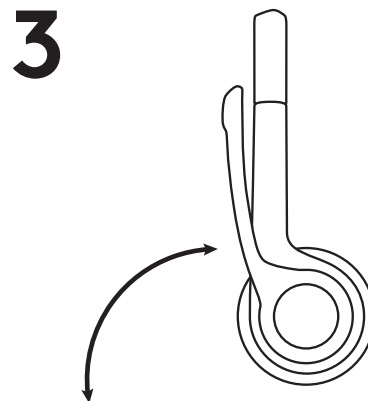
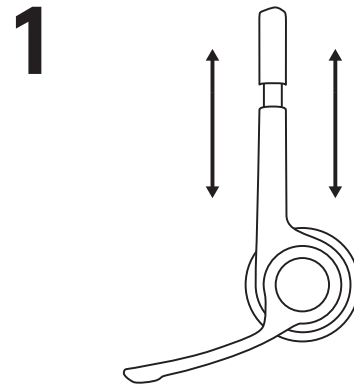



## OVLÁDACIE PRVKY

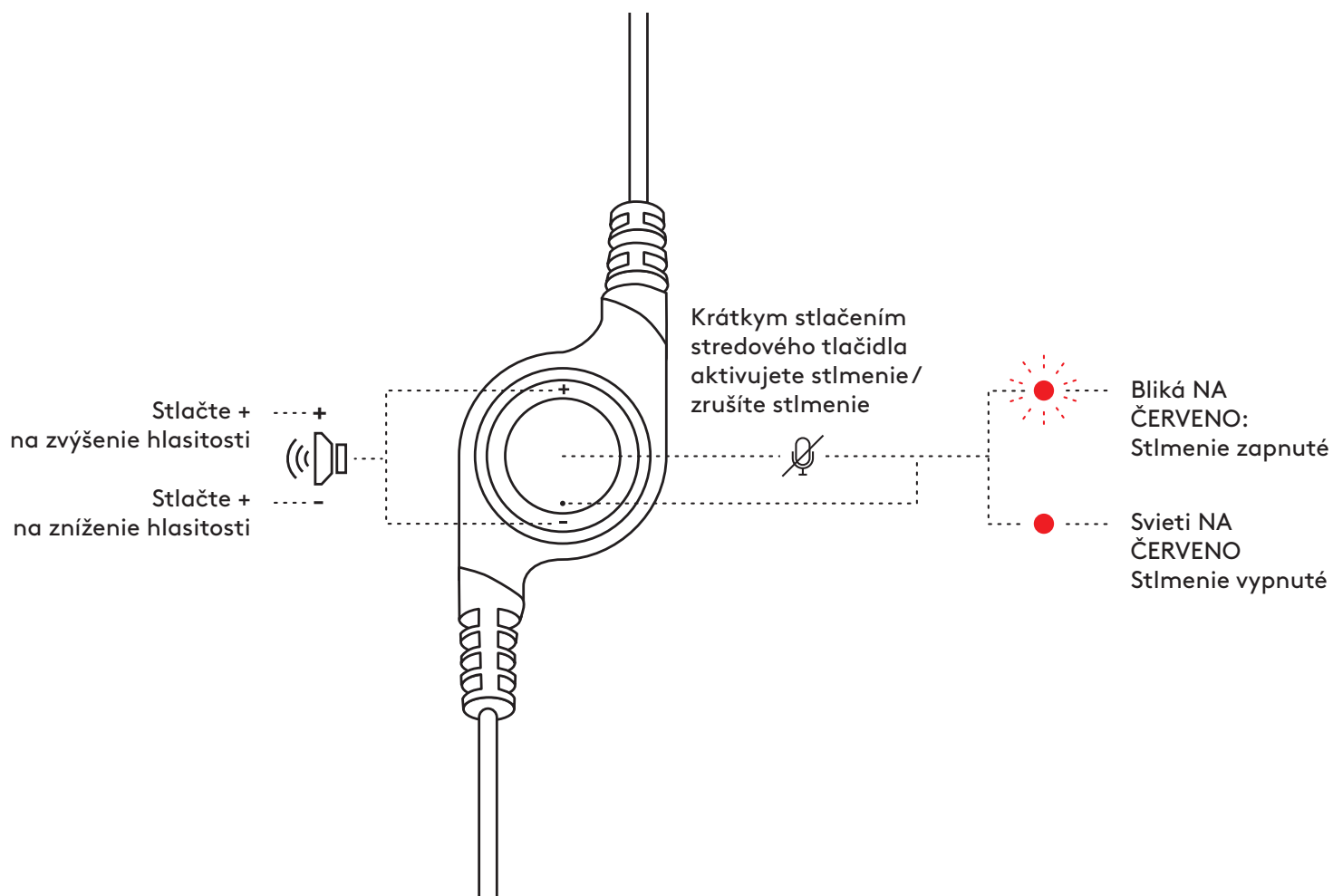

[www.logitech.com/support/H390](http://www.logitech.com/support/H390)

## ОЗНАЙОМЛЕННЯ З ПРОДУКТОМ

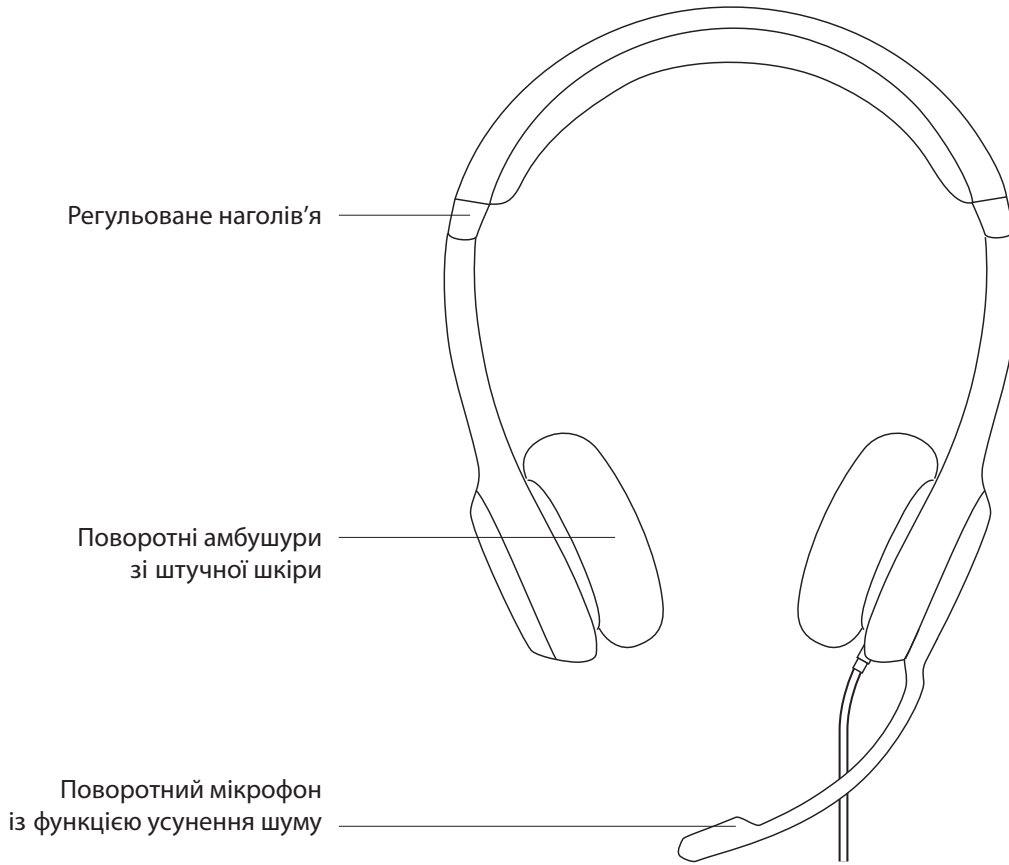

## ВБУДОВАНИЙ КОНТРОЛЕР

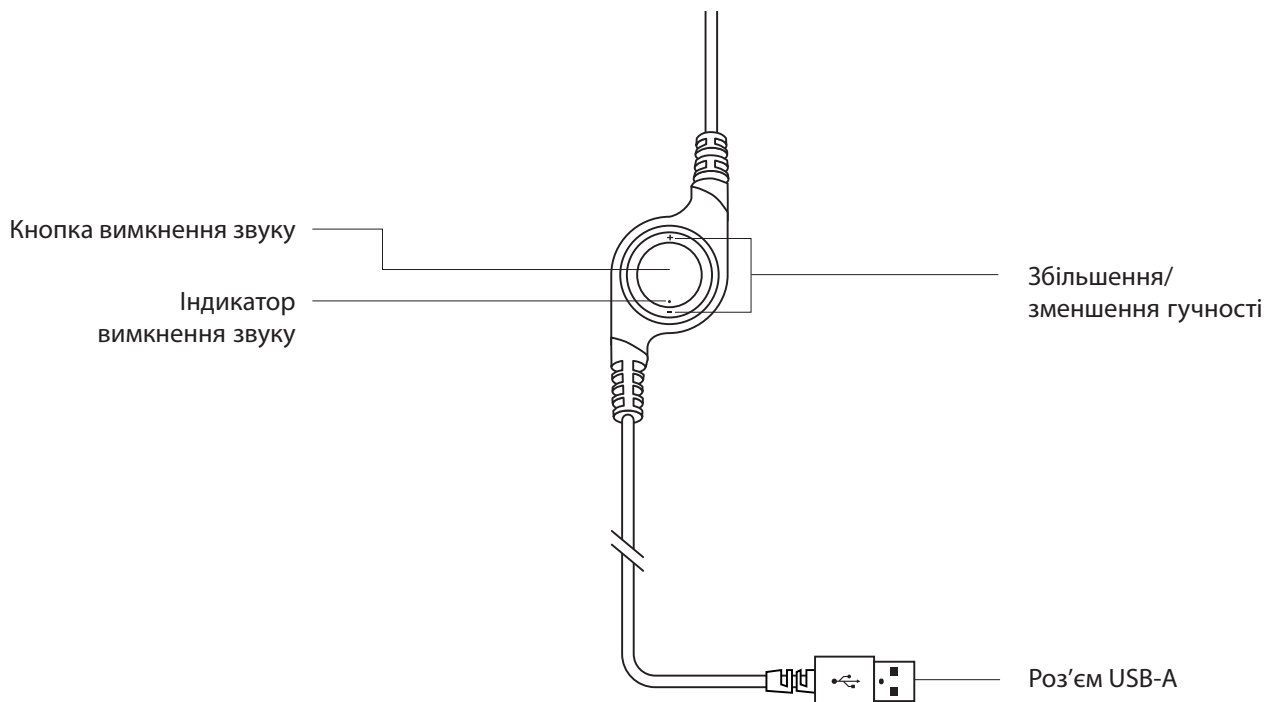

## ПІДКЛЮЧЕННЯ ГАРНІТУРИ

Вставте роз'єм USB-A у USB-порт комп'ютера.

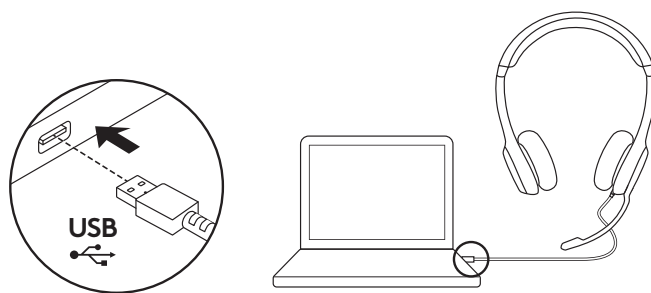

## ПОСАДКА ГАРНІТУРИ

1. Щоб відрегулювати висоту наголів'я, рухайте його вгору вниз, поки гарнітура не сяде як треба.
2. Переміщуйте штатив мікрофона вгору-вниз, поки він не набуде положення, в якому ваш голос передаватиметься максимально чітко.
3. Коли мікрофон не використовується, його можна повернути вбік.

1

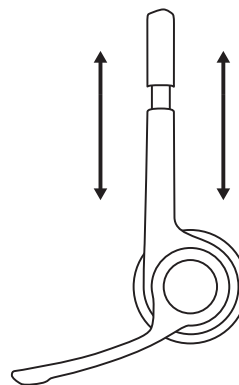

2

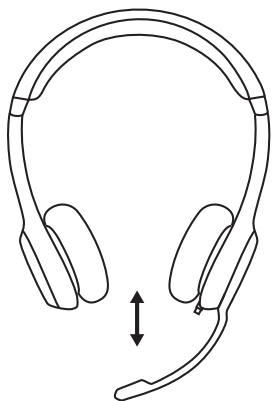

3

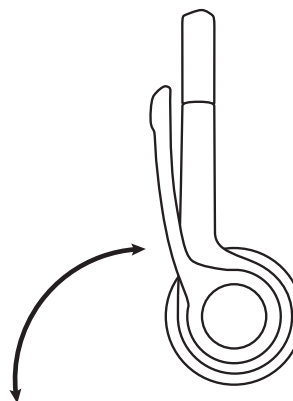

## ЕЛЕМЕНТИ КЕРУВАННЯ

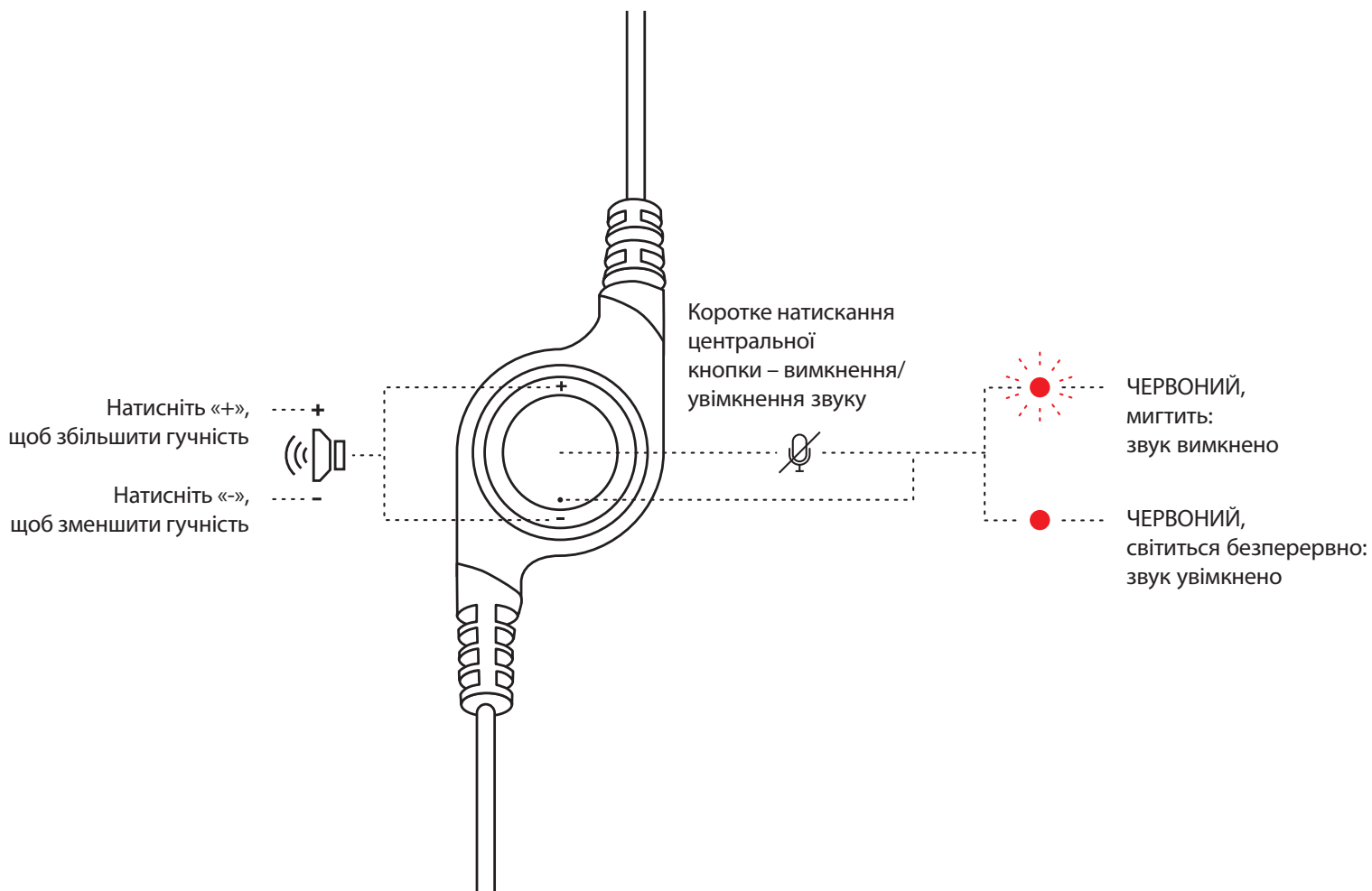

[www.logitech.com/support/H390](http://www.logitech.com/support/H390)

## TOOTE TUTVUSTUS

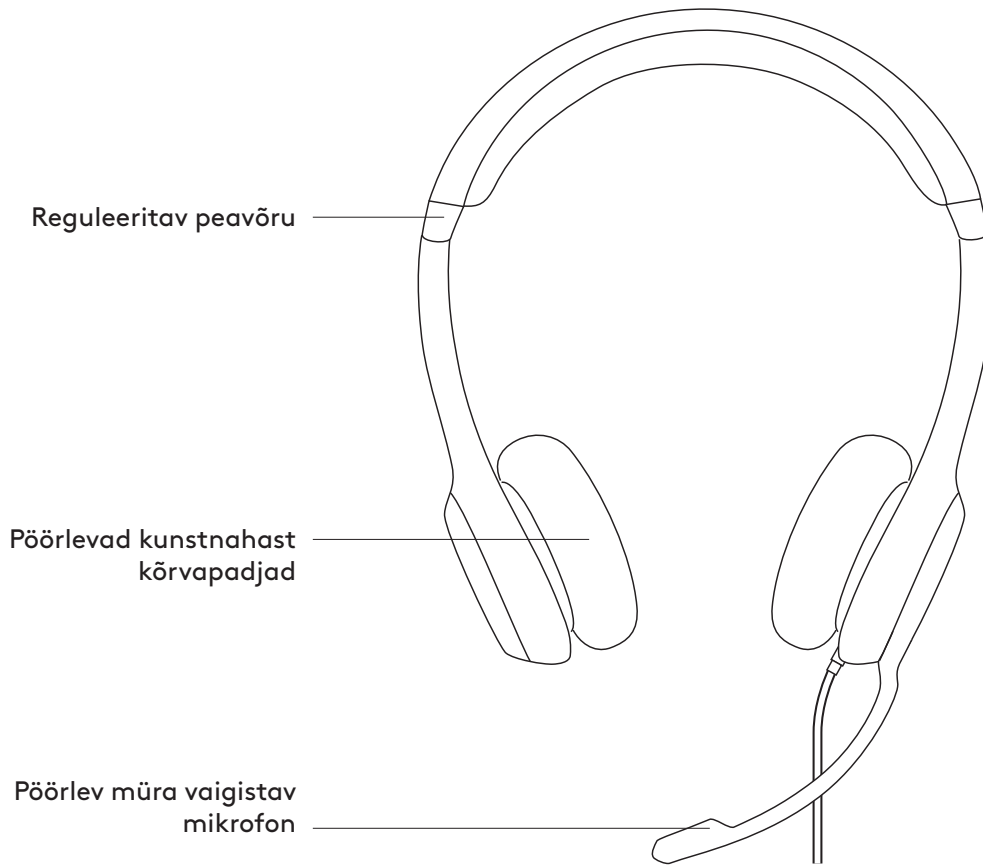

## JUHTMEL ASUV KONTROLLER

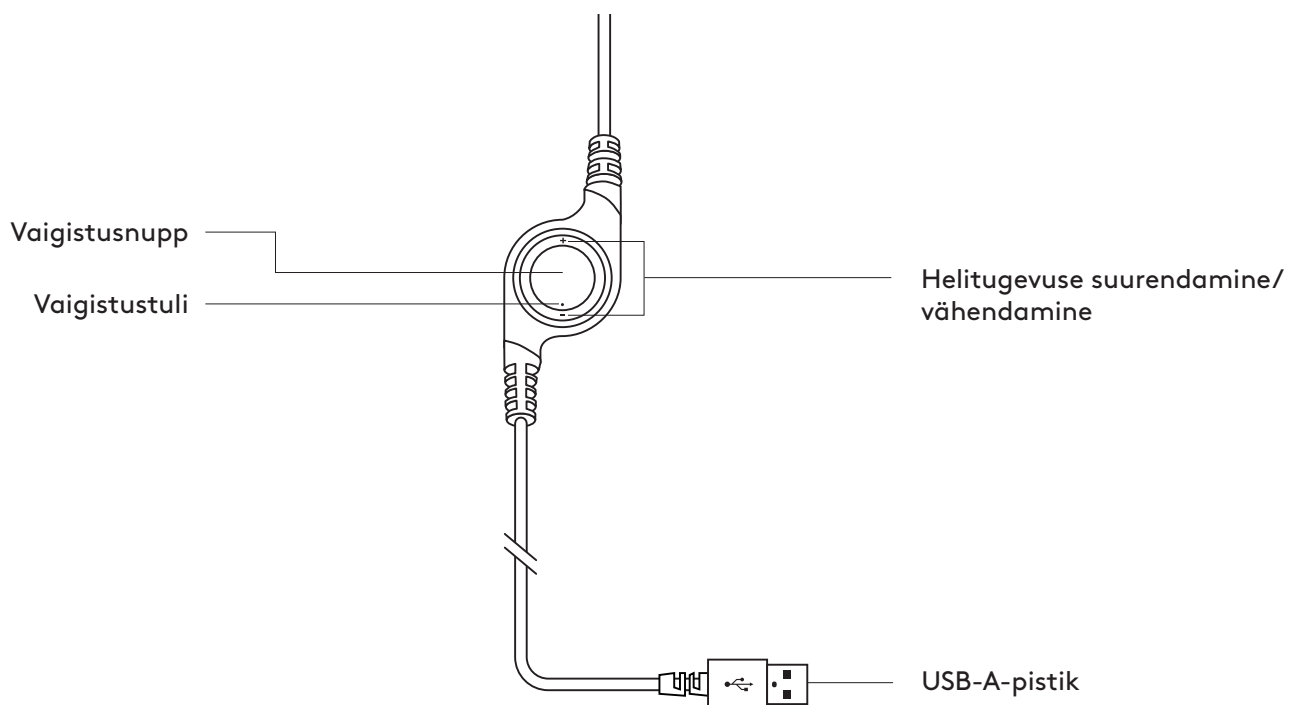

## PEAKOMPLEKTI ÜHENDAMINE

Ühendage USB-A-konnektor arvuti USB-porti.

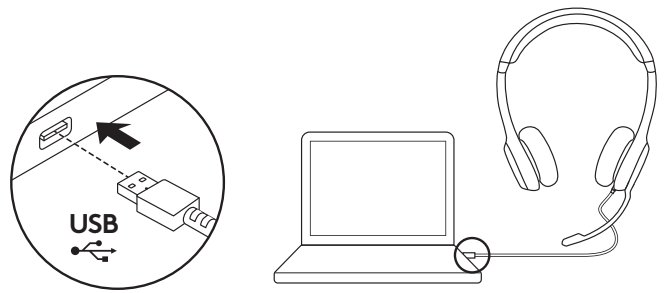

## PEAKOMPLEKTI PÄHESOBIVUS

1. Peakomplekti suuruse reguleerimiseks liigutage seda üles ja alla, kuni leiате mugavaima asendi.
2. Parima häälesalvestuse saavutamiseks liigutage mikrofonivart üles või alla, kuni see on suuga sama kõrgel.
3. Kui te mikrofoni ei kasuta, saate selle eest ära keerata.

1

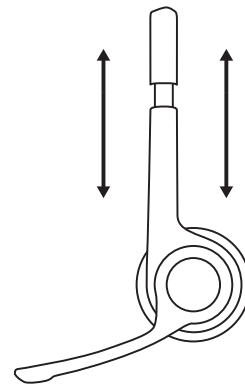

2

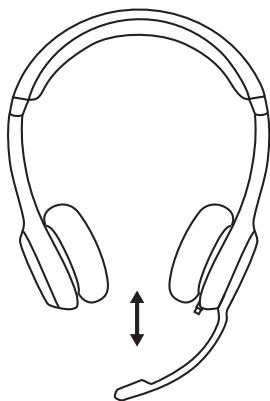

3

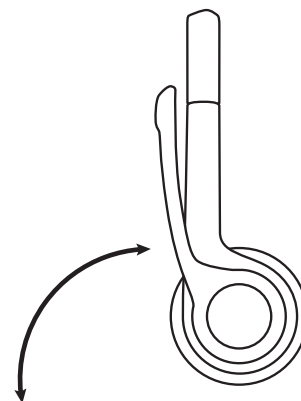

## JUHTELEMENDID

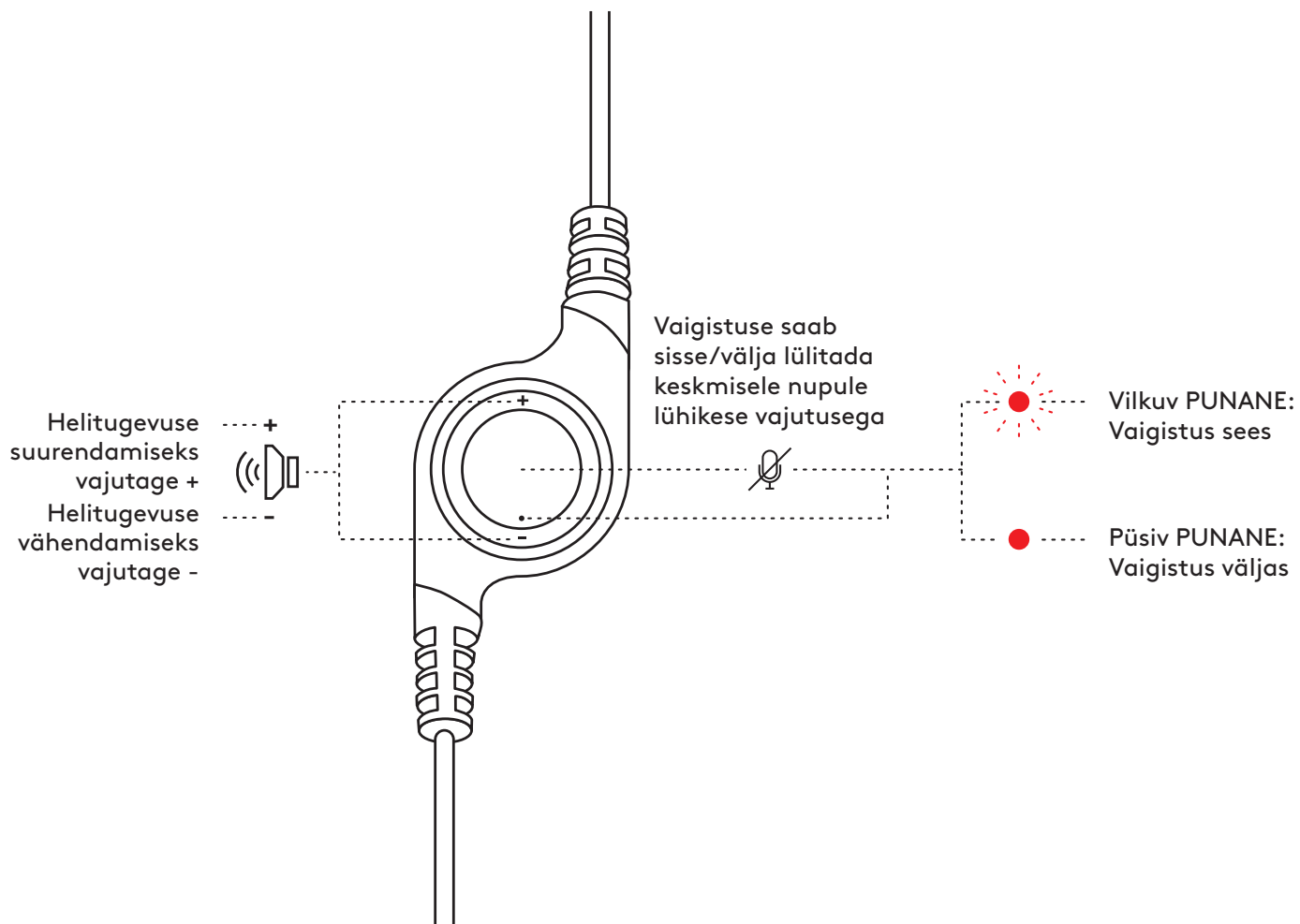

[www.logitech.com/support/H390](http://www.logitech.com/support/H390)

## PĀRZINIET SAVU IERĪCI

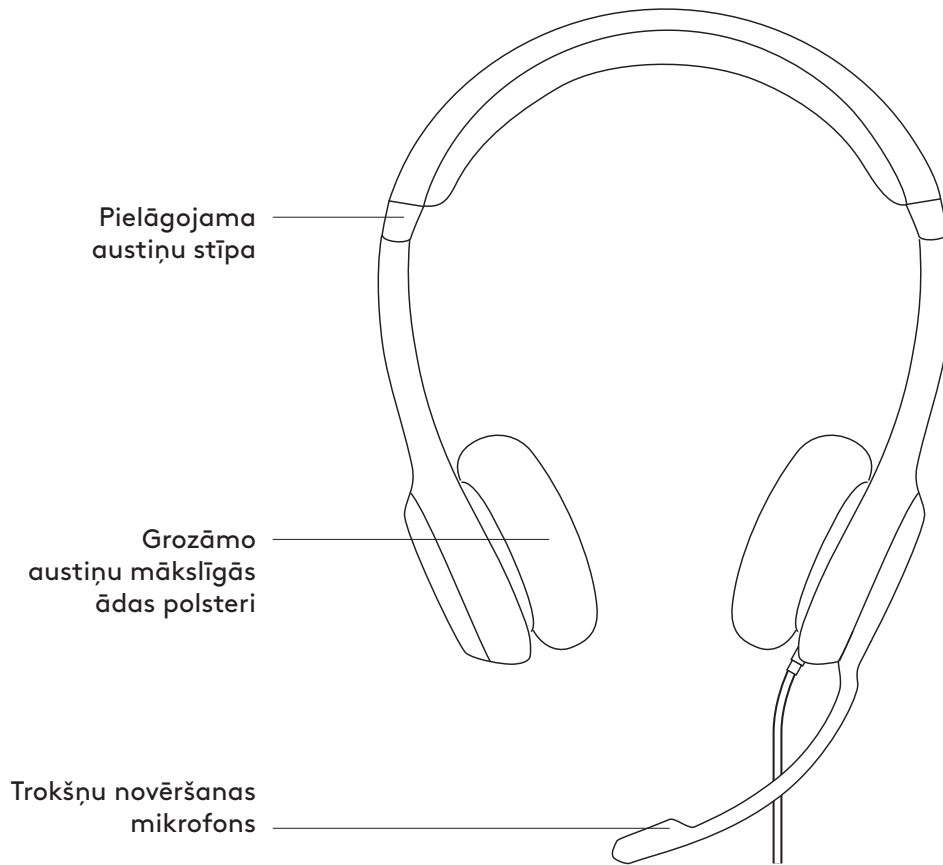

## IEBŪVĒTAS VADĪKLAS

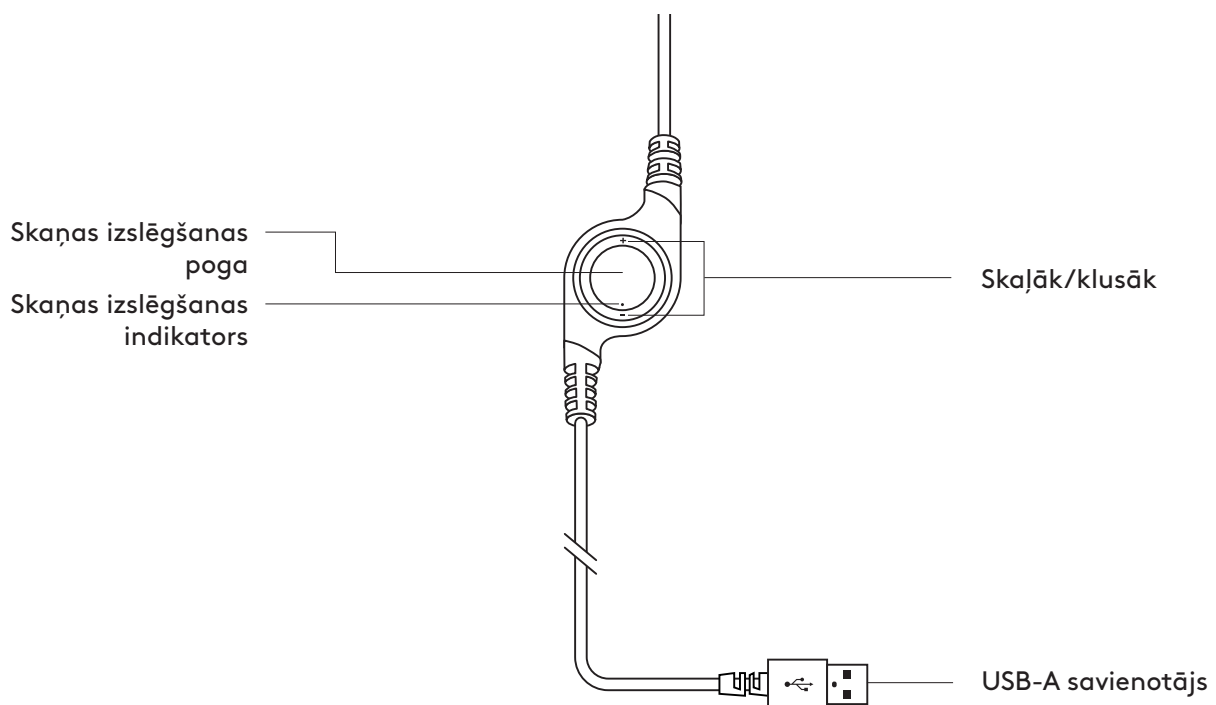



## AUSTIŅU PIEVIENOŠANA

Iespraudiet USB-A savienotāju datora USB pieslēgvietā.

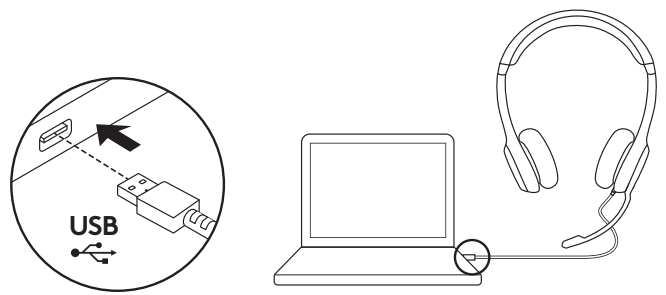

## AUSTIŅU REGULĒŠANA

1. Lai noregulētu ausiņu izmēru, pārvietojiet ausiņu stīpu uz augšu vai leju, līdz tā ērti der uz galvas.
2. Pārvietojiet mikroфона kātiņu uz augšu vai uz leju, līdz tas ir vienā līmenī ar jūsu muti, šādi nodrošinot labāku skaņas uztveršanu.
3. Kad neizmantojat mikrofonu, tā kātiņu var pacelt uz augšu, lai tas netraucētu.

1

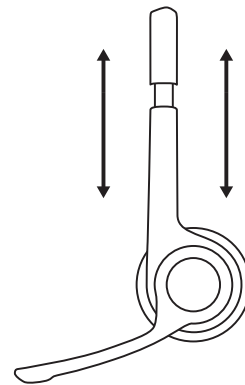

2

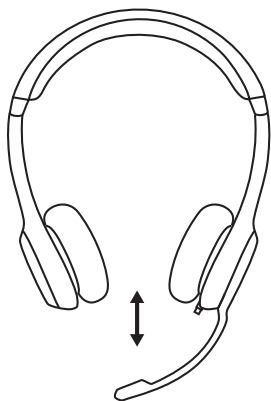

3

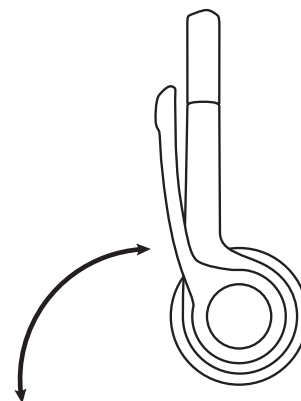

## VADĪKLAS

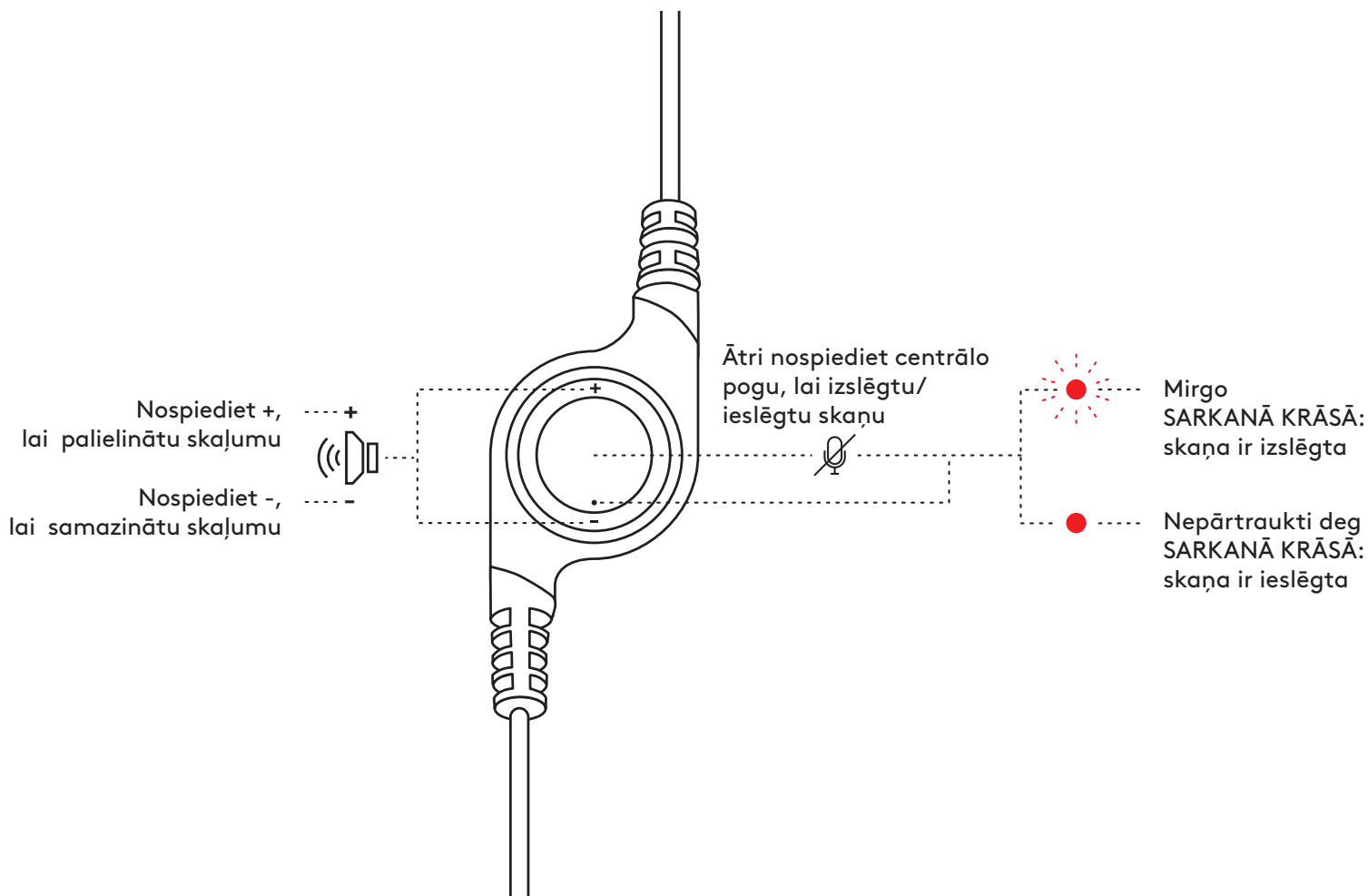

[www.logitech.com/support/H390](http://www.logitech.com/support/H390)

## SUSIPAŽINKITE SU SAVO PRODUKTU

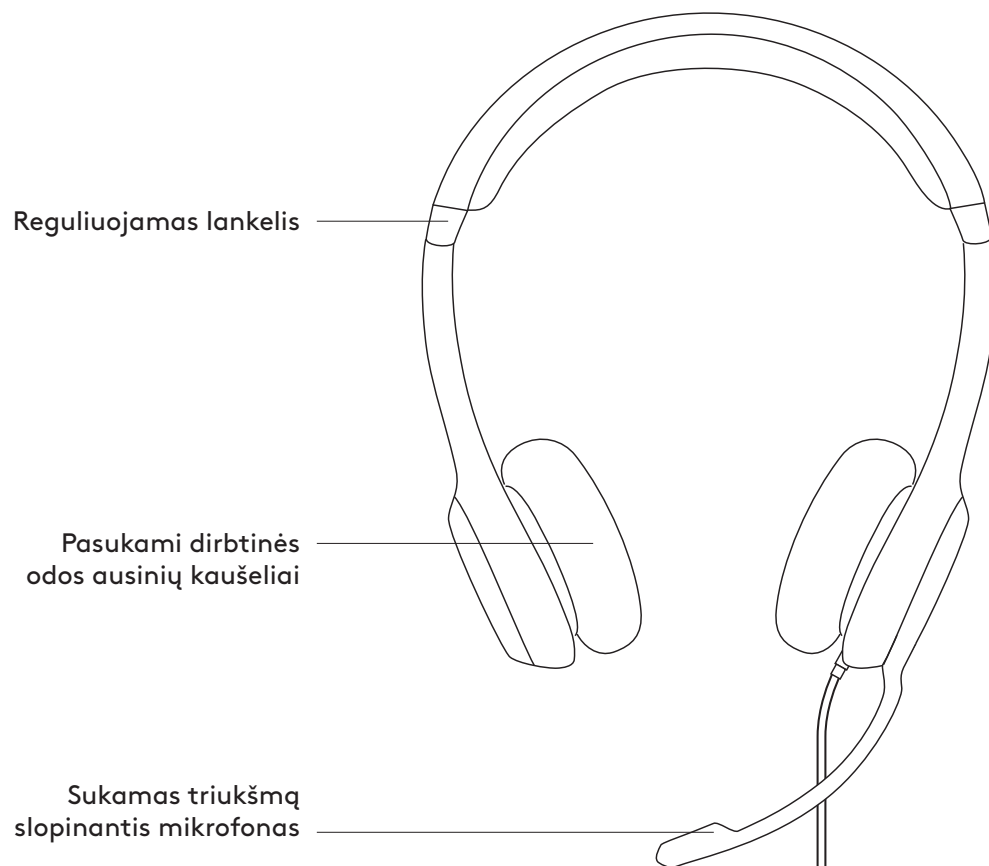

## VIENAEILIS VALDIKLIS

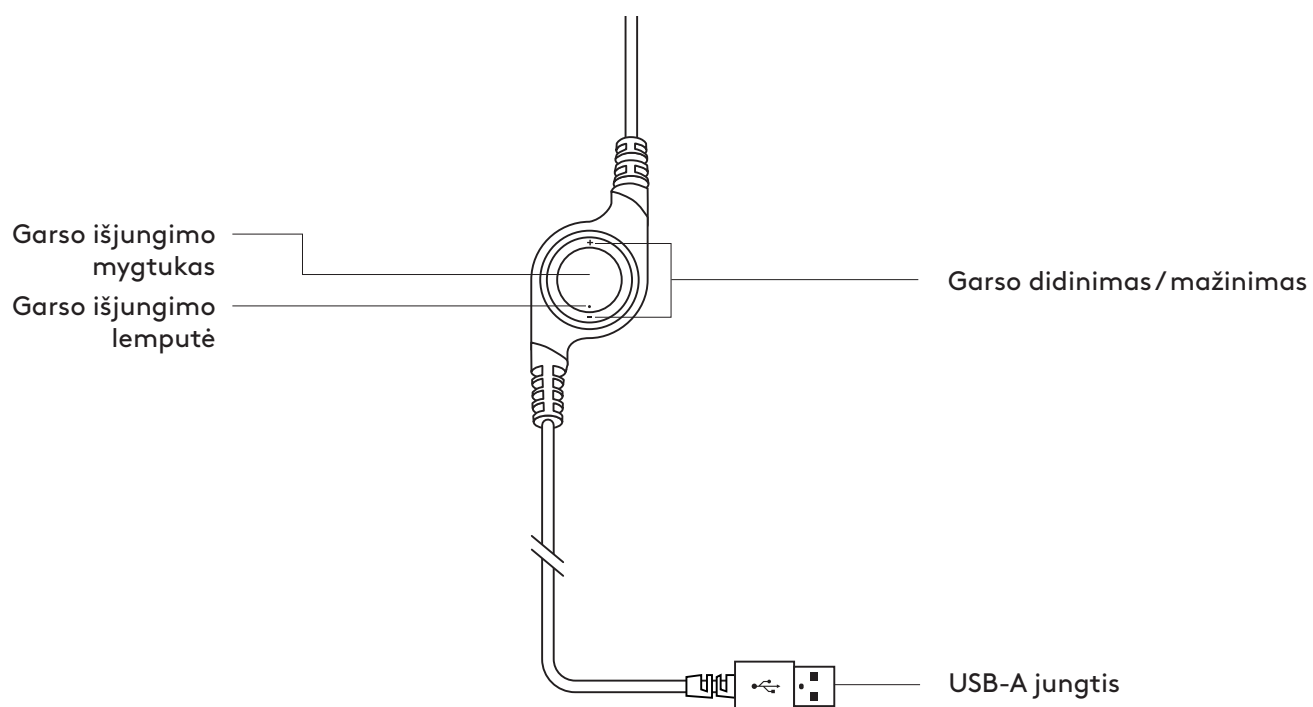

## AUSINIŲ PRIJUNGIMAS

Įkiškite USB-A jungtį į kompiuterio USB prievadą.

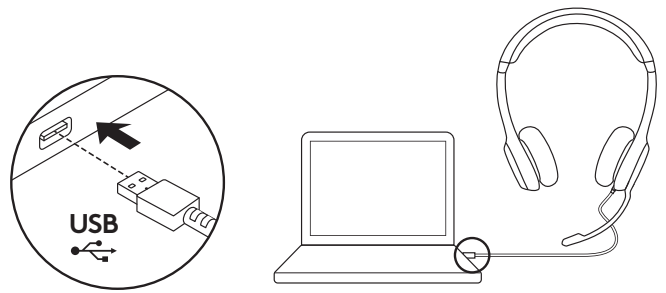

## AUSINIŲ SUREGULIAVIMAS

1. Sureguliuokite galvos juostos dydį judindami galvos juostą į viršų ir apačią, kol patogiai tiks.
2. Judinkite mikrofono strėlę į viršų ar apačią, kol ji bus sulig jūsų burna, kad garsas būtų geriau fiksuojamas.
3. Kai nenaudojate, strėlę nusukite toliau.

**1**

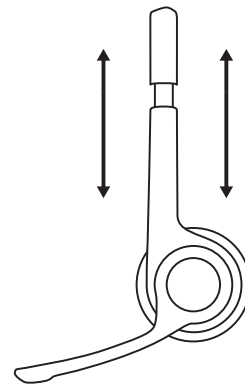

**2**

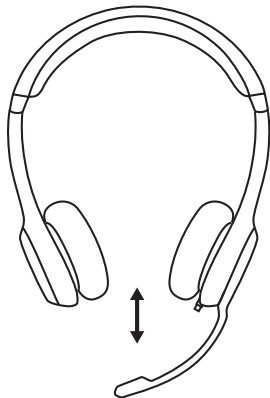

**3**

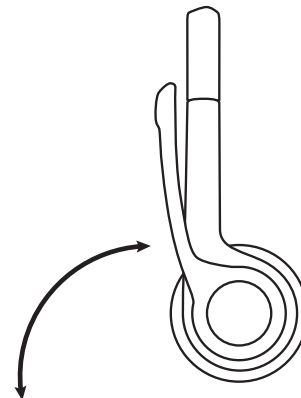

## VALDIKLIAI

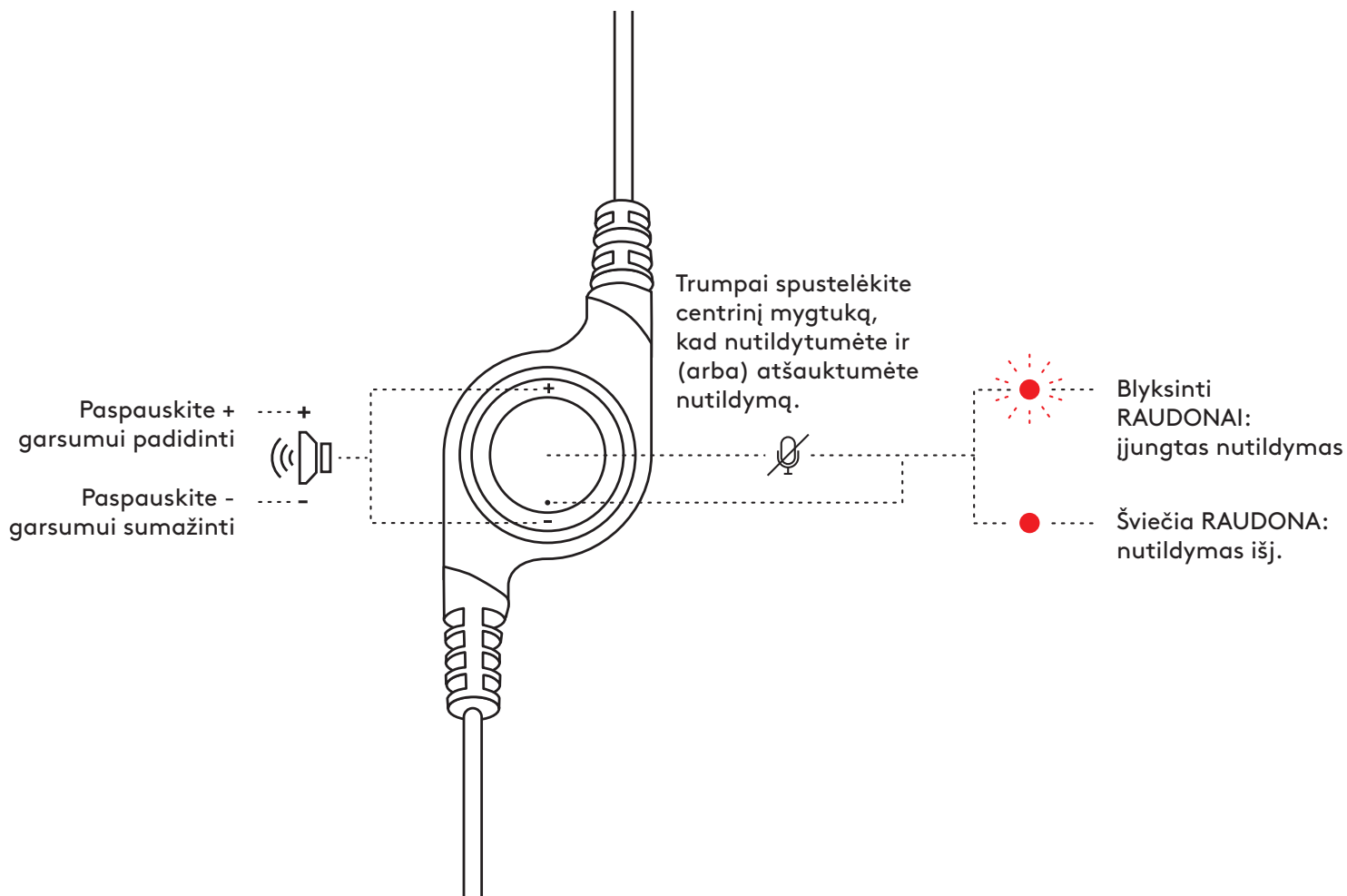

[www.logitech.com/support/H390](http://www.logitech.com/support/H390)

## ЗАПОЗНАЙТЕ СЕ СЪС СВОЯ ПРОДУКТ

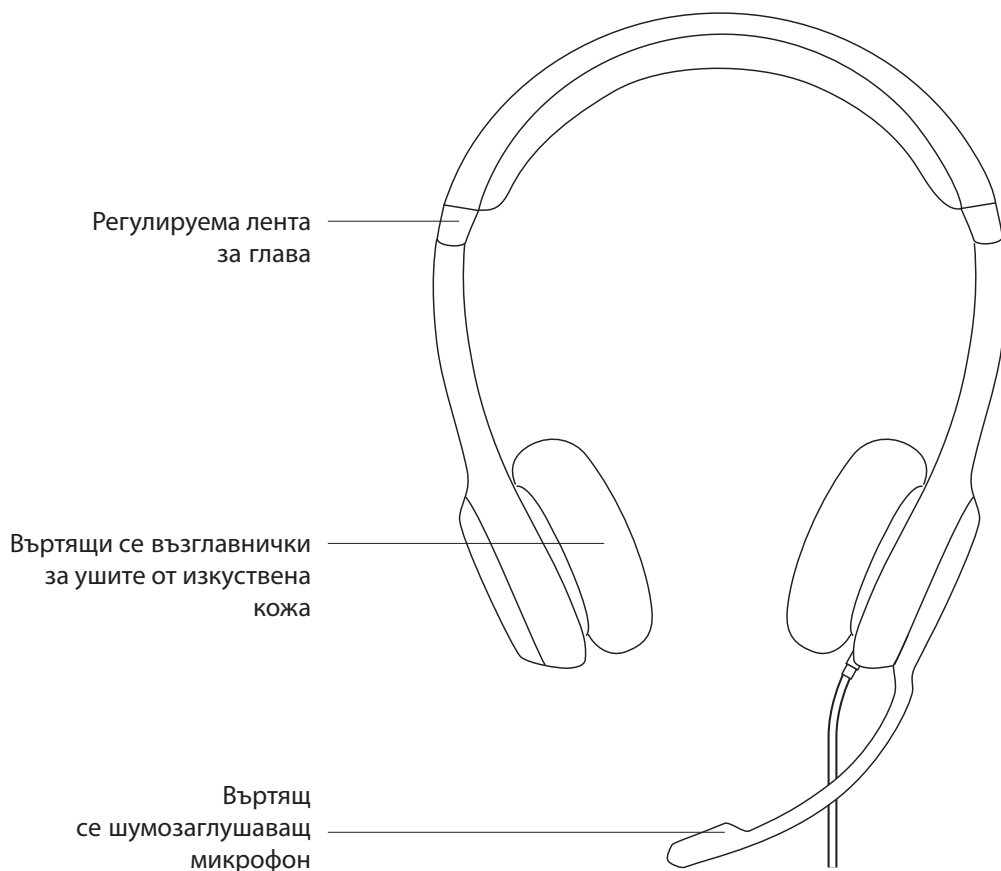

## ВГРАДЕН КОНТРОЛЕР

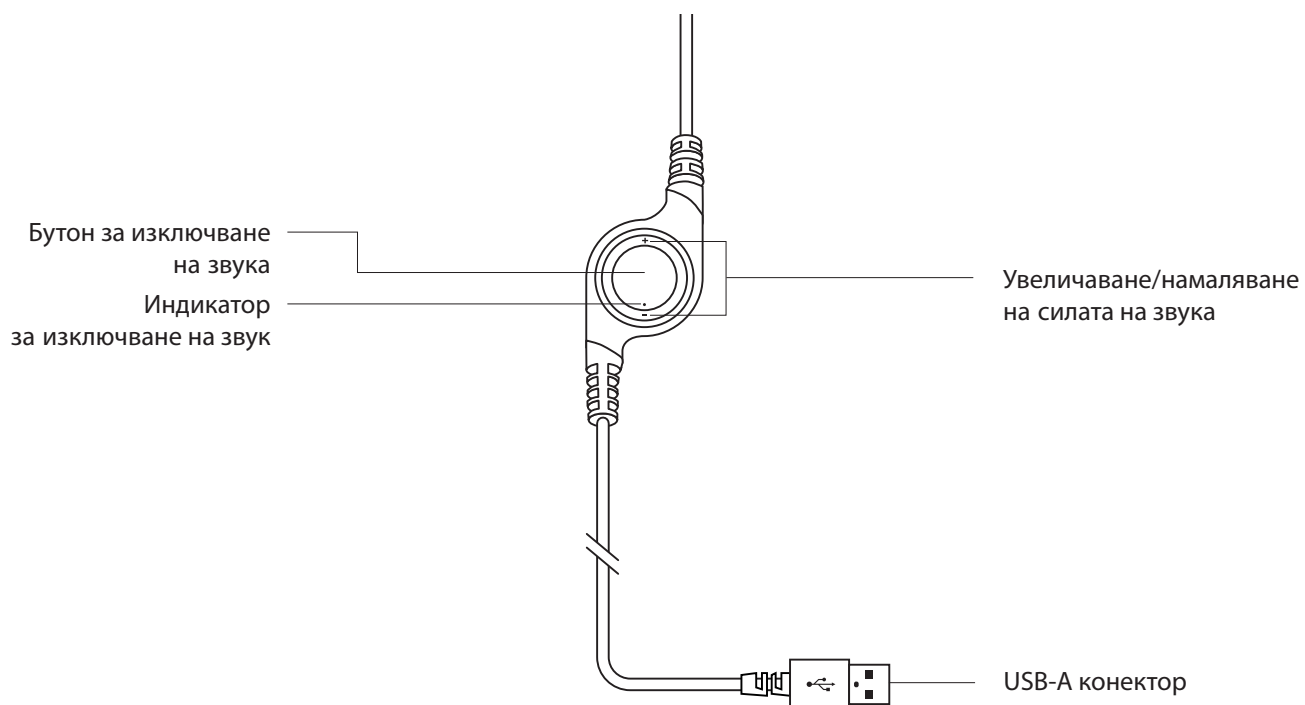

## СВЪРЗВАНЕ НА СЛУШАЛКИТЕ

Включете USB-A конектора към USB порта на компютъра.

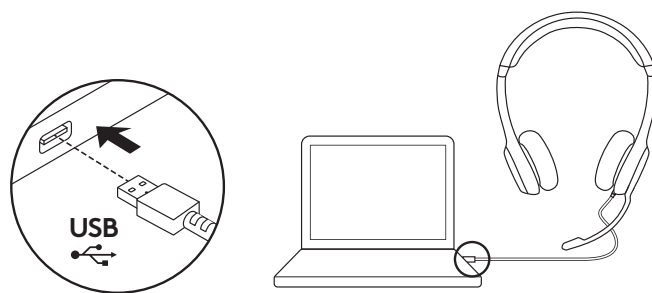

## НАПАСВАНЕ НА СЛУШАЛКИТЕ

1. За да регулирате размера на слушалките, движете лентата за глава нагоре и надолу, докато пасне удобно.
2. Движете стойката на микрофона нагоре или надолу, докато не е на нивото на устата ви за по-добро улавяне на гласа.
3. Когато не се използва, стойката на микрофона може да се прибере.

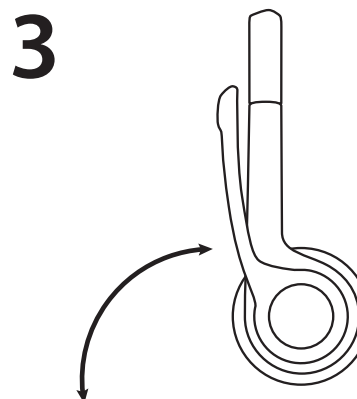
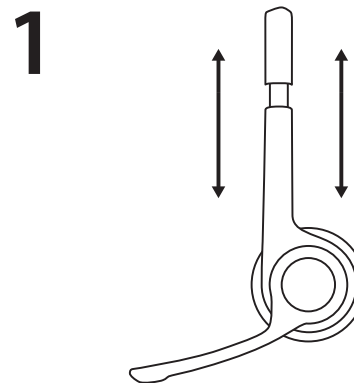

## КОНТРОЛИ

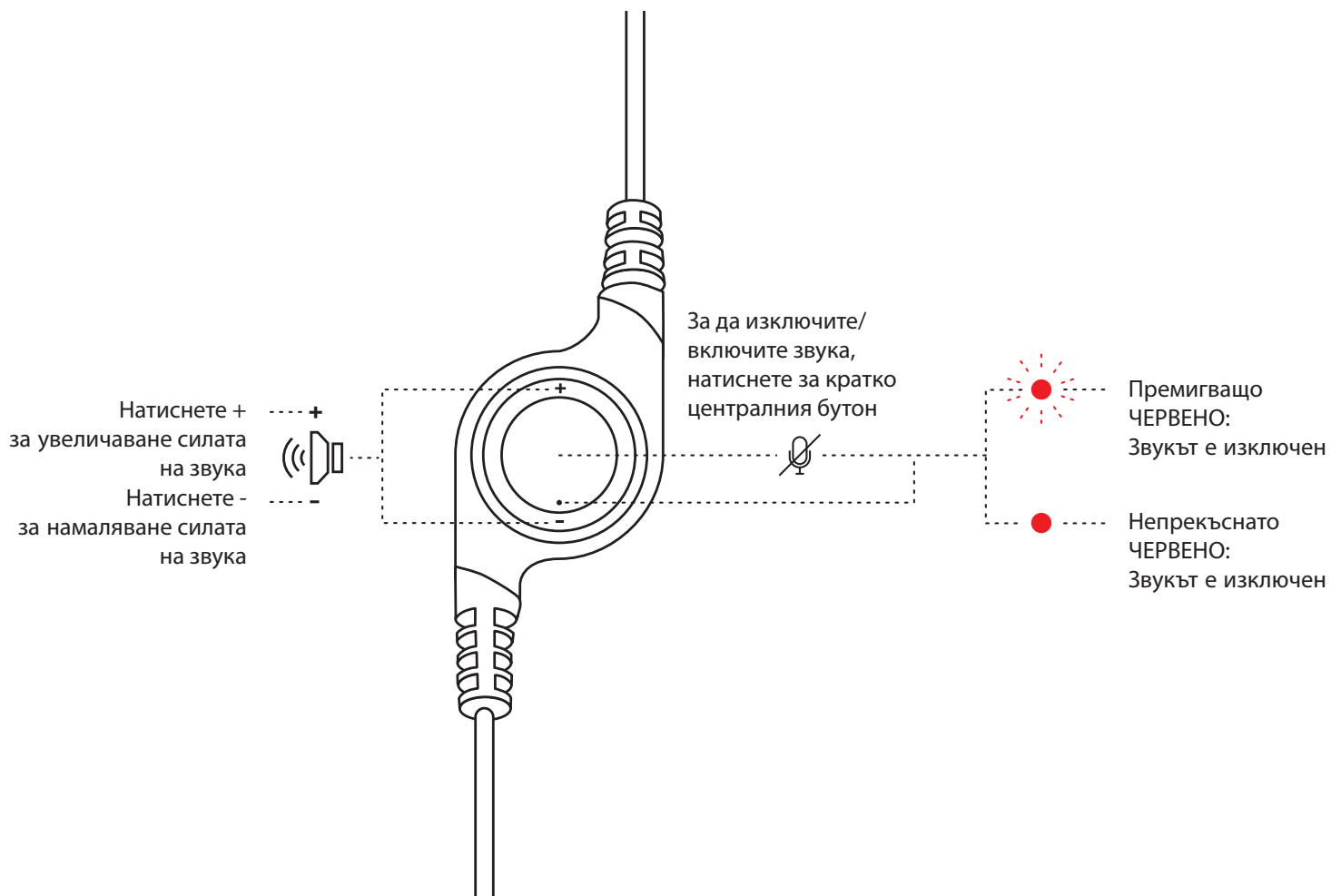

[www.logitech.com/support/H390](http://www.logitech.com/support/H390)



## UPOZNAJTE SVOJ UREĐAJ



## KONTROLER U KABELU

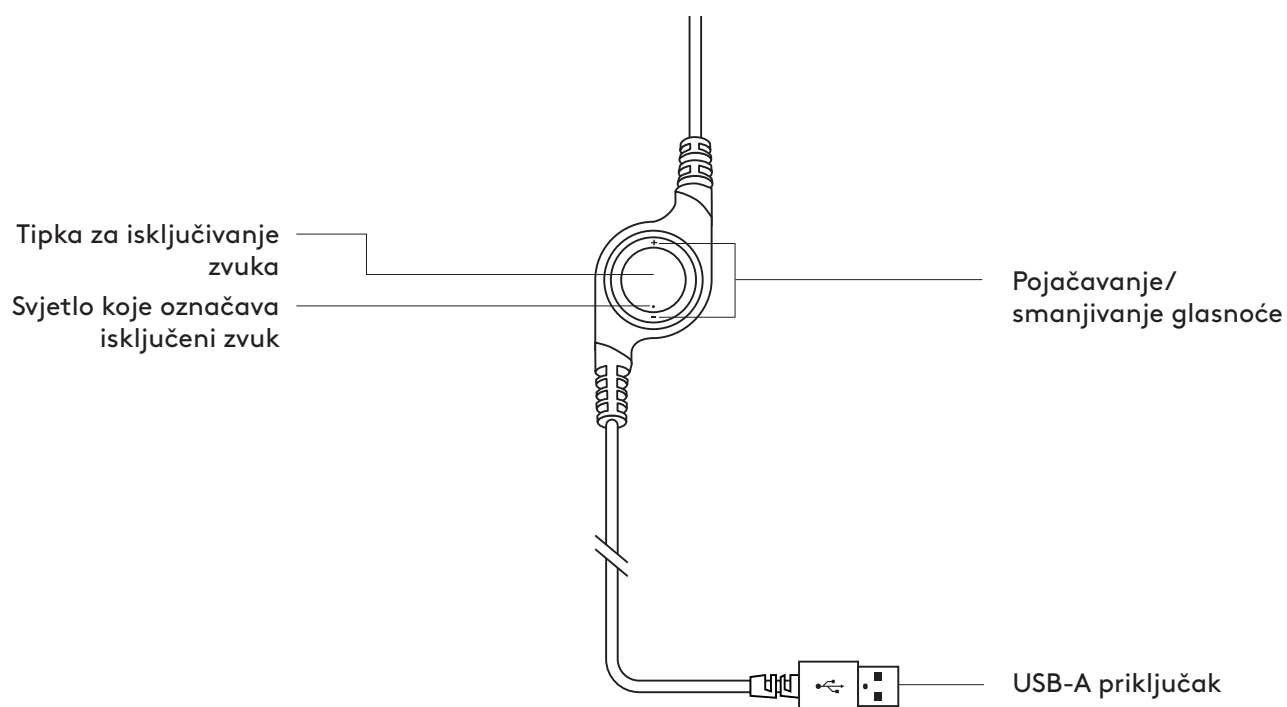

## PRIKLJUČIVANJE SLUŠALICA

Ukopčajte USB-A priključak u USB priključnicu na računalu.

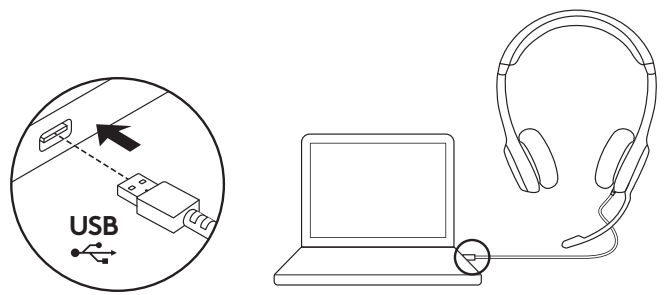

## NAMJEŠTANJE SLUŠALICA

1. Ako želite prilagoditi veličinu slušalica, pomičite traku za glavu gore i dolje da vam udobno prisjedaju.
2. Pomaknite ovjes mikrofona gore ili dolje kako bi bio u ravnini s vašim ustima za bolje hvatanje glasa.
3. Nosač se može odmaknuti da vam ne smeta kada ga ne upotrebljavate.

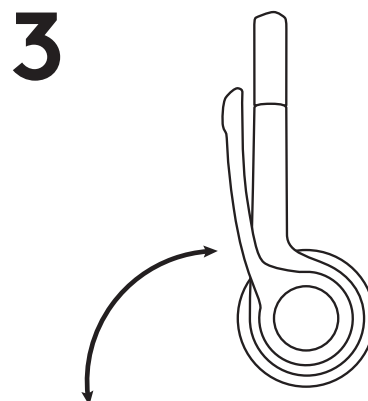
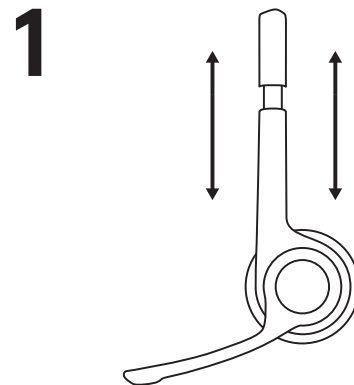

## UPRAVLJANJE

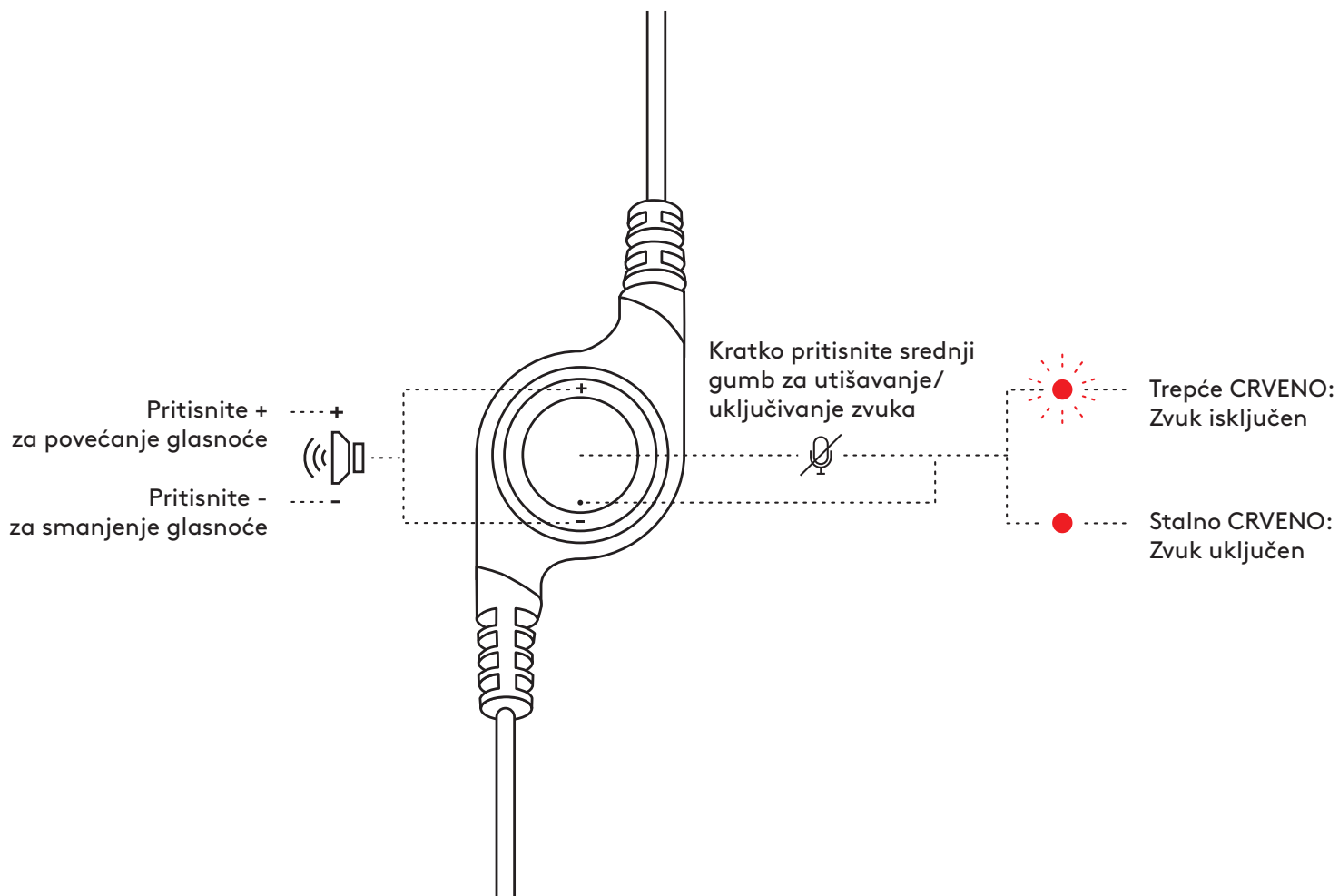

[www.logitech.com/support/H390](http://www.logitech.com/support/H390)

## UPOZNAJTE SVOJ PROIZVOD



## UGRAĐENI KONTROLER

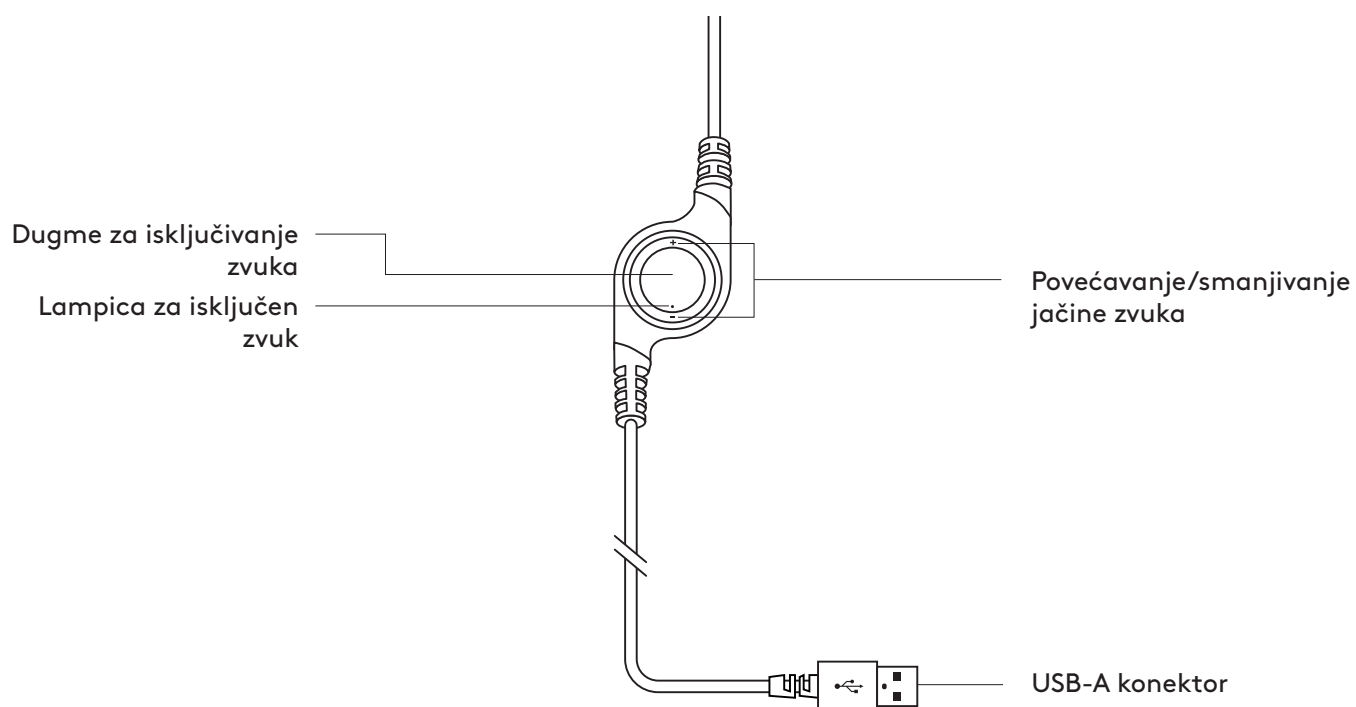

## POVEZIVANJE SLUŠALICA

Priključite USB-A konektor u USB port na računaru.

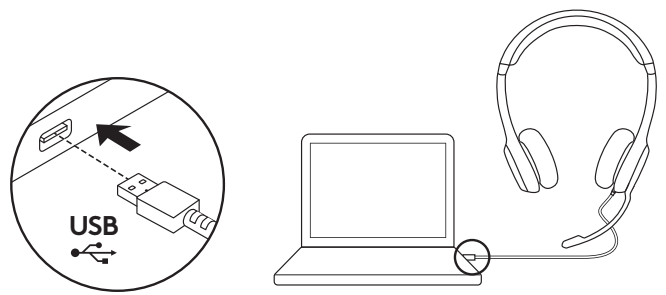

## PRILAGOĐAVANJE SLUŠALICA

1. Da biste podesili veličinu slušalica, pomerajte traku za glavu gore-dole dok je ne namestite udobno.
2. Pomerajte krak mikrofona gore-dole dok ne bude u nivou vaših usta, za bolje snimanje zvuka.
3. Držač možete da sklonite ako ga ne koristite.

1

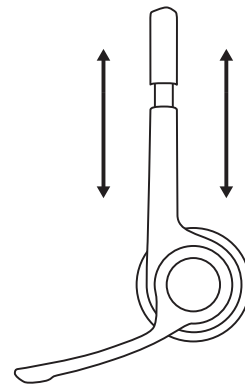

2

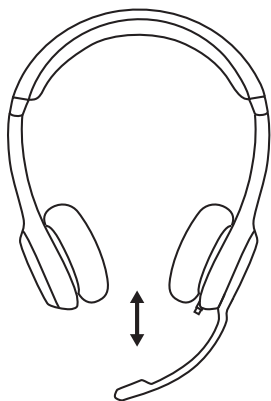

3

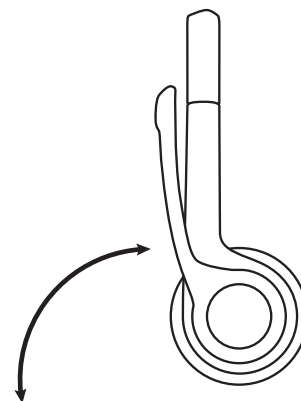

## KONTROLE

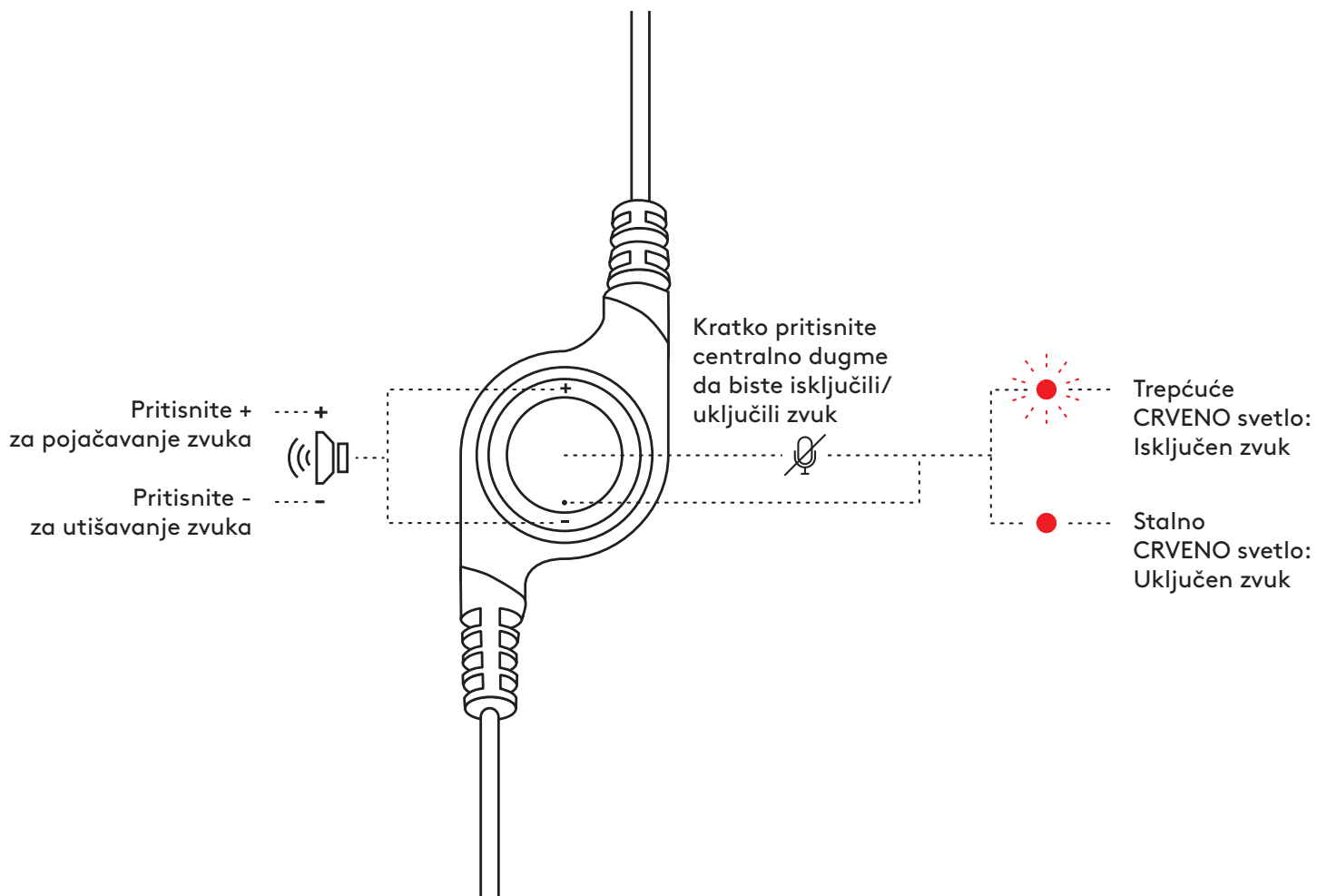

[www.logitech.com/support/H390](http://www.logitech.com/support/H390)

## SPOZNAJTE IZDELEK

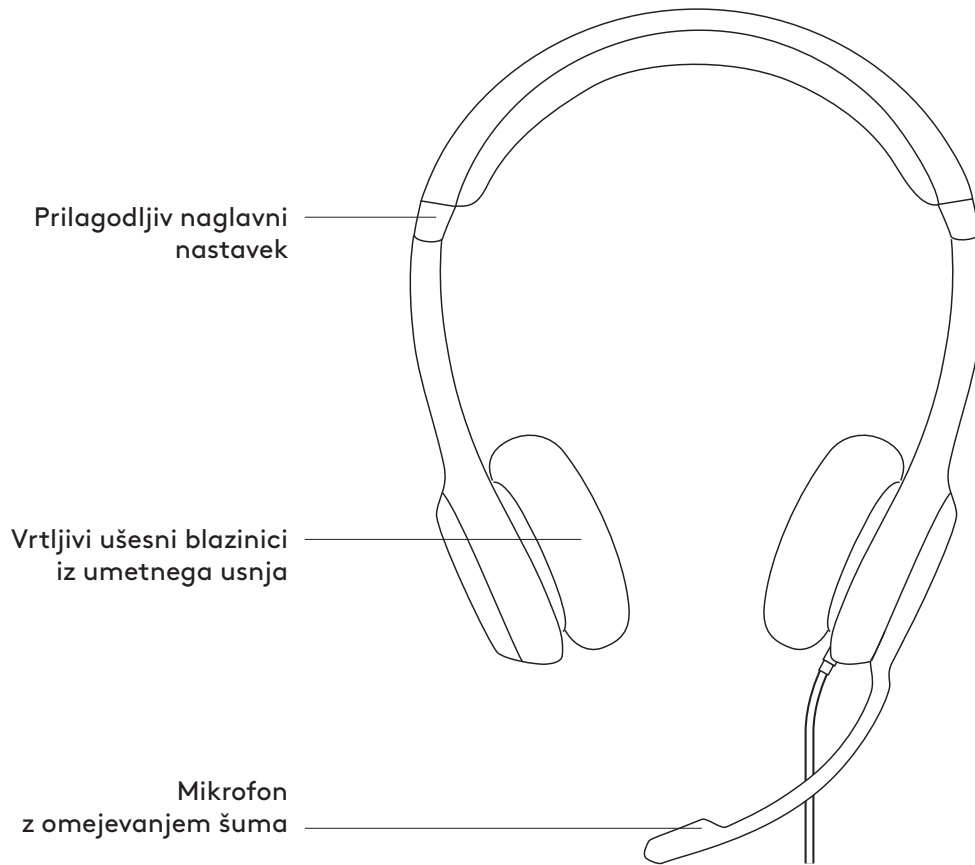

## KRMILNIK, VGRAJEN NA KABEL

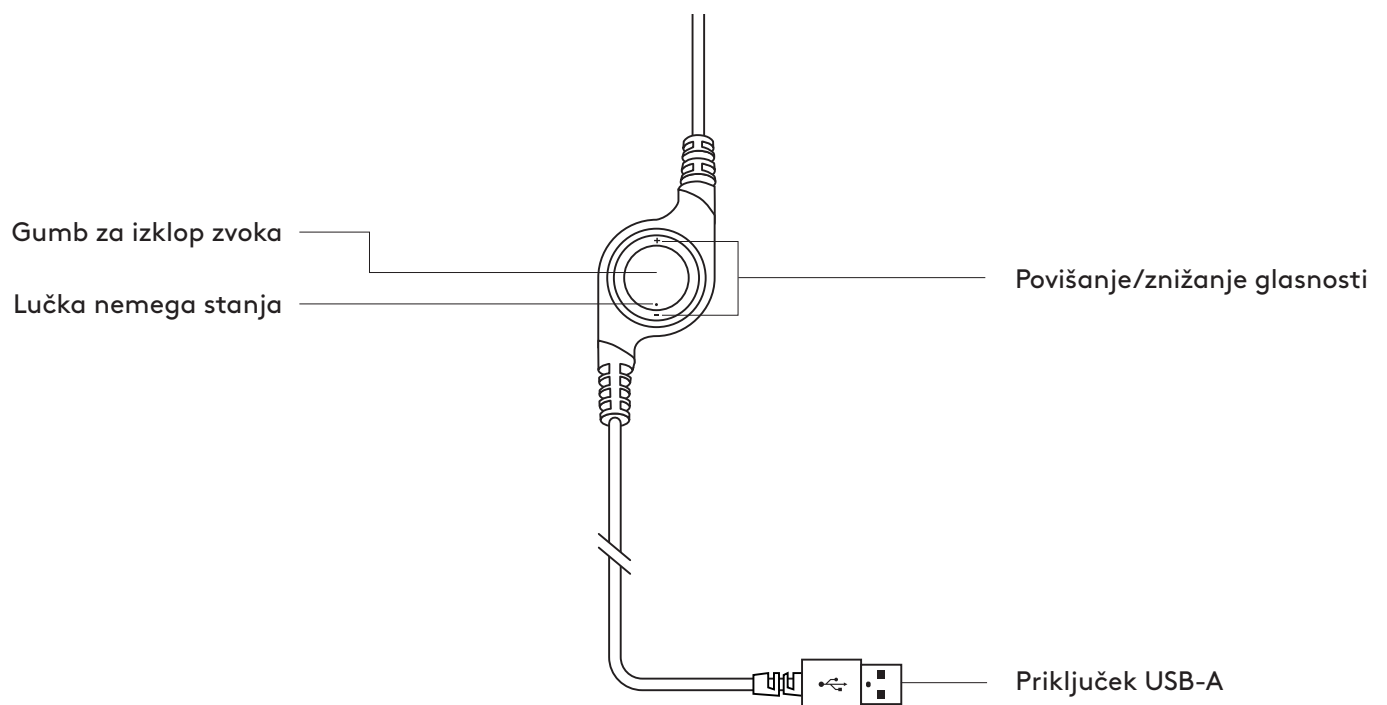

## PRIKLJUČITEV SLUŠALK

Priključek USB-A priključite v vrata USB na računalniku.

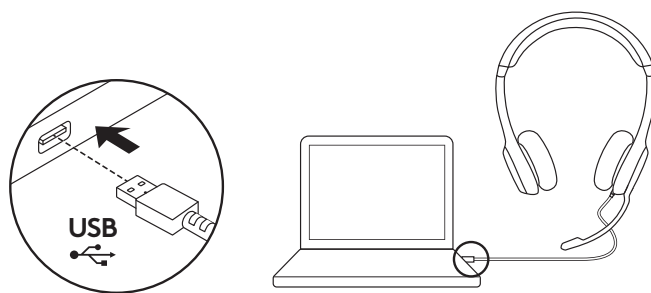

## NASTAVITEV SLUŠALK

1. Da prilagodite velikost slušalk, naglavni nastavek pomikajte navzgor ali navzdol, dokler se udobno ne prilega.
2. Da zagotovite boljši zajem glasu, mikrofona pomaknite navzgor ali navzdol, tako da je v višini ust.
3. Ko mikrofona ne uporabljate, lahko držalo zložite, da vam ne bo v napoto.

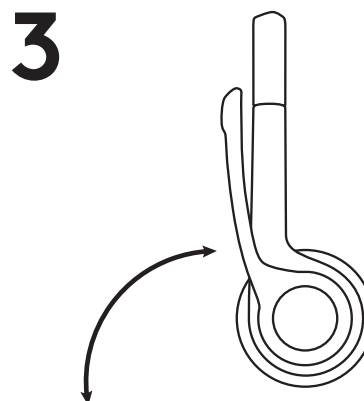
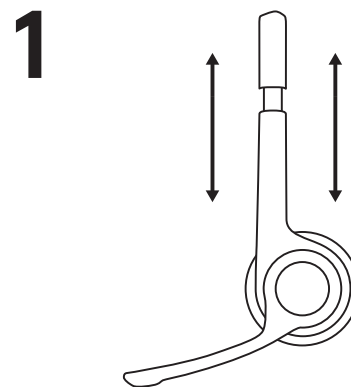



## KONTROLNIKI

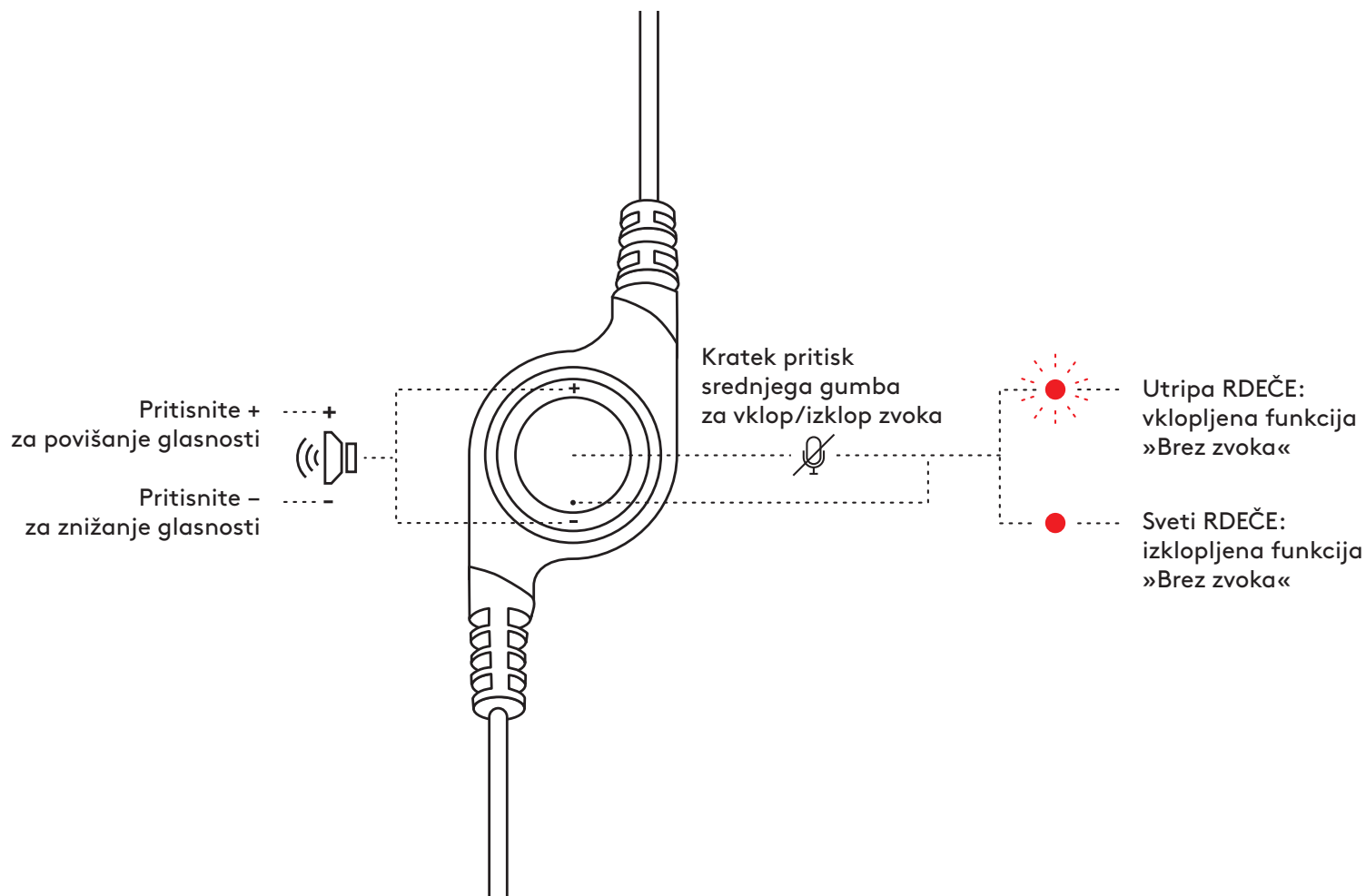

[www.logitech.com/support/H390](http://www.logitech.com/support/H390)

## FAMILIARIZAȚI-VĂ CU PRODUSUL

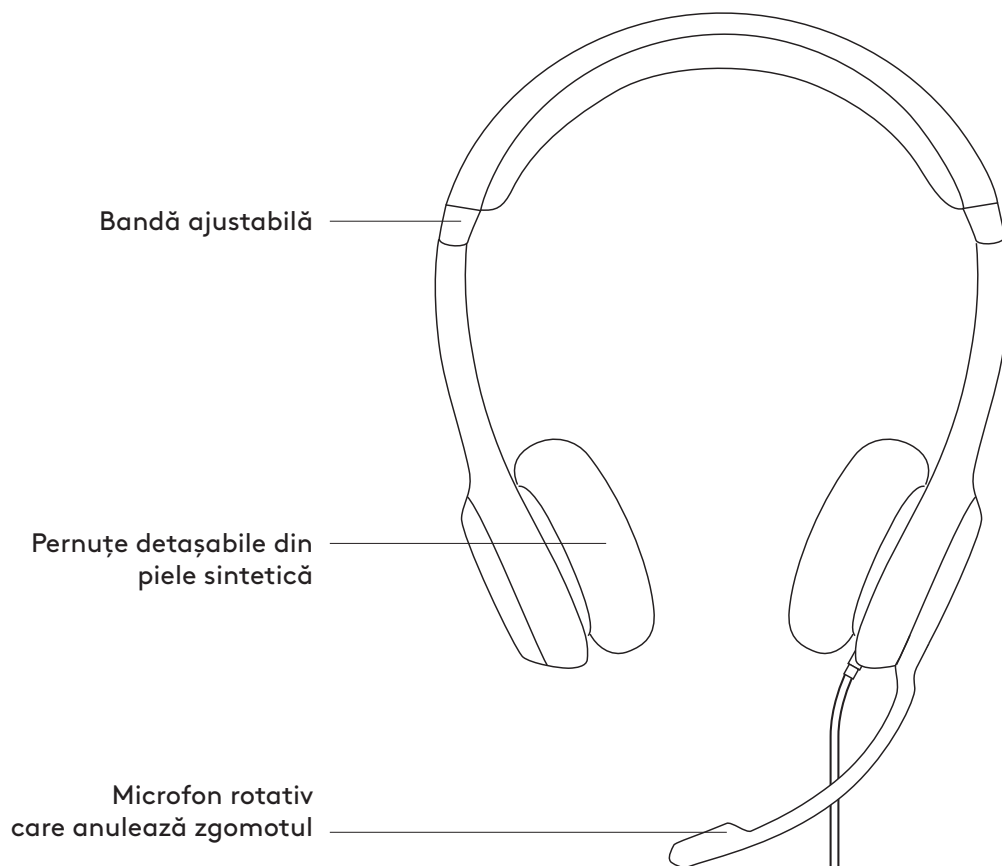

## CONTROLER PE FIR

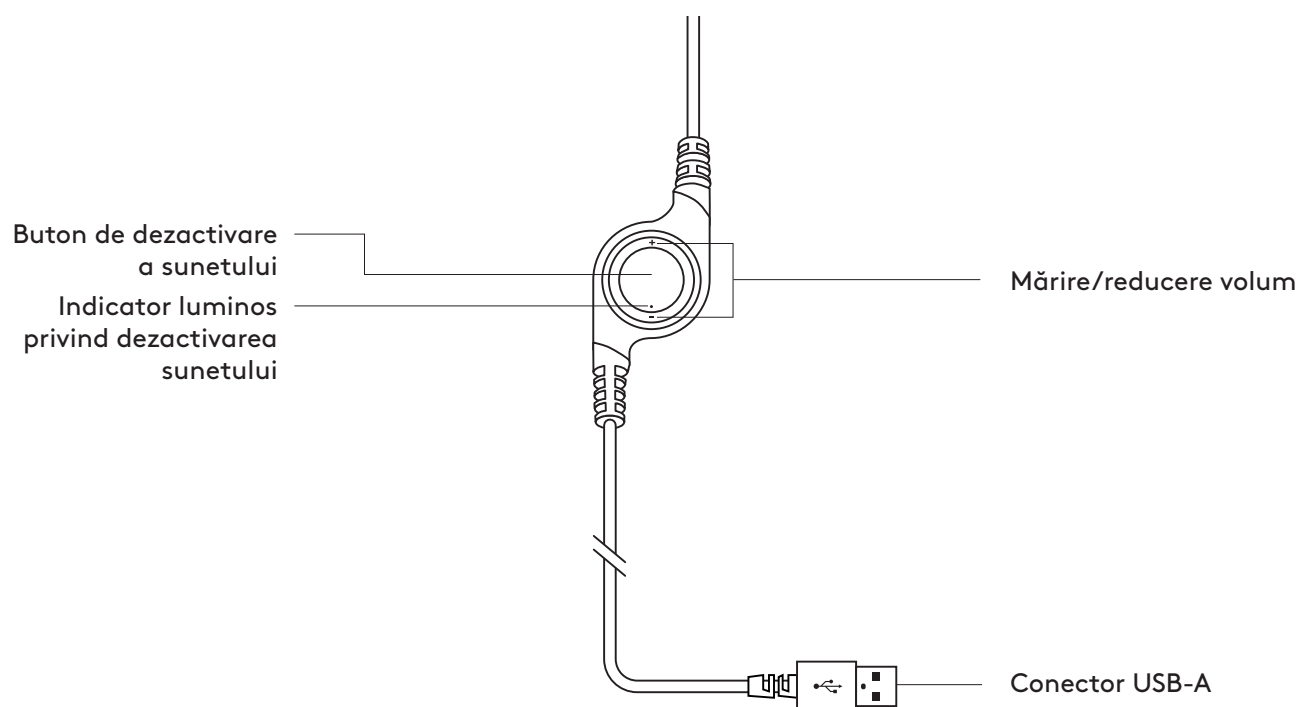

## CONECTAREA CĂȘTILOR

Conectați conectorul USB-A la un port USB al computerului.

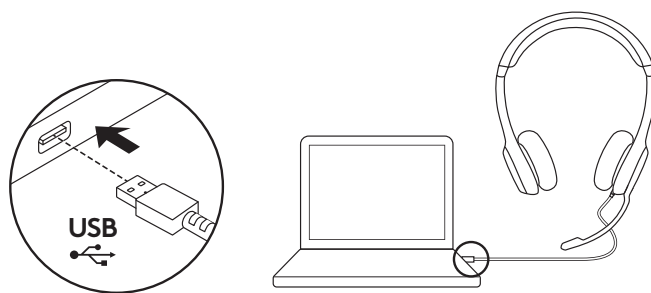

## AJUSTAREA CĂȘTILOR

1. Pentru a ajusta dimensiunea căștilor, deplasați-le în sus și în jos până când se poziționează confortabil.
2. Mutați brațul microfonului în sus sau în jos până când ajunge în dreptul gurii, pentru a capta mai bine vocea.
3. Brațul microfonului poate fi îndepărtat când nu îl folosiți.

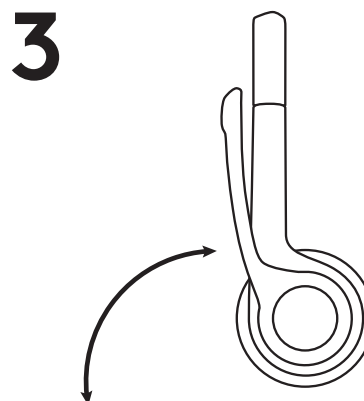
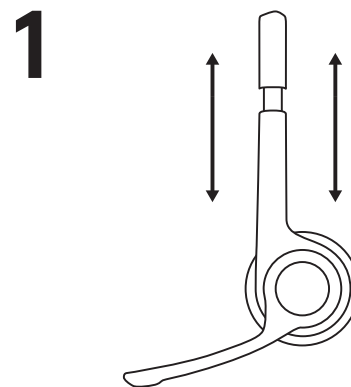

## COMENZI

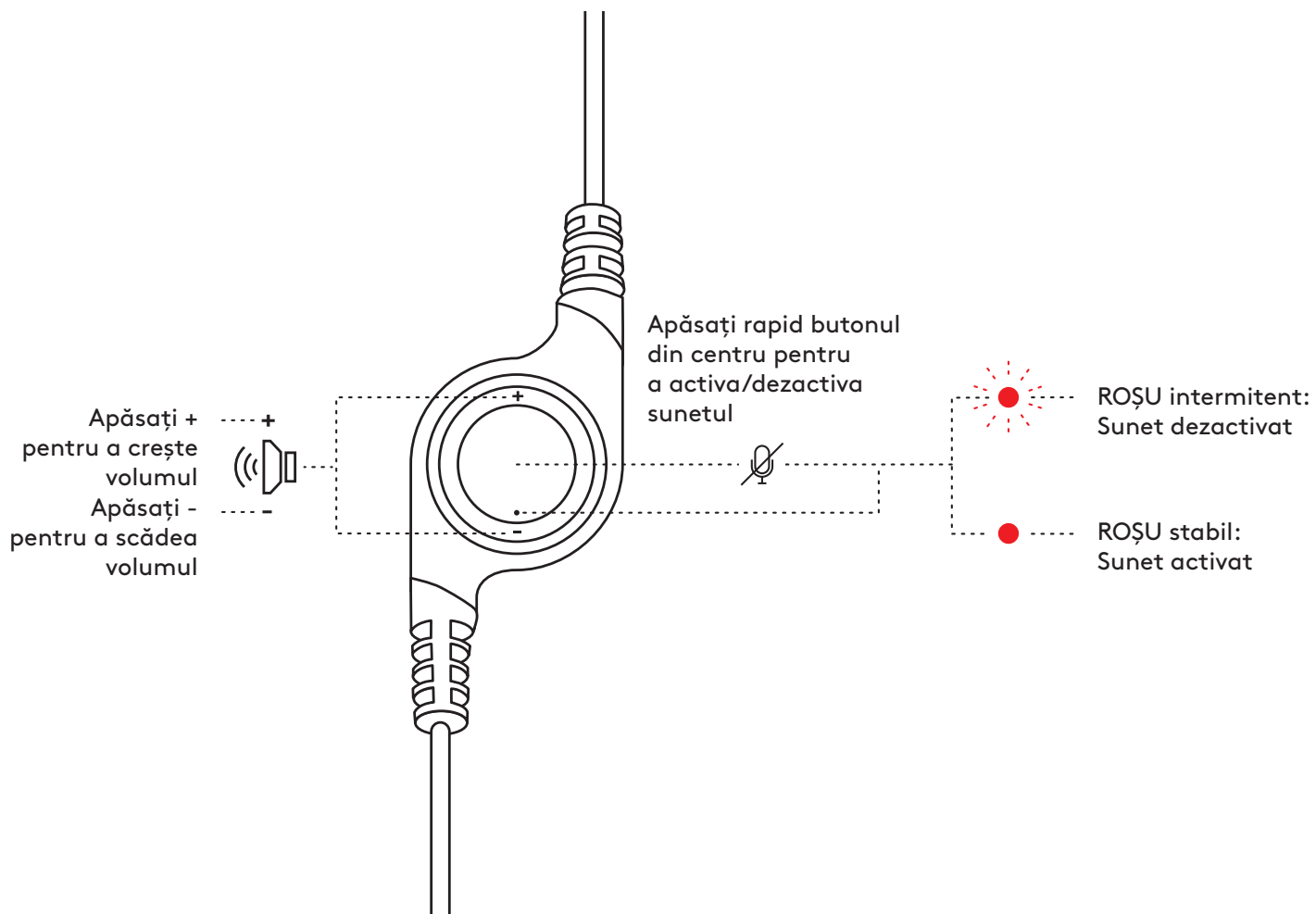

[www.logitech.com/support/H390](http://www.logitech.com/support/H390)

## ÜRÜNÜNÜZÜ TANIYIN

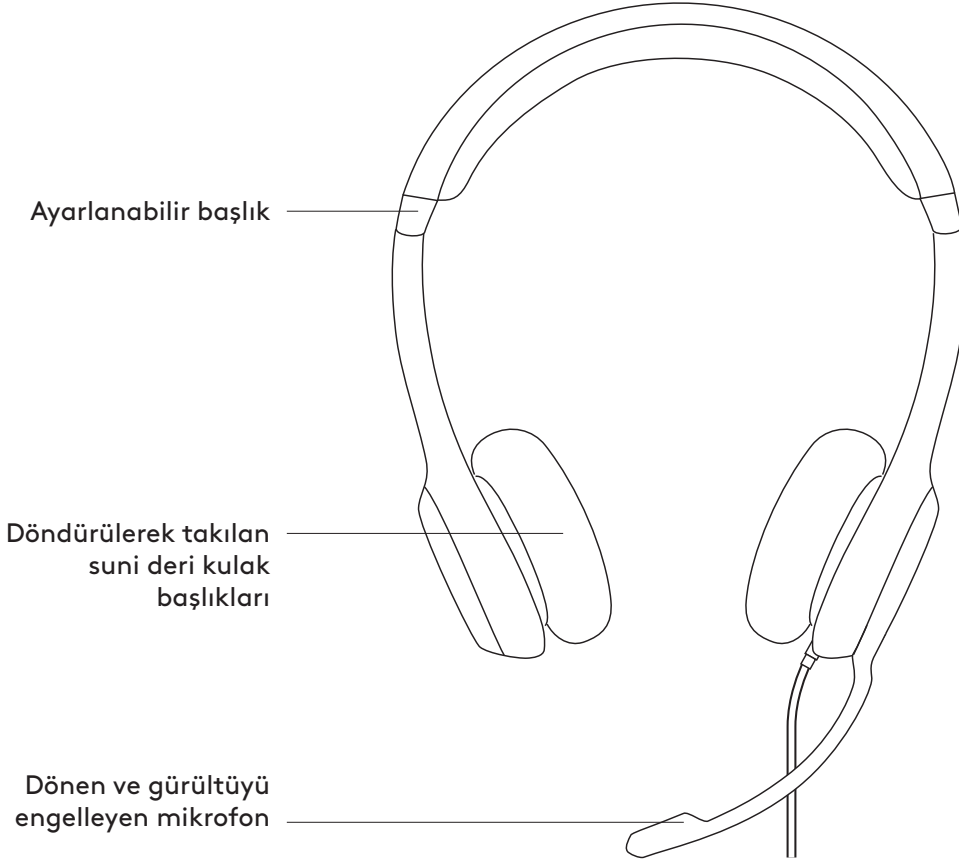

## KABLO ÜZERİ DENETLEYİCİ

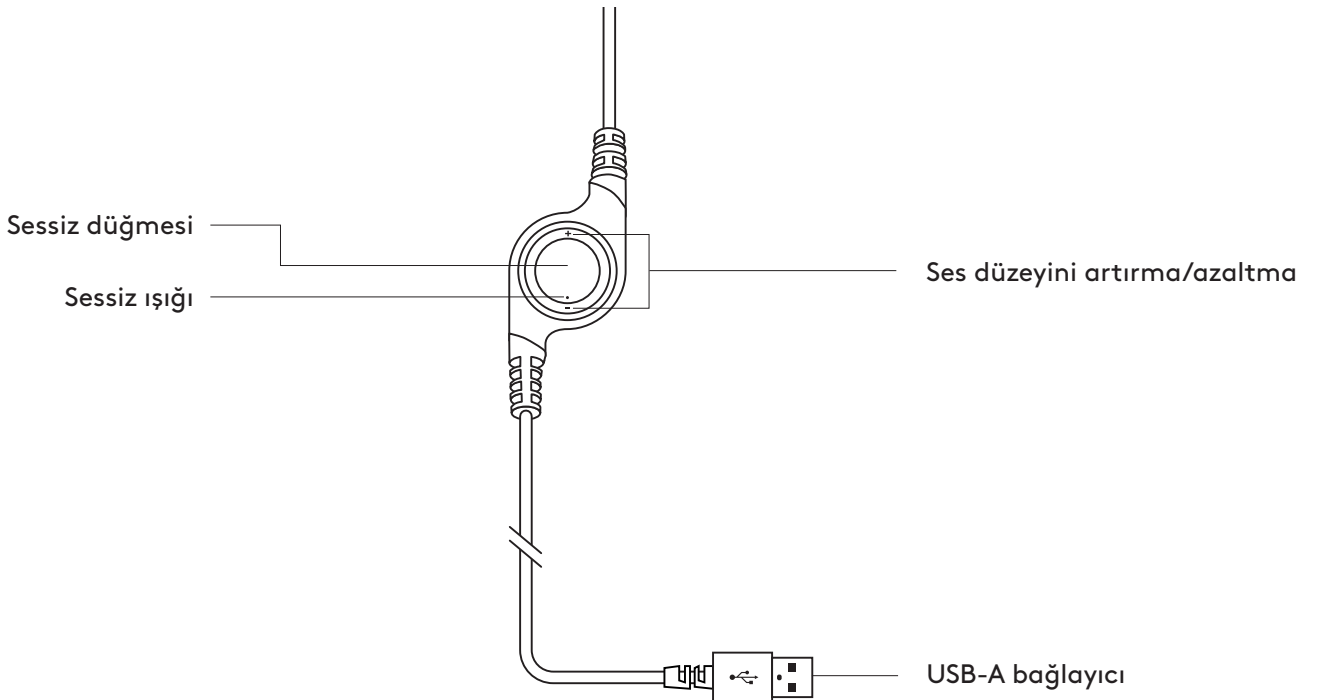

## KULAKLIĐI BAĐLAMA

USB-A bađlayıcıyı bilgisayarın USB bađlantı noktasına takın.

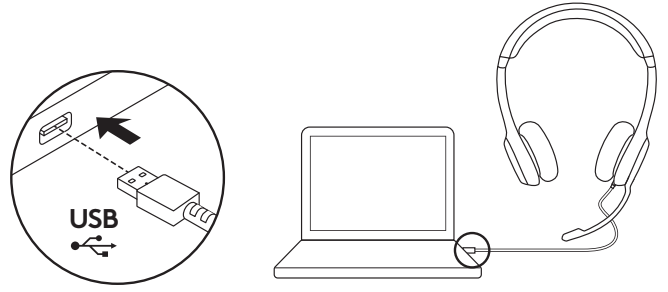

## KULAKLIĐI YERLEŐTİRME

1. Kulaklık boyutunu ayarlamak için, baŐlıđı aŐađı ve yukarı oynatıp rahat Őekilde oturacađı konumu bulun.
2. Daha iyi ses yakalayabilmesi için mikrofon kolunu aŐađı ve yukarı oynatarak ađız seviyesine getirin.
3. Mikrofon kolu, kullanmadıđınız zamanlarda önünüzü kapatmaması için gizlenebilir.

1

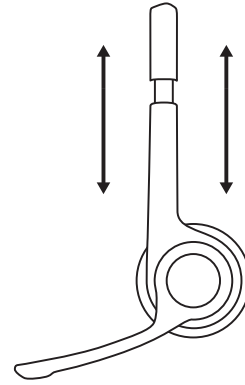

2

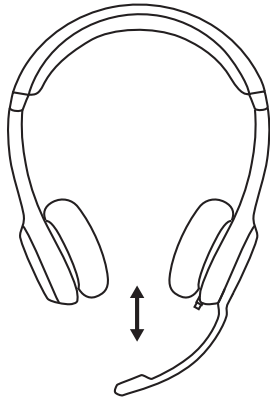

3

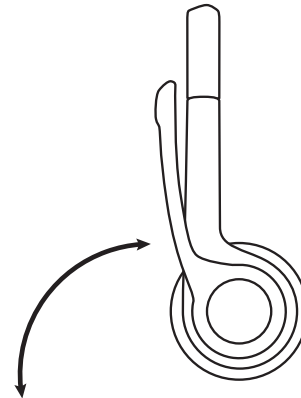

## DENETİMLER

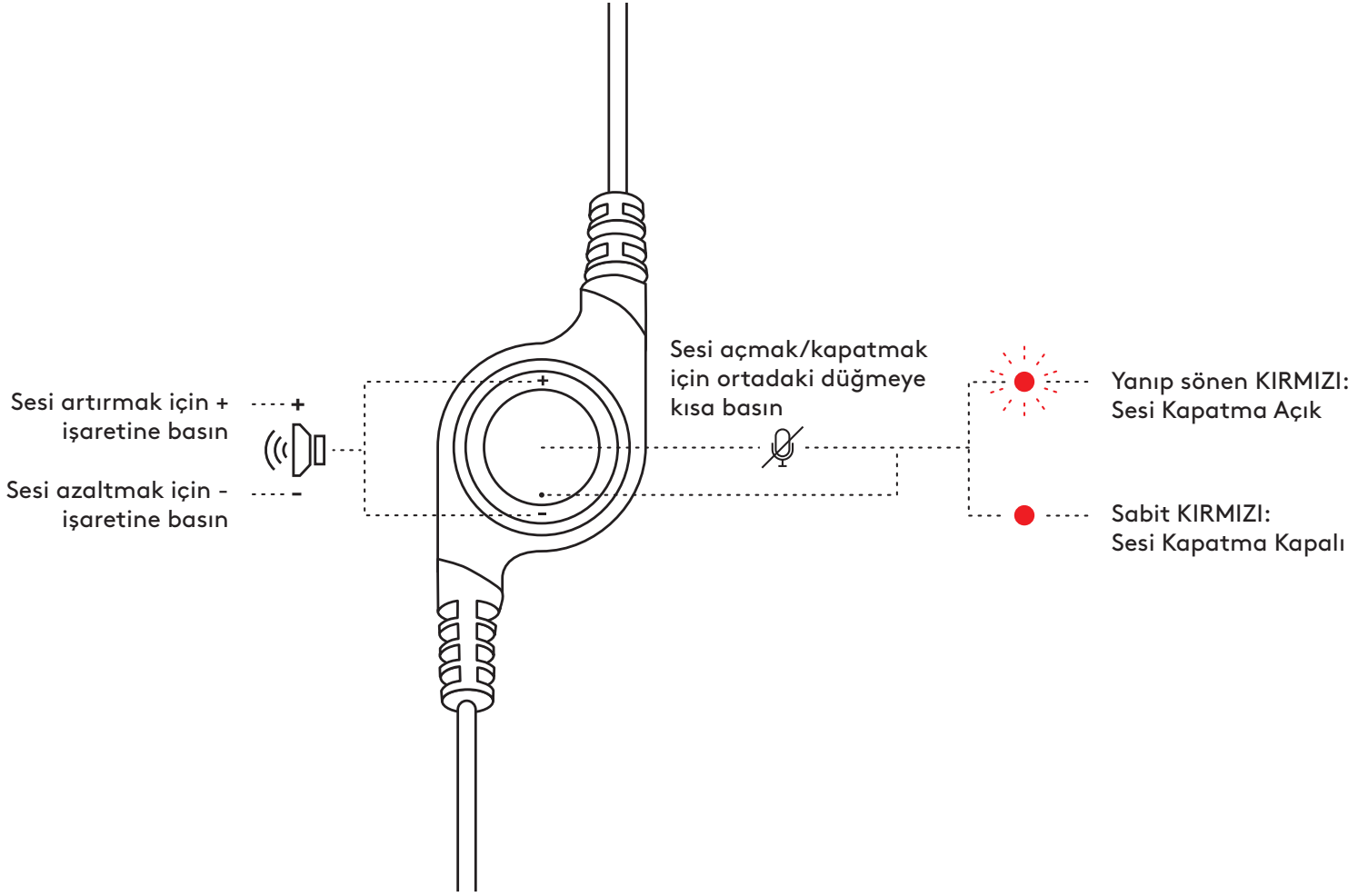

[www.logitech.com/support/H390](http://www.logitech.com/support/H390)

## تعرف على المنتج



## وحدة تحكم داخلية

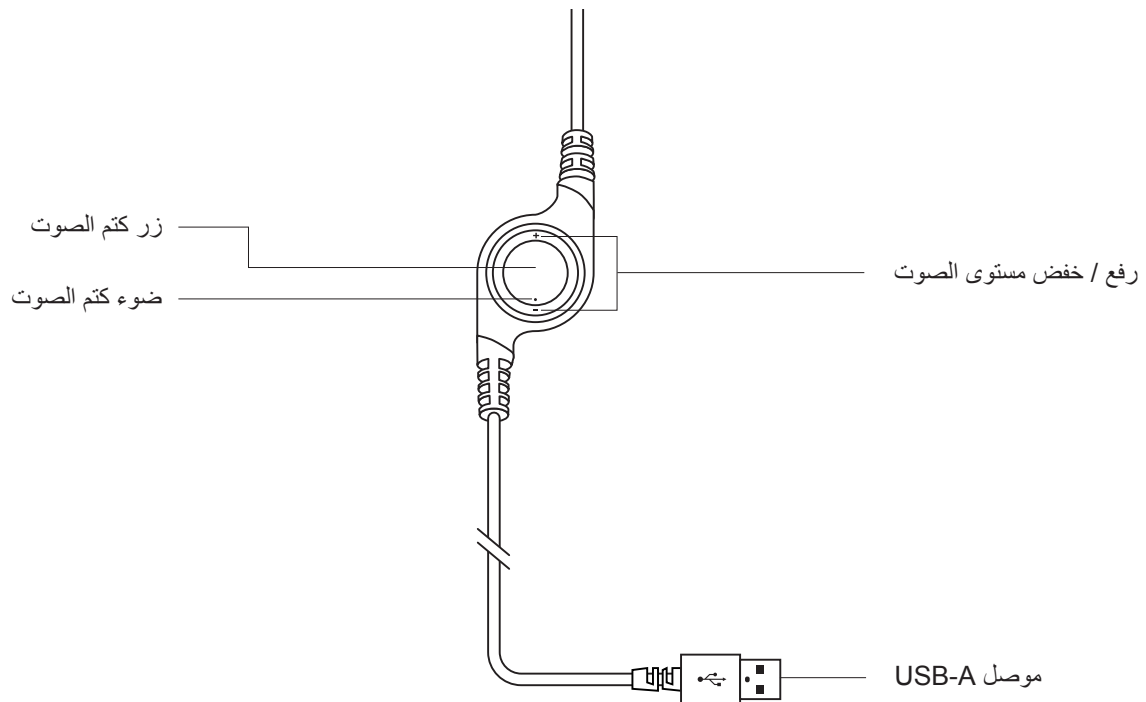



توصيل سماعة الرأس  
وصل موصل USB-A بمنفذ USB بالكمبيوتر.

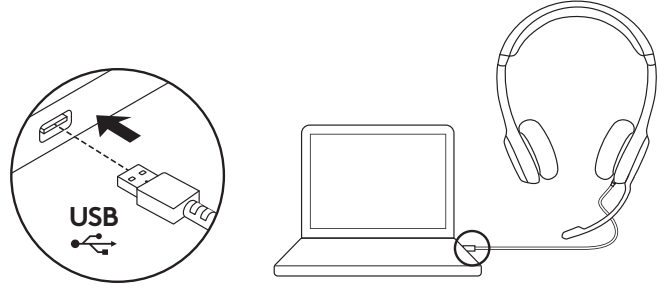

### تكييف سماعة الرأس

1. لضبط حجم سماعة الرأس، حرّك عصابة الرأس لأعلى ولأسفل حتى تصبح مريحة.
2. حرّك رأس الميكروفون لأعلى أو لأسفل وللداخل أو للخارج حتى يكون مستويًا عند الفم لالتقاط الصوت بشكل أفضل.
3. يمكن طي الذراع عند عدم استخدامه.

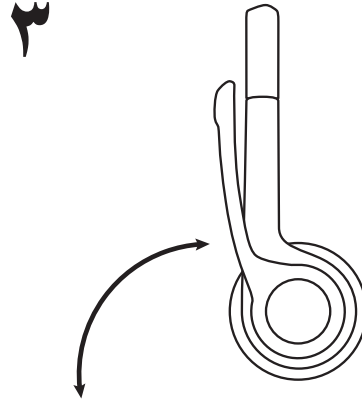
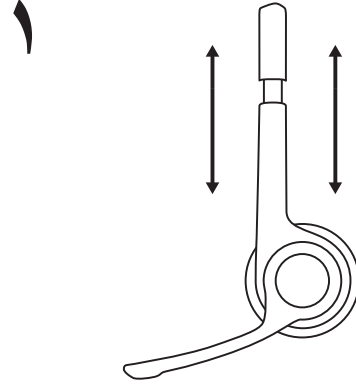

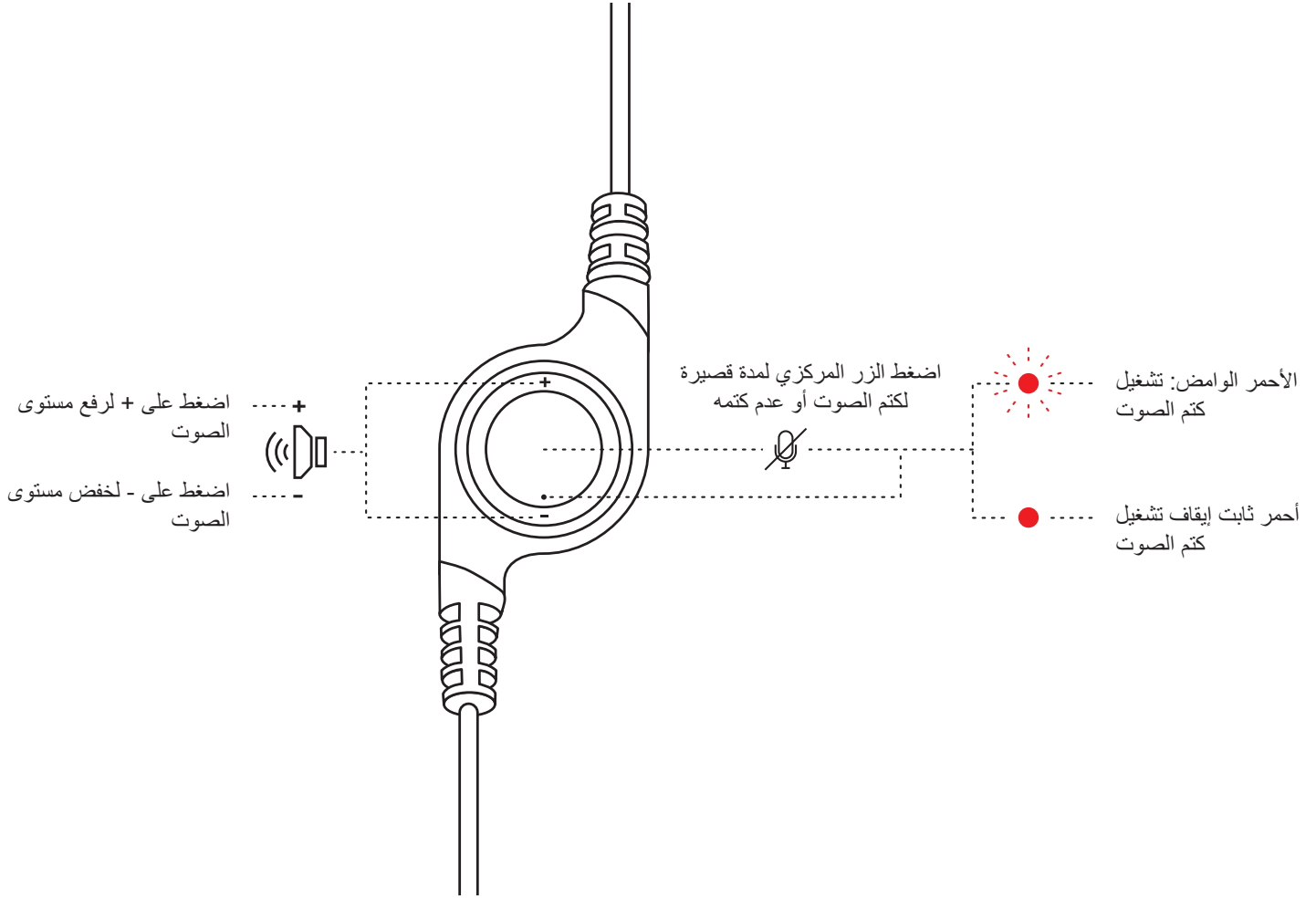

[www.logitech.com/support/H390](http://www.logitech.com/support/H390)

## הכר את המוצר



## בקר פנימי

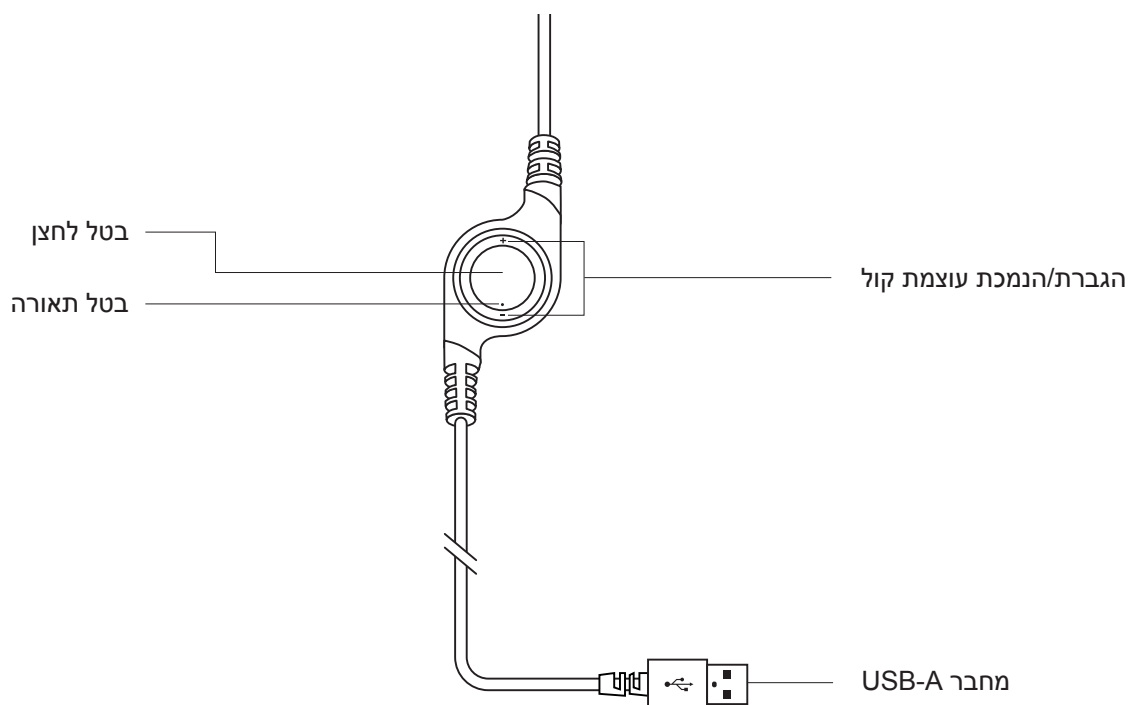

### חיבור האוזניות

חבר את מחבר ה-USB-A אל יציאת USB במחשב.

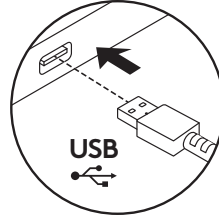

### התאמת האוזניות

1. הזז את רצועת הראש כלפי מעלה ומטה על מנת לכווון את גודל האוזניה, עד אשר תותאם בנוחות.
2. הזז את הבום של המיקרופון כלפי מעלה ומטה עד אשר הוא מאוזן אל מול הפה ללכידת שמע טובה יותר.
3. כאשר לא נעשה שימוש בבום ניתן לקפל אותו.

1

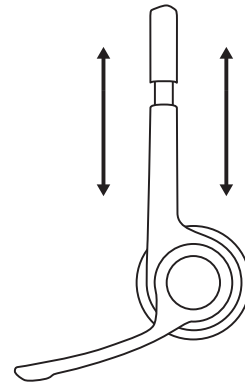

2

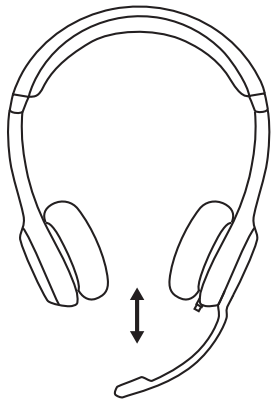

3

