

BRIO 90

Setup Guide
设置指南

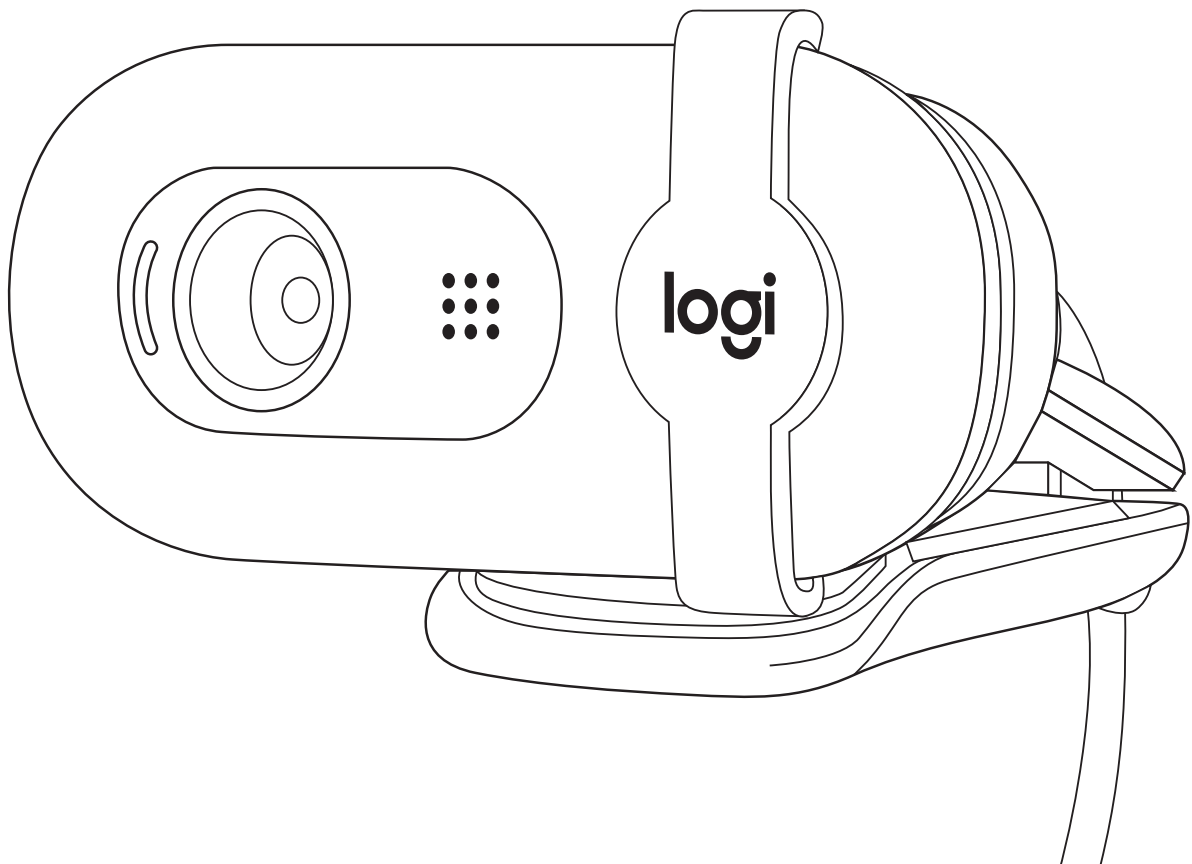

CONTENTS

English 3

简体中文 6

KNOW YOUR PRODUCT

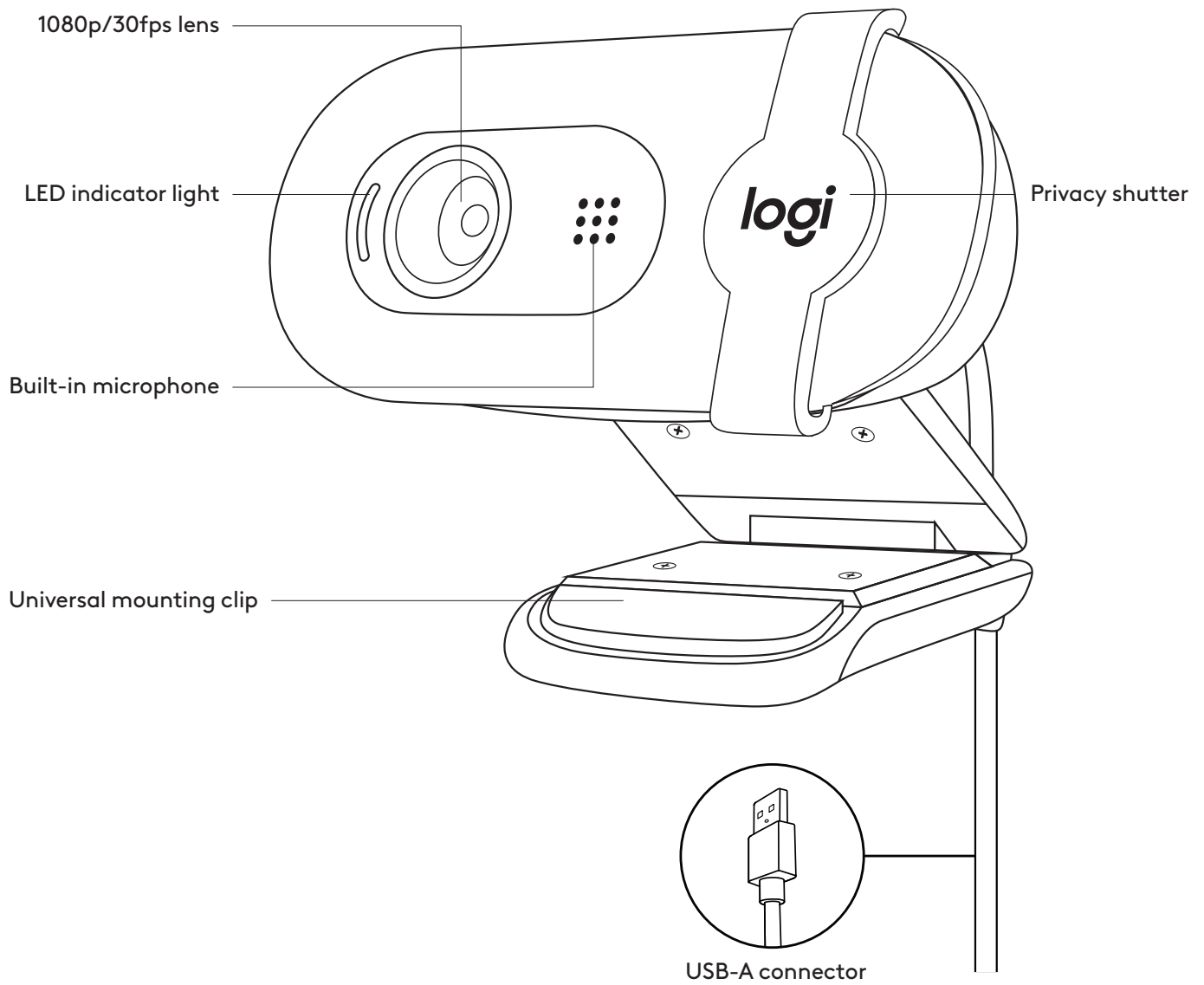

WHAT'S IN THE BOX

- 1 Webcam with 7 ft (2 m) attached USB-A cable
- 2 User documentation

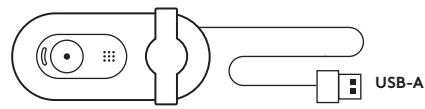

SETTING UP THE WEBCAM

For placement on a monitor

- 1 Place your webcam on a computer, laptop or monitor at a position or angle you desire.

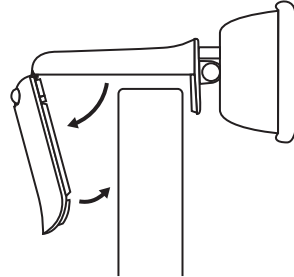

- 2 Adjust the webcam to make sure the end of the universal mounting clip is flush with the back of your device.

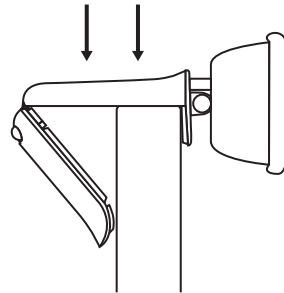

- 3 Manually tilt the webcam up or down to frame yourself within the camera's view.

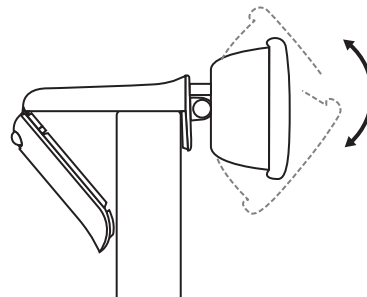

CONNECTING THE WEBCAM VIA USB-A

Plug the USB-A connector into the corresponding port on your computer.

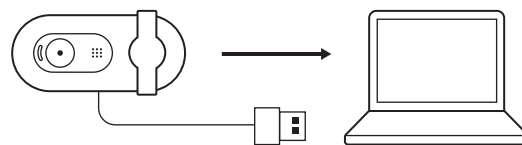

SUCCESSFUL CONNECTION

LED light indicates when the webcam is on and being used by an application.

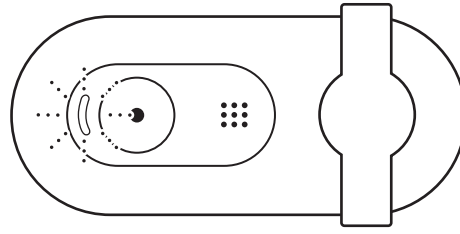

Open the privacy shutter by gently sliding it from left all the way to right. Be sure it does not cover the built-in microphone.

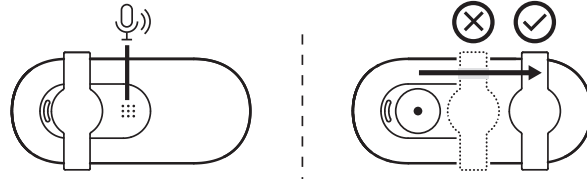

DIMENSIONS

WEBCAM:

Height x Width x Depth:

1.26 in (31.91 mm) x 2.87 in (72.91 mm) x 2.62 in (66.64 mm)

Weight: 2.65 oz (75 g)

www.logitech.com/support/Brio90

了解您的产品

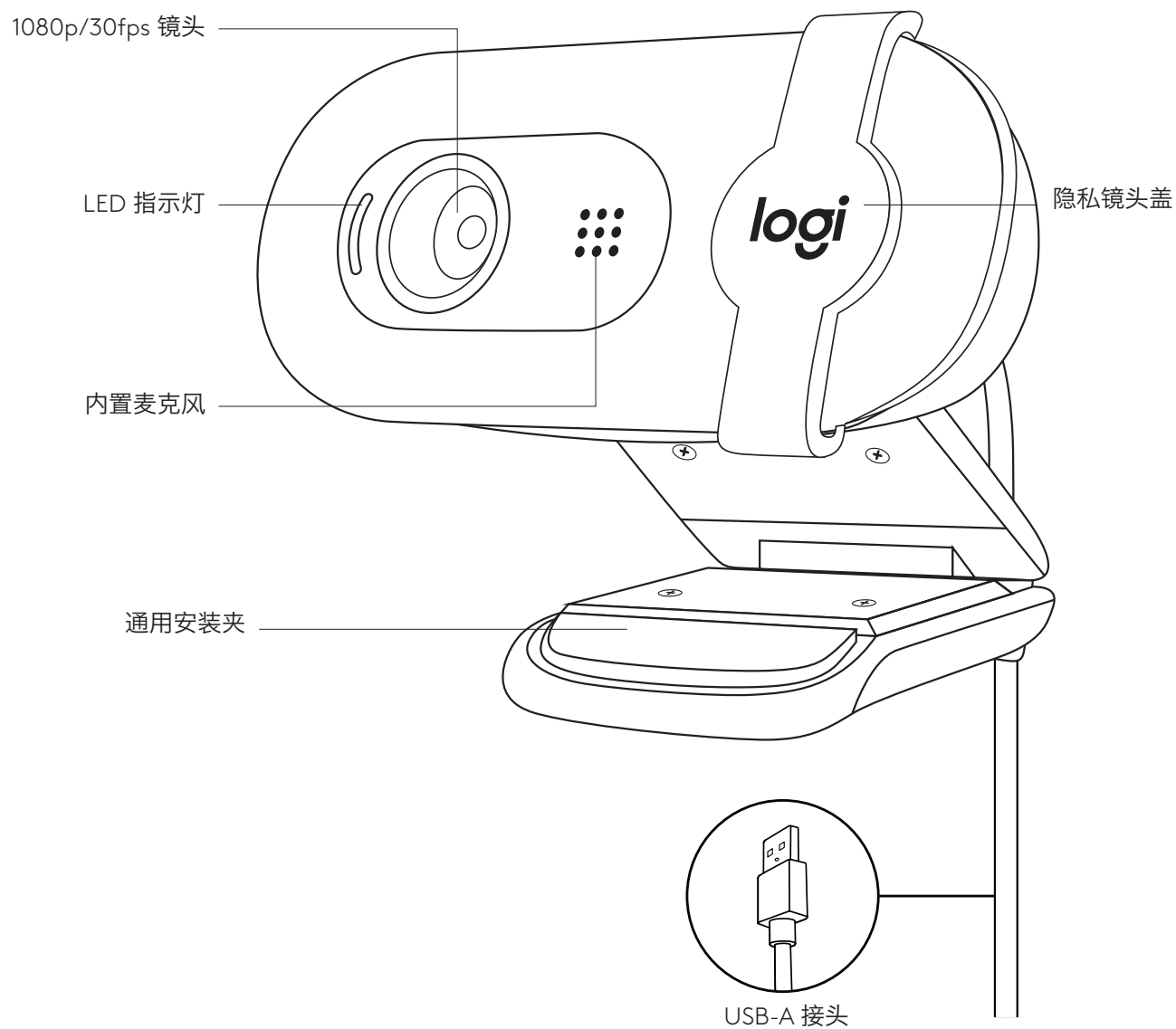

包装内容

- 1 网络摄像头，附 2 米 USB-A 线缆
- 2 用户文档

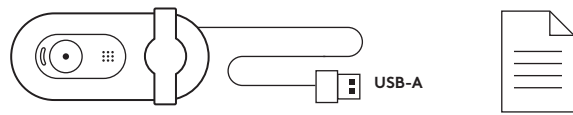

设置网络摄像头

放置于显示器上

- 1 将网络摄像头以所需的位置或角度放置在电脑、笔记本电脑或显示器上。

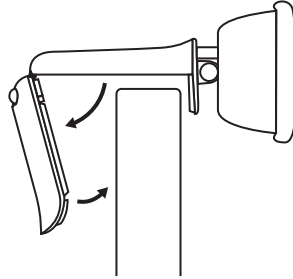

- 2 调节网络摄像头，确保通用安装夹底端与显示器背面齐平。

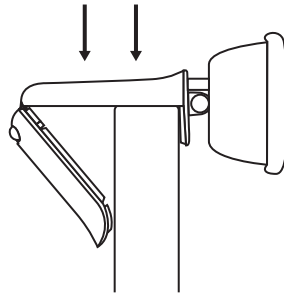

- 3 手动向上或向下倾斜网络摄像头，使自己处于摄像头视野内。

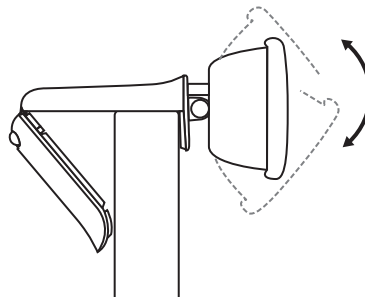

通过 USB-A 连接网络摄像头

将 USB-A 接头插入电脑的相应端口。

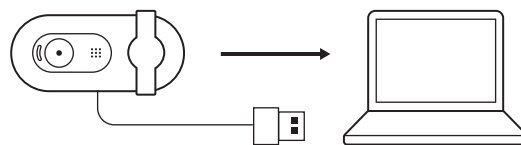

成功连接

LED 指示灯可指示网络摄像头的开机状态和正被应用程序使用状态。

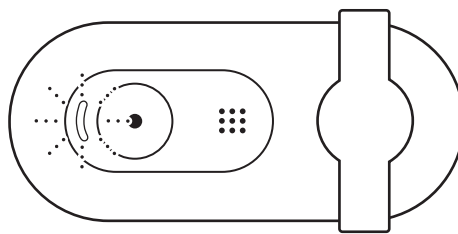

从左向右轻滑隐私镜头盖，将其打开。确保其未盖住内置麦克风。

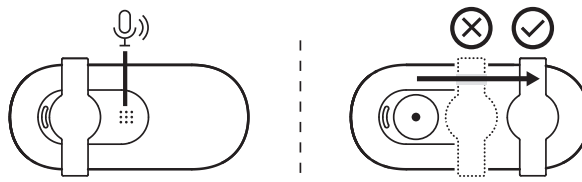

规格

网络摄像头:

高 x 宽 x 深:

31.91 毫米 x 72.91 毫米 x 66.64 毫米

重量: 75 克

www.logitech.com/support/Brio90