

# PRO X SE

SETUP GUIDE | GUIDE D'INSTALLATION

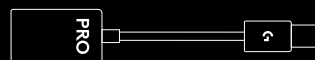

logitech 

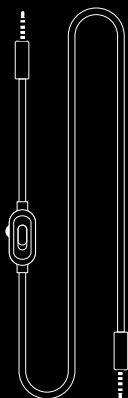

ENGLISH . . . . .	3
FRANÇAIS. . . . .	6
ESPAÑOL . . . . .	9
PORTUGUÊS . . . . .	12

## PC SETUP

- 1 Plug in microphone
- 2 Plug console/PC cable into headset
- 3 Using USB DAC:
  1. Plug console/PC cable into USB DAC
  2. Plug USB DAC into PC<sup>1</sup>

- 4 Using PC sound card:
  1. Plug console/PC cable into PC splitter
  2. Plug PC splitter into PC's headphone and mic ports

<sup>1</sup>Included USB DAC enables 5-band EQ tuning, DTS Headphone:X 2.0 and Blue VO!CE microphone filters on PC. Requires Logitech G HUB software download. 5-band EQ tuning, DTS Headphone:X 2.0 and Blue VO!CE are not available while using PC sound card.

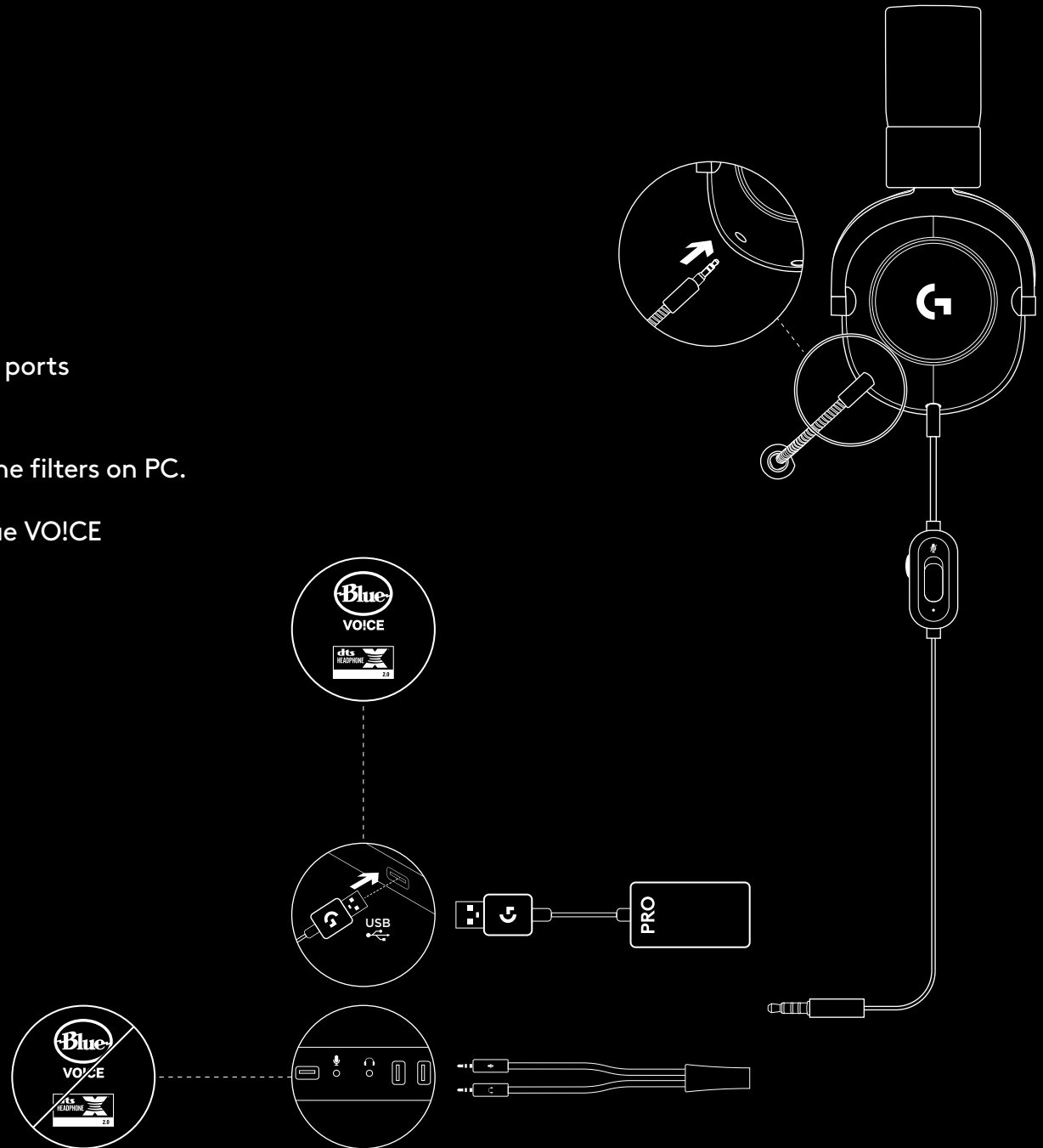

## CONSOLE SETUP (XBOX™, PLAYSTATION®)

- 1 Plug in microphone
- 2 Plug console/PC cable into headset
- 3 Plug other end into controller<sup>2</sup>

<sup>2</sup> Instructions may vary based on your system version. Please check your console manual for additional guidance. Xbox and PlayStation operate in stereo mode only via analog cable. Some Xbox controllers may require Xbox Stereo Headset Adapter, sold separately. 5-band EQ tuning, DTS Headphone:X 2.0 and Blue VO!CE are not available while connected to console controller.

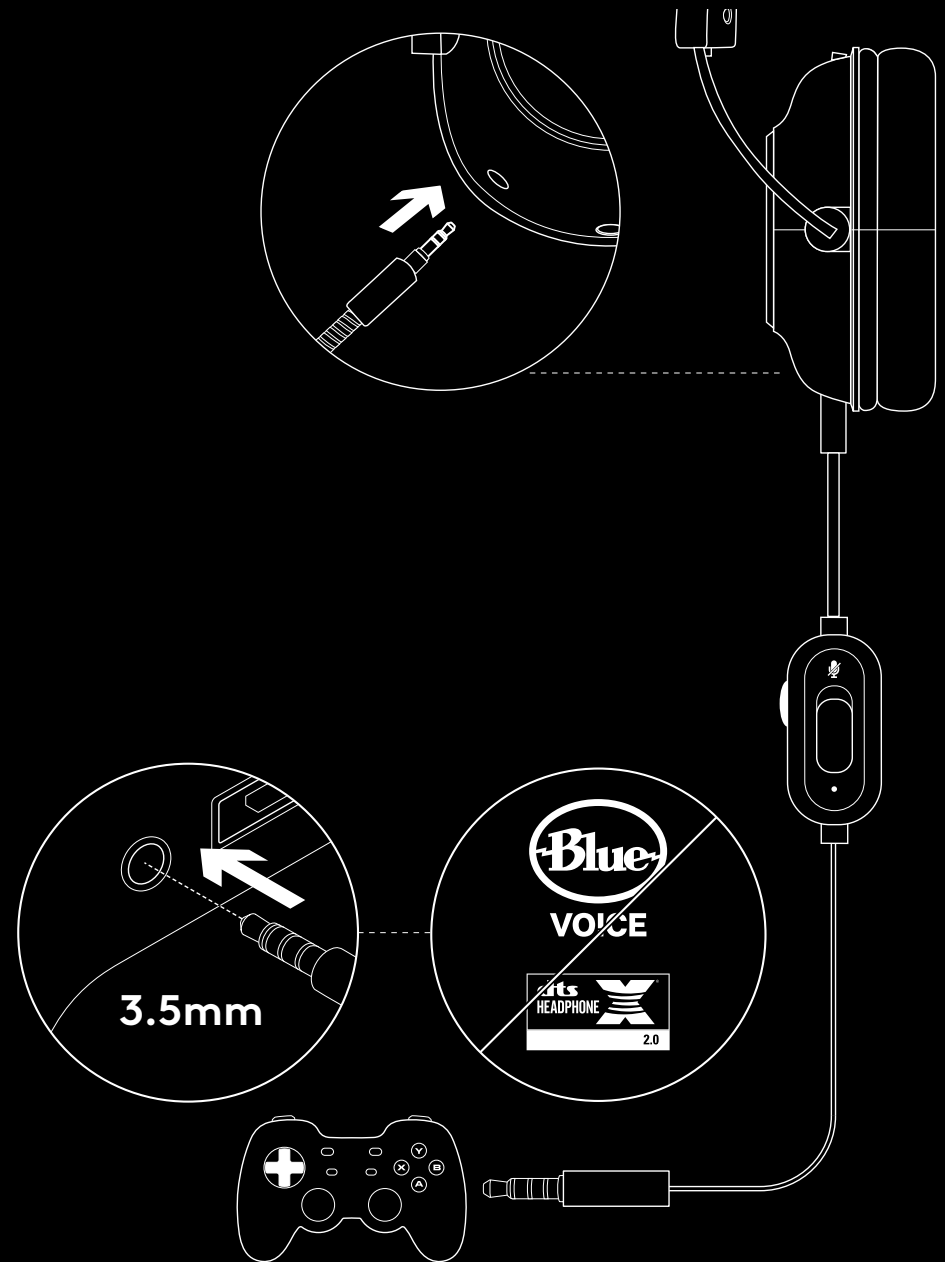

## MICROPHONE PLACEMENT

Ideal placement of the microphone is at the corner of your mouth. In this position, your voice can be heard clearly without the microphone picking up breathing sounds.

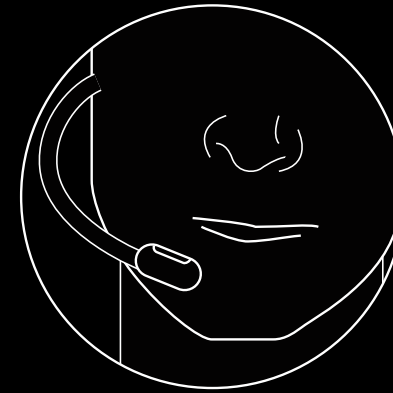

## FREQUENTLY ASKED QUESTIONS

Q: How do I save a custom EQ to the USB DAC?

A: Connect the USB DAC to a PC's USB port and use G HUB software to download a pre-configured EQ from your favorite pro gamer, or to configure your own custom EQ settings. After using G HUB to save your EQ to the DAC, you can then enjoy your custom settings even on tournament PCs with no G HUB software installed.

Q: Can I save Blue VO!CE settings to the USB DAC?

A: No, Blue VO!CE technology is only available while using G HUB software and the USB DAC on PC.

Q: Can I save DTS Headphone:X 2.0 settings to the USB DAC?

A: No, DTS Headphone:X 2.0 is only available while using G HUB software and the USB DAC on PC.

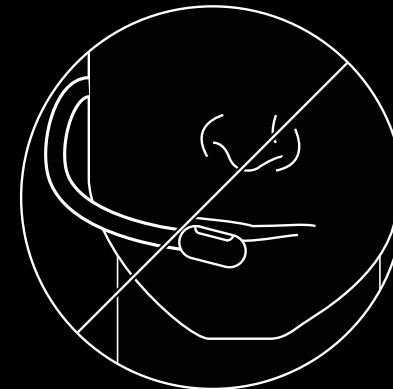

[www.logitechG.com/GHUB](http://www.logitechG.com/GHUB)

[www.logitechG.com/support/pro-x-se-headset](http://www.logitechG.com/support/pro-x-se-headset)



## CONFIGURATION CONSOLE (XBOX™, PLAYSTATION®)

- 1 Branchez le microphone
- 2 Branchez le câble de la console / du PC au casque
- 3 Branchez l'autre extrémité à la manette<sup>2</sup>

<sup>2</sup> Les instructions peuvent varier en fonction de la version de votre système.

Veuillez consulter le manuel de votre console pour plus d'informations.

Xbox et PlayStation fonctionnent uniquement en mode stéréo via un câble analogique. Certaines manettes Xbox peuvent nécessiter un adaptateur de casque stéréo Xbox vendu séparément.

Le réglage de l'égaliseur à 5 bandes, le DTS Headphone:X 2.0 et Blue VO!CE ne sont pas disponibles lors de la connexion à la manette de la console.

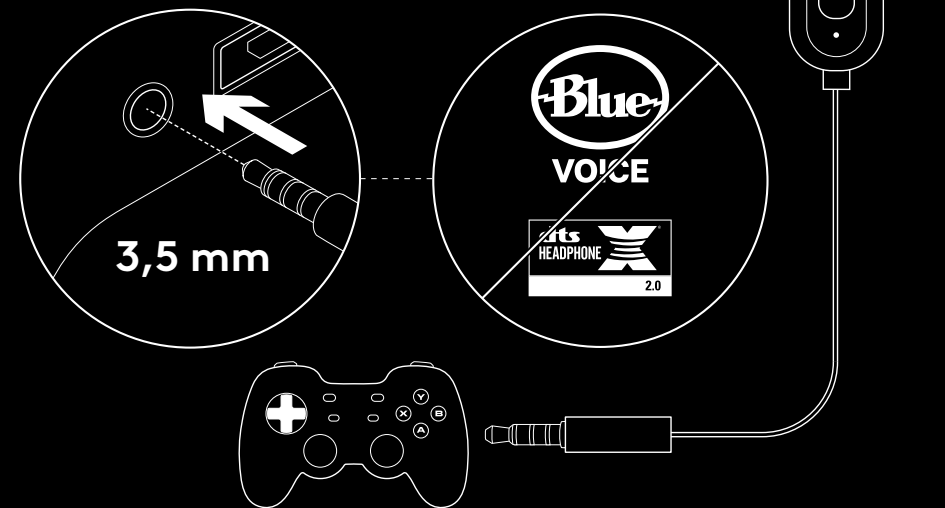

## POSITIONNEMENT DU MICROPHONE

Placez le microphone à proximité de la commissure des lèvres pour un fonctionnement optimal. Ainsi, votre voix peut être clairement entendue sans que le microphone ne capte les bruits de respiration.

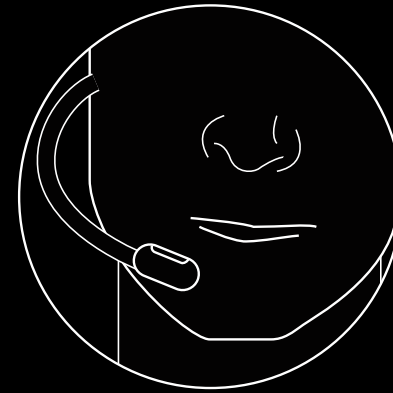

## QUESTIONS FRÉQUENTES

Q: Comment puis-je enregistrer un réglage d'égaliseur personnalisé sur le DAC USB?

A: Connectez le DAC USB au port USB d'un PC et utilisez le logiciel G HUB pour télécharger un égaliseur préconfiguré de votre joueur professionnel préféré ou pour configurer vos propres paramètres d'égaliseur personnalisés. Après avoir utilisé G HUB pour enregistrer votre égaliseur sur le DAC, vous pouvez ensuite profiter de vos paramètres personnalisés sur des PC de tournoi sans installer le logiciel G HUB.

Q: Puis-je enregistrer des paramètres Blue VO!CE sur le DAC USB?

A: Non, la technologie Blue VO!CE est uniquement disponible en utilisant le logiciel G HUB et le DAC USB sur PC.

Q: Puis-je enregistrer des paramètres DTS Headphone:X 2.0 sur le DAC USB?

A: Non, la technologie DTS Headphone:X 2.0 est uniquement disponible en utilisant le logiciel G HUB et le DAC USB sur PC.

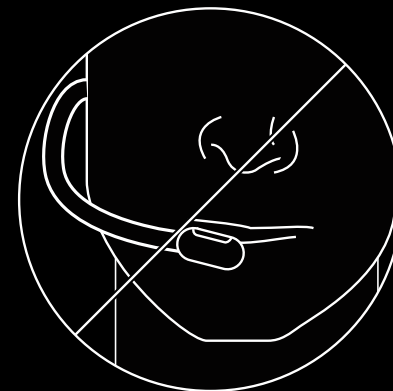

[www.logitechG.com/GHUB](http://www.logitechG.com/GHUB)

[www.logitechG.com/support/pro-x-se-headset](http://www.logitechG.com/support/pro-x-se-headset)



## CONFIGURACIÓN EN PC

- 1 Conecta el micrófono
- 2 Conecta el cable de consola/PC a los audífonos
- 3 Si se usa DAC USB:
  1. Conecta el cable de consola/PC al DAC USB
  2. Conecta el DAC USB a la PC<sup>1</sup>
- 4 Si se usa la tarjeta de sonido de la PC:
  1. Conecta el cable de consola/PC al divisor para PC
  2. Conecta el divisor para PC a los puertos de audífonos y micrófono de la PC

<sup>1</sup>El DAC USB incluido posibilita ajustar el ecualizador de 5 bandas, DTS Headphone:X 2.0 y filtros de micrófono Blue VO!CE en PC. Requiere descarga del software Logitech G HUB. El ajuste del ecualizador de 5 bandas, DTS Headphone:X 2.0 y Blue VO!CE no están disponibles cuando se usa la tarjeta de sonido de la PC.

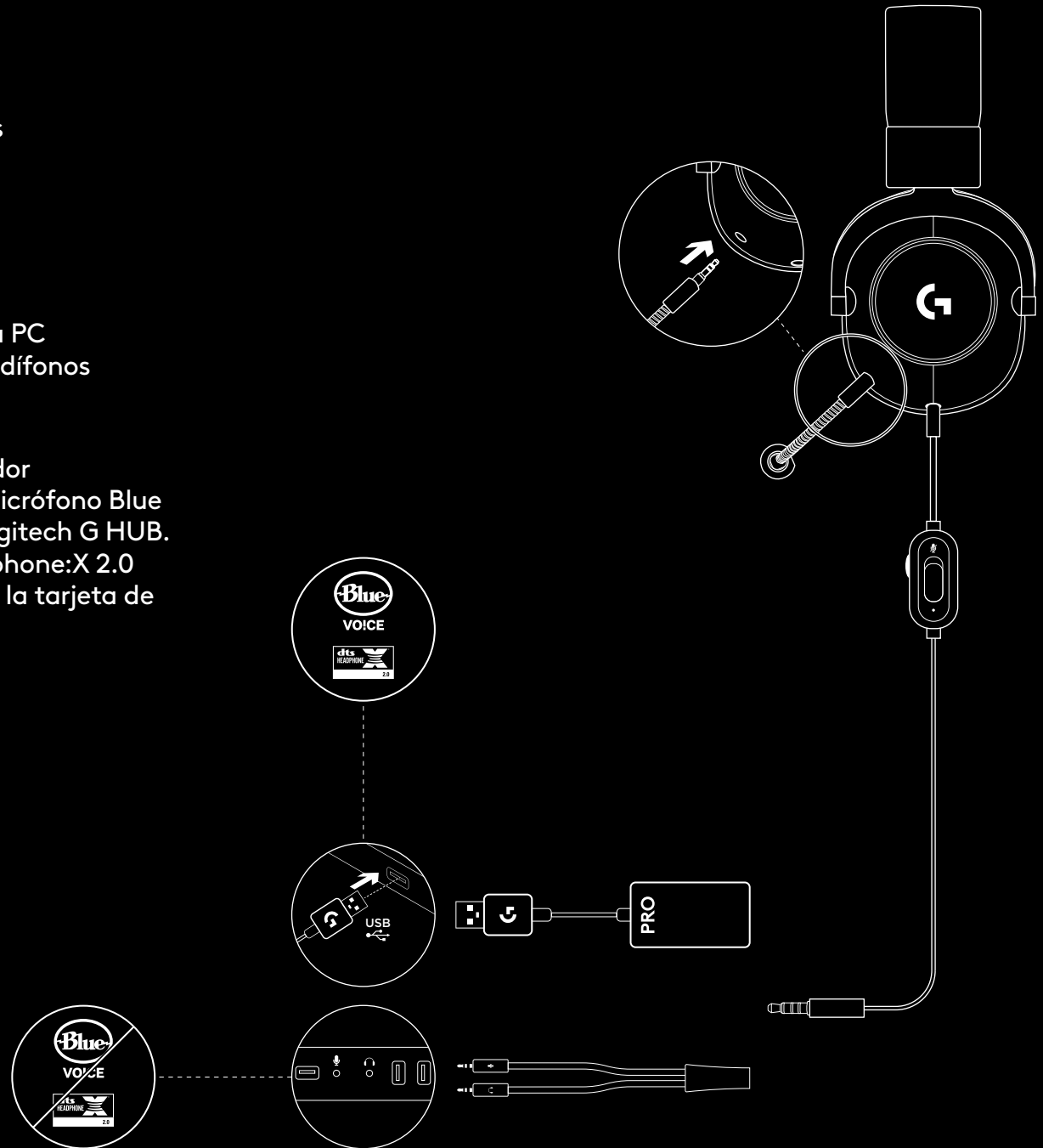

## CONFIGURACIÓN PARA CONSOLA (XBOX™, PLAYSTATION®)

- 1 Conecta el micrófono
- 2 Conecta el cable de consola/PC a los audífonos
- 3 Conecta el otro extremo al control<sup>2</sup>

<sup>2</sup> Las instrucciones pueden variar en función de la versión de tu sistema.

Consulta el manual de tu consola para obtener más información.

Xbox y PlayStation funcionan sólo en modo estéreo mediante cable analógico. Algunos controles de Xbox pueden requerir el adaptador para audífonos estéreo Xbox, a la venta por separado.

El ajuste del ecualizador de 5 bandas, DTS Headphone:X 2.0 y Blue VO!CE no están disponibles cuando se usa la conexión al control de la consola.

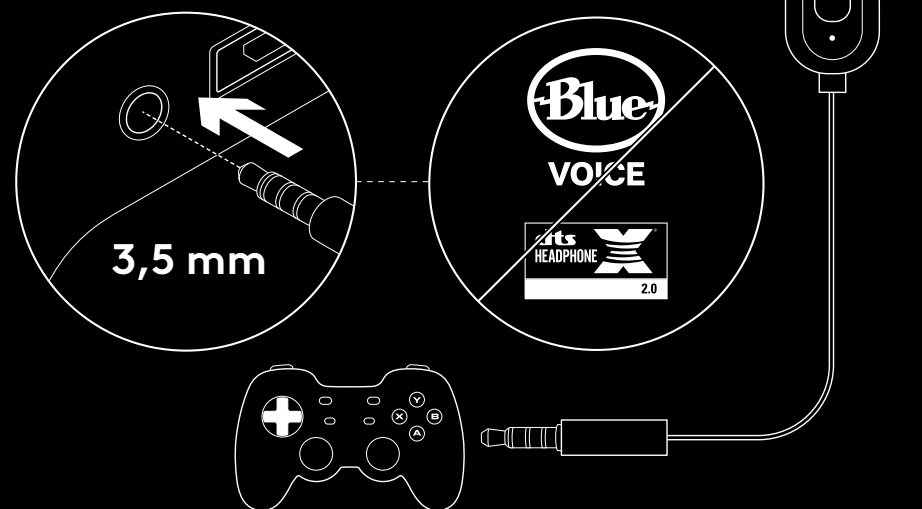

## COLOCACIÓN DEL MICRÓFONO

La colocación ideal del micrófono es en la comisura de los labios. En esta posición, tu voz se oye claramente sin que el micrófono capte los sonidos de la respiración.

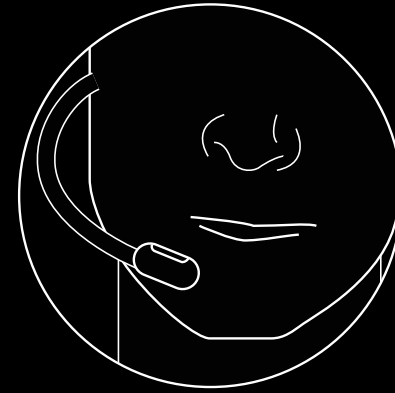

## PREGUNTAS MÁS FRECUENTES

P: ¿Cómo se guarda una ecualización personalizada en el DAC USB?

R: Conecta el DAC USB a un puerto USB de la PC y usa el software G HUB para descargar una EQ preconfigurada de tu jugador profesional favorito, o para configurar tu propia configuración de ecualizador. Después de usar G HUB para guardar tu EQ en el DAC, puedes empezar a disfrutar de tu configuración personalizada incluso en PC de torneos que no tengan instalado el software G HUB.

P: ¿Se puede guardar la configuración de Blue VO!CE en el DAC USB?

R: No, la tecnología Blue VO!CE sólo está disponible cuando se usan el software G HUB y el DAC USB en PC.

P: ¿Se puede guardar la configuración de DTS Headphone:X 2.0 en el DAC USB?

R: No, DTS Headphone:X 2.0 sólo está disponible cuando se usan el software G HUB y el DAC USB en PC.

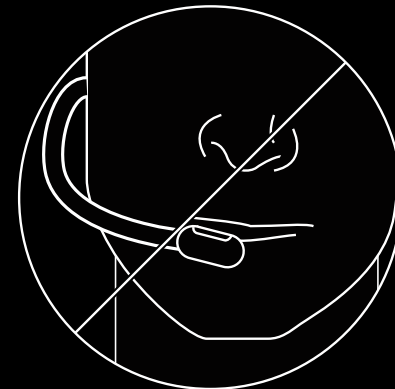

[www.logitechG.com/GHUB](http://www.logitechG.com/GHUB)

[www.logitechG.com/support/pro-x-se-headset](http://www.logitechG.com/support/pro-x-se-headset)

# CONFIGURAÇÃO DO PC

- 1 Conectar o microfone
- 2 Conectar o fio do console/PC ao headset
- 3 Uso do DAC USB:
  1. Conecte o fio do console/PC ao DAC USB
  2. Conecte o DAC USB ao PC<sup>1</sup>
- 4 Uso da placa de som do PC:
  1. Conecte o fio do console/PC ao adaptador para PC
  2. Conecte o adaptador para PC às portas do microfone e dos fones de ouvido do PC

<sup>1</sup>O DAC USB incluído habilita o ajuste do EQ de cinco faixas, os filtros do DTS Headphone:X 2.0 e do microfone Blue VO!CE no PC. Requer o download do software Logitech G HUB. O ajuste do EQ de cinco faixas, o DTS Headphone:X 2.0 e o Blue VO!CE não estão disponíveis ao usar a placa de som do PC.

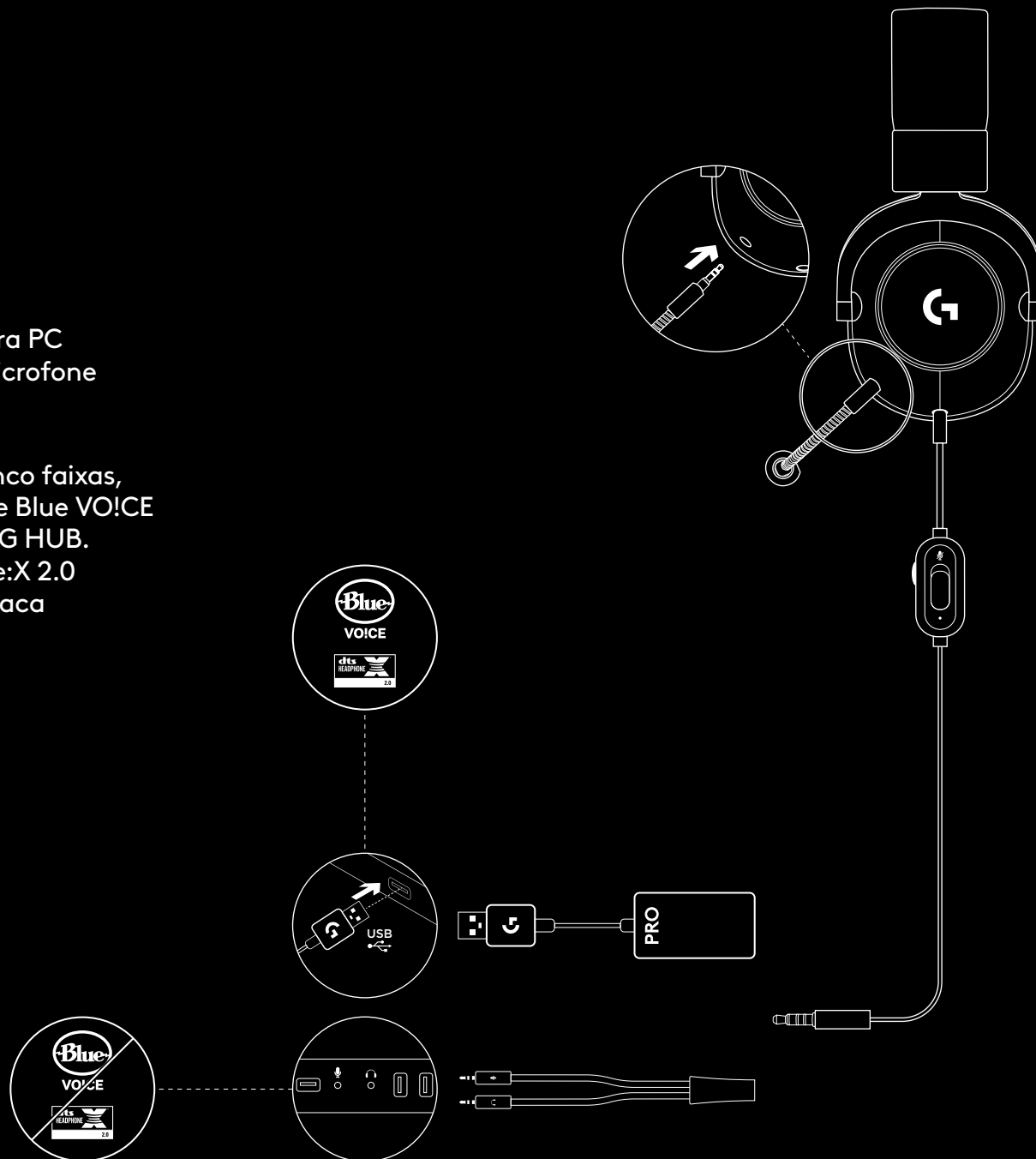

## CONFIGURAÇÃO DO CONSOLE (XBOX™, PLAYSTATION®)

- 1 Conectar o microfone
- 2 Conectar o fio do console/PC ao headset
- 3 Conectar outra extremidade ao controlador<sup>2</sup>

As instruções podem variar dependendo da versão do sistema. Verifique o manual do console para obter orientações adicionais.

O Xbox e o PlayStation operam apenas em modo estéreo via cabo analógico. Alguns controladores do Xbox podem precisar do adaptador estéreo para headset do Xbox, vendido separadamente.

O ajuste do EQ de cinco faixas, o DTS Headphone:X 2.0 e o Blue VO!CE não estão disponíveis quando conectados ao controlador do console.

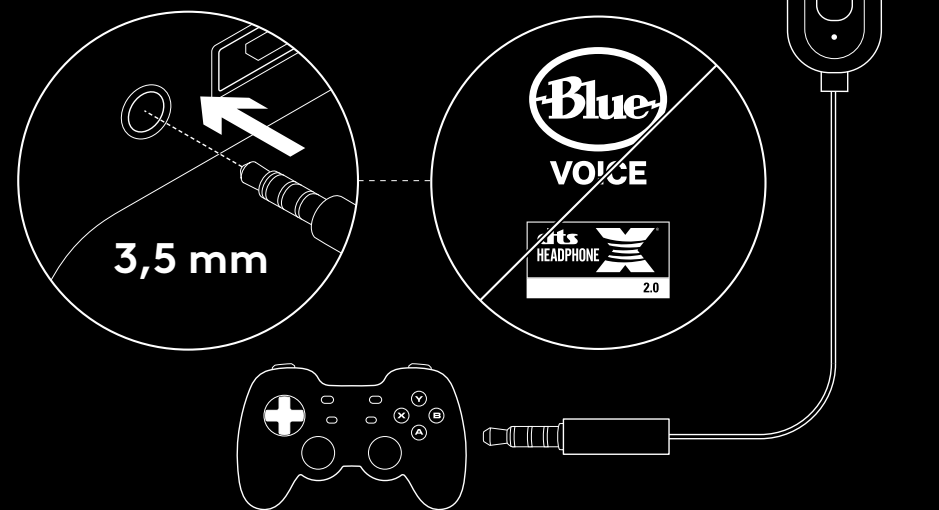

## POSIÇÃO DO MICROFONE

A posição ideal do microfone é no canto da boca. Nessa posição, sua voz pode ser ouvida nitidamente sem que o microfone capte o som da respiração.

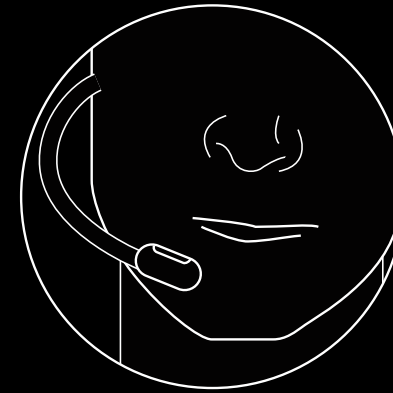

## PERGUNTAS FREQUENTES

P: Como salvo um EQ personalizado no DAC USB?

R: Conecte o DAC USB à uma porta USB do PC e use o software G HUB para baixar um EQ pré-configurado do seu gamer profissional favorito ou defina suas próprias configurações do EQ. Depois de usar o G HUB para salvar seu EQ no DAC, você pode desfrutar das suas configurações personalizadas inclusive em PCs de torneios sem o software G HUB instalado.

P: Posso salvar as configurações do Blue VO!CE no DAC USB?

R: Não, a tecnologia do Blue VO!CE está disponível apenas ao usar o software G HUB e o DAC USB no PC.

P: Posso salvar as configurações do DTS Headphone:X 2.0 no DAC USB?

R: Não, o DTS Headphone:X 2.0 está disponível apenas ao usar o software G HUB e o DAC USB no PC.

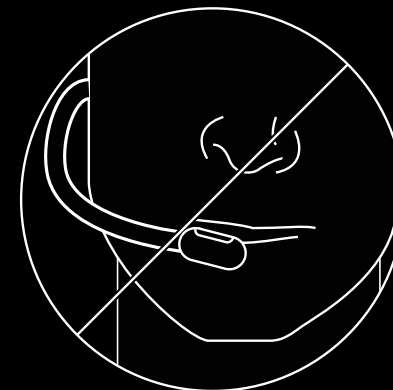

[www.logitechG.com/GHUB](http://www.logitechG.com/GHUB)

[www.logitechG.com/support/pro-x-se-headset](http://www.logitechG.com/support/pro-x-se-headset)



© 2024 Logitech, Logitech G, Logi and their respective logos are trademarks or registered trademarks of Logitech Europe S.A. and/or its affiliates in the U.S. and other countries. For DTS patents, see <http://patents.dts.com>. Manufactured under license from DTS Licensing Limited. DTS, the Symbol, & DTS and the Symbol together, Headphone:X, and the DTS Headphone:X logo are registered trademarks or trademarks of DTS, Inc. in the United States and/or other countries. All other trademarks are the property of their respective owners.

© 2024 Logitech, Logitech G, Logi et leurs logos respectifs sont des marques commerciales ou déposées de Logitech Europe S.A. et/ou de ses sociétés affiliées aux États-Unis et dans d'autres pays. Va sur <http://patents.dts.com> pour obtenir des informations sur les brevets de DTS. Fabrication sous licence de DTS, Licensing Limited. DTS, le symbole, DTS associé au symbole, Headphone:X et le logo Headphone:X sont des marques déposées ou des marques commerciales de DTS, Inc. aux États-Unis et/ou dans d'autres pays. Toutes les autres marques sont la propriété exclusive de leurs détenteurs respectifs.

WEB-621-002579 002